

A MATHEMATICAL STUDY OF MALARIA MODELS OF ROSS AND
NGWA

by

WILLIAM RODERICK PLEMMONS
BSEE, University of Central Florida, 1983
BSPsy, Jacksonville State University, 1975

A thesis submitted in partial fulfillment of the requirements
for the degree of Master of Science
in the Department of Mathematics
in the College of Sciences
at the University of Central Florida
Orlando, Florida

Fall Term
2006

©2006 William Roderick Plemmons

ABSTRACT

Malaria is a vector borne disease that has been plaguing mankind since before recorded history. The disease is carried by three subspecies of mosquitoes *Anopheles gambiae*, *Anopheles arabiensis* and *Anopheles funestu*. These mosquitoes carry one of four type of *Plasmodium* specifically: *P. falciparum*, *P. vivax*, *P. malariae* or *P. ovale*. [1] The disease is a killer; the World Health Organization (WHO) estimates that about 40% of the world's total populations live in areas where malaria is an endemic disease [2] and as global warming occurs, endemic malaria will spread to more areas. The malaria parasite kills a child every 30 seconds. [3] In Africa alone, as many as one million children die annually from malaria before they reach the age of 5. [4] The World Health Organization has an estimate of 100-200 million victims annually. [5] Malaria has many mathematical models and this paper will examine several different models in order to achieve a greater understanding of this disease.

TABLE OF CONTENTS

LIST OF FIGURES	v
LIST OF TABLES	vi
CHAPTER ONE - MALARIA	1
1.1 Introduction.....	1
1.2 Malaria in the United States.....	2
1.3 How malaria works in humans	3
CHAPTER TWO - MODELS	5
2.1 Types of models.....	5
2.2 SIR models.....	8
2.3 SIRS model.....	14
2.4 Some other types of models.....	14
2.5 Simulink representation of different models	17
CHAPTER THREE –SIR ROSS	19
3.1 Historical look at Sir Ronald Ross.....	19
3.2 Sir Ross’s model	20
CHAPTER FOUR – NGWA AND SHU.....	23
4.1 The model of Ngwa and Shu	23
4.2 Steady-State Solutions and Threshold Parameter	30
4.3 Stability of the system.....	37
CHAPTER FIVE - CONCLUSION	42
APPENDIX A SIMULINK OF NGWA AND SHU’S EQUATIONS.....	43
APPENDIX B MATLAB OF NWGA AND SHU’S EQUATIONS.....	45
APPENDIX C SIMULINK OF KERMACK AND MCKENDRICK SIR MODEL	48
APPENDIX D MATLAB CODE OF KERMACK AND MCKENDRICK SIR MODEL	50
APPENDIX E CLASSICAL SIR MATLAB CODE.....	52
APPENDIX F CLASSICAL SIR SIMULINK.....	55
APPENDIX G PREVENTION ON MALARIA	57
LIST OF REFERENCES.....	60

LIST OF FIGURES

Figure 1: Example of SEIRS flow	7
Figure 2: SIR Simulink plot of x values vs. time for equation 2.1	9
Figure 3: SIR Simulink plot of y values vs. time for equation 2.1	10
Figure 4: SIR Simulink plot of z values vs. time for equation 2.1	10
Figure 5: Simulation of Equation (1.3) y(t) vs. x(t) for equation 2.3	12
Figure 6: Simulation of Equation (1.3) y(t) vs. z(t) for equation 2.3.....	13
Figure 7: Simulation of Equation (1.3) x(t) vs. time for equation 2.3	13
Figure 8: Shonkwiler Plot of equation (2.7) r vs. t for various sigma [26].....	15
Figure 9: Matlab and Simulink version of Shonkwiler plot of equation (2.7) figure 14	18
Figure 10: Ngwa and Shu's graph showing long term behavior of equation (4.6)	27
Figure 11: Simulink solution for Ngwa and Shu's equation (4.6)	28
Figure 12: Ngwa and Shu's graph for long term vector populations	29
Figure 13: Simulink graph for solution of equation (4.6) long term vector populations.....	29
Figure 14: Simulink of Ngwa and Shu equations	44
Figure 15: Simulink model of Kermack and McKendrick SIR Equation (1.3)	49
Figure 16: Classical SIR model	56

LIST OF TABLES

Table 1: Terms of different classical Model types.....	6
Table 2: Terms use in the Ross model	20
Table 3: Terms used in Ngwa and Shu's model.....	23

CHAPTER ONE - MALARIA

1.1 Introduction

Malaria is a vector borne disease that has affected mankind since before recorded history. About 40% of the world's total population lives in areas where malaria is endemic disease and as global warming occurs that percentage will increase as mosquitoes ranges will increase due to increasing rainfall. The numbers of malaria victims are growing in number every year due to increasing resistance of the parasite to the drugs that have been used in the past to treat malaria and also due to the mosquitoes increasing resistance to the pesticides that once killed them.

The malaria parasite kills a child every 30 seconds.[6] In Africa alone, as many as one million children die annually from malaria before they reach the age of 5.[7] The World Health Organization has an estimate of 350-500 million victims infected annually, and killing an estimated 1,000,000 people per year[8] world wide.

The vector that spreads the parasite is the mosquito, but not just any mosquito, as only 30-50 species of the more than 430 species of mosquito spread parasite.[9] The major vectors for spreading the parasite are the mosquitoes: *Anopheles gambiae*, *Anopheles arabiensis* and *Anopheles funestus*. The vector, like the parasite, is also growing a resistance to the insecticides that have been used in the past to treat mosquitoes' breeding grounds. The parasite itself is a protozoan of the genus *Plasmodium* specifically: *P. falciparum*, *P. vivax*, *P. malariae* or *P. ovale*. [10] *Plasmodium falciparum* is the most deadly of the four types of malaria. Infection with *P. falciparum* is a medical emergency, about 2% of the people so infected die because of delayed treatment.[11]

Because of many factors, malaria is a disease that is in a resurgent phase. Due to an increase in air travel, a person who today is in Manaus, Brazil tomorrow can be in Miami, Florida,

and while he or she may not be showing any symptoms of malaria he or she could easily be a carrier of the parasite. The only way to be sure of the person's health status would be to perform a blood test for the parasite. An act as simple as recycling of automobile tires can add to the spreading of malaria. How you ask? Tires when left outside will be rained on and the rain water will collect in the tire. A female mosquito looking for a place to lay eggs will see this tire as a perfect breeding ground. Now the tire is put into a ship's hold and transported to another country for recycling. This act is how the Asia tiger mosquito made its way to the United States. While the tiger mosquito does not spread malaria it does spread other diseases. This method of movement could easily spread the *Anopheles* to areas were it currently does not exist.

Poverty while not a disease itself is a contributing factor in not only malaria but also for almost all diseases that face mankind. Because of poverty, communities may have poor sanitation and poor drainage and these two factors allow the mosquitoes to breed in greater and greater numbers. Poverty also means that the people will not be able to afford the simple protection of a mosquito net or even screens for their windows. A favorite hiding place for the *Anopheles* is in a dark moist room. With these increased numbers of vectors living with you comes an increased chance of being bitten by an infected mosquito which will in turn infect you with the parasite.

1.2 Malaria in the United States

At this time, malaria is essentially non-existent in the United States but that has not always been the case. Malaria has been endemic in the Southeastern United States until the late 1940's. When at that time, the National Malaria Eradication Program was proposed by Dr. L. L. Williams. The program commenced operations on July 1, 1947.[12] In the year 1914, there were an estimated 600,000 cases of malaria in the United States.[13] The disease was primarily

confined to 13 Southeastern states, with the application of DDT in over 4,650,000 household sprays and the control of the Tennessee River by dams built by the Tennessee Valley Authority. The vector that spread the disease was reduced by a significant numbers. Also the people who were infected were treated by use of various treatments and with this double barrel approach reducing both the vector and the parasite malaria was eliminated. While the *Anopheles* mosquitoes remain seasonally present in all states except Hawaii the disease is all but non-existent because of public health officials' relentless pursuit of those infected with the parasite.

While the United States does not currently have endemic malaria, the US is not immune. The CDC received reports of 1,278 malaria cases in 2003 and reports of 1,324 cases in 2004[14]. Four of these cases in 2004 were fatal and of these cases two were cause by *P. falciparum*, one by *P. vivax*, and one of *P. falciparum* mixed with *P. malariae*. One of the jobs of the CDC is to monitor malaria by tracking reported cases not only the primary case but to follow up with any secondary cases, doing blood tests on all, requiring treatment of those afflicted and following up to make sure that the positives take medication.

1.3 How malaria works in humans

Malarial infection is cyclic so we could start the cycle anywhere. In this case, an infected female mosquito bites a human host and injects the human with some of her saliva. The saliva acts as a pain killer so that the human will not feel the bite and because the female mosquito is infected her saliva contains the sporozoite form of the malaria parasite.

All blood in a human's body is filtered by the liver and here the sporozoite will reproduce in an asexual manner and forming large quantities of the trophozoite forms of the parasite. These trophozoites are released into the bloodstream where the red blood cells are invaded. The parasite uses the red blood cell as an incubator and again reproduces producing the merozoite

form of the parasite in quantities large enough to cause the cell to rupture. This process is repeated several times until the merozoite stage of the parasite produces the gametocyte (the sexual form) form of the parasite. On average the incubation period for the *P. falciparum* is about 12 days in humans and about 10 days in mosquitoes; other strains are normally longer.[15]

Again the female mosquito comes into play and bites the human and this time the mosquito's blood meal is infected with the merozoite. The merozoite penetrate the stomach wall of the mosquito and form oocysts, which later rupture and release sporozoites and migrate to the mosquito salivary glands ready to be injected into the next victim repeating the process ad infinitum. This female mosquito may or may not already be infected by sporozoites. If she is already infected this will lead to what is known as a superinfection, infected with multiple broods at the same time.

A detailed schematic for the complete life cycle of malaria can be found at:

http://www.cdc.gov/malaria/biology/life_cycle.htm .

CHAPTER TWO - MODELS

2.1 Types of models

A math model is a mathematical description of a real world system or event.[16] Models provide the user with concise descriptions of complicated non-linear systems. The model also provides a method for relating the process of infection of the individual to the process of infection of a population.[17] The modeler must have as much empirical data as possible and the only way to get that data is to have someone in the field collecting. The data will allow the scientist to develop a more detailed and accurate model and also allow the model to be tested seeing if predictions are correct. The model will provide the scientist a framework to allow him to place new knowledge in its correct place and with the correct emphasis, thereby; delineating critical areas that will need new research and maybe showing that older data was insufficient or incorrectly analyzed again showing needs for new work.

All resources are limited, therefore another need for a concise model is for correct placement of those limited resources to minimize human suffering from this disease. The well tuned model will allow better evaluation of the impact of new strategies for controlling the disease learning more quickly what works and what doesn't; therefore, the waste of valuable resources is minimized.

There are many types of mathematical models of disease SI, SIS, SIR, SIRS, SEIR, SEIRS and MSEIRS just to mention a few. Table one will define terms of the model types.

Table 1: Terms of different classical Model types

S	Susceptible
I	Infectious
E	Exposed (Infecteds)
R	Recovered (Immune)
M	Mother (Maternal Immunity)

- **M** This aspect of the model deals with the temporary immunity that a mother can pass on to her offspring via the placenta.
- **SI** This model indicates that all individuals in a class are susceptible to the disease and after being exposed the individual is infectious. This assumes that there is no incubation period and no recovery i.e. you stay infectious.
- **SIS** This model is similar to the SI model but the individual will not stay infectious instead he (she) will recover from the disease but will not acquire any immunity and reenter the susceptible group.
- **SIR** Again this model will use the base of the SI model but the individual will recover from the infection and gain immunity to the disease.
- **SIRS** This model will follow the SIR model except that the immunity gained is only temporary and after a small period of time the individual will again enter the susceptible category.
- **SEIR** In this model a person is susceptible to the infection and later exposed. There is a lag time between exposure and when you become infectious, but with time you recover and have immunity.

- **SEIRS** This model is the same as the SEIR model but the immunity is only a temporary phenomena.

Hence the flow of the disease will follow the SEIRS model

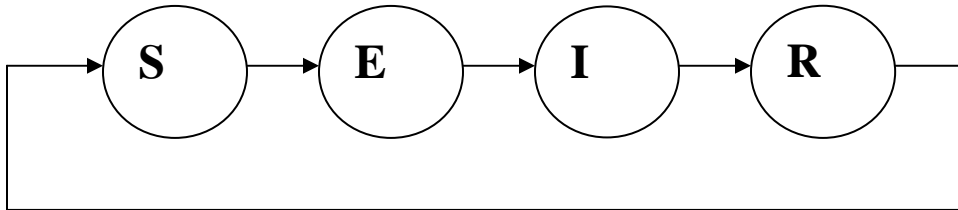

Figure 1: Example of SEIRS flow

Stochastic models rely on the individual chance and chance variations of the individual. Are you exposed to the disease? How great was your exposure and did you get a sufficiently large amount of the germ or an amount too small to cause the disease? A stochastic model will require very difficult and time consuming collection of data. These models are very difficult to set up and mathematically very difficult and complex. A deterministic model on the other hand is more related to explaining what happens to the general population. Hence the data collection is not concerned with what happens to the individual but what happens to the population as a whole. A deterministic model is neither as difficult nor as complex mathematically, compared with a stochastic model.

In general, a model will consist of a series of ordinary differential equations; these ODE's will relate various factors needed by the modeler to make a coherent model. The number of: humans, infected humans, mosquitoes, infected mosquitoes the rate of: mosquitoes biting infected humans, mosquitoes biting non infected humans, the birth rates of both, the death rates

of both, rainfall, drought, poverty are all elements that a modeler might take into consideration in his model.

2.2 SIR models

The classical SIR model by definition only has three classes of individuals: *S-susceptibles*, *I-infecteds* and *R-partial immunes*[18]. The assumptions associated with this model are: all who come into contact with the disease may contract the disease, those who contract the disease are at first severely symptomatic and later they either die or become mildly symptomatic and then they enter the *partial immunes* where they can not be re-infected as long as their immunity lasts. If these stages are denoted as x , y and z respectively then the following equations are proposed.

$$\begin{aligned}\frac{dx}{dt} &= -hx \\ \frac{dy}{dt} &= hx - ry \\ \frac{dz}{dt} &= ry\end{aligned}\tag{2.1}$$

Where h is the infection rate and r is the acquired immunity rate. Hence $1/h$ is the mean time until infection and $1/r$ is the mean time until immunity. Initial conditions for these assumptions say that:

$x(0) = 1$, and $y(0) = z(0) = 0$ and that

$$x(t) + y(t) + z(t) = 1 \quad t \geq 0\tag{2.2}$$

SIR GRAPHS
h=1:1:9

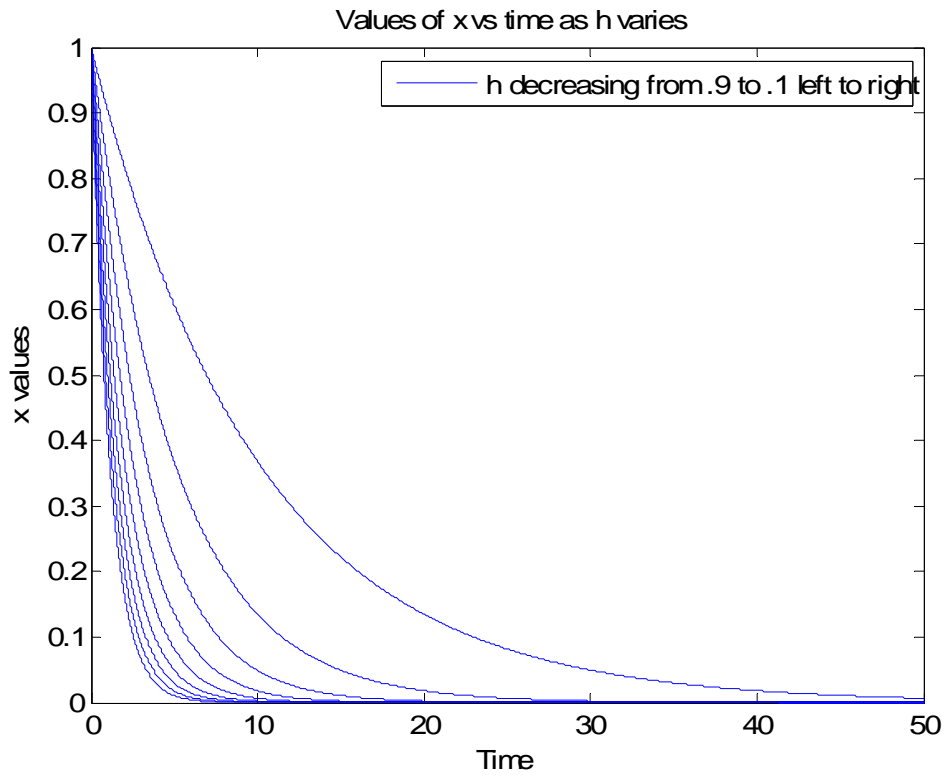

Figure 2: SIR Simulink plot of x values vs. time for equation 2.1

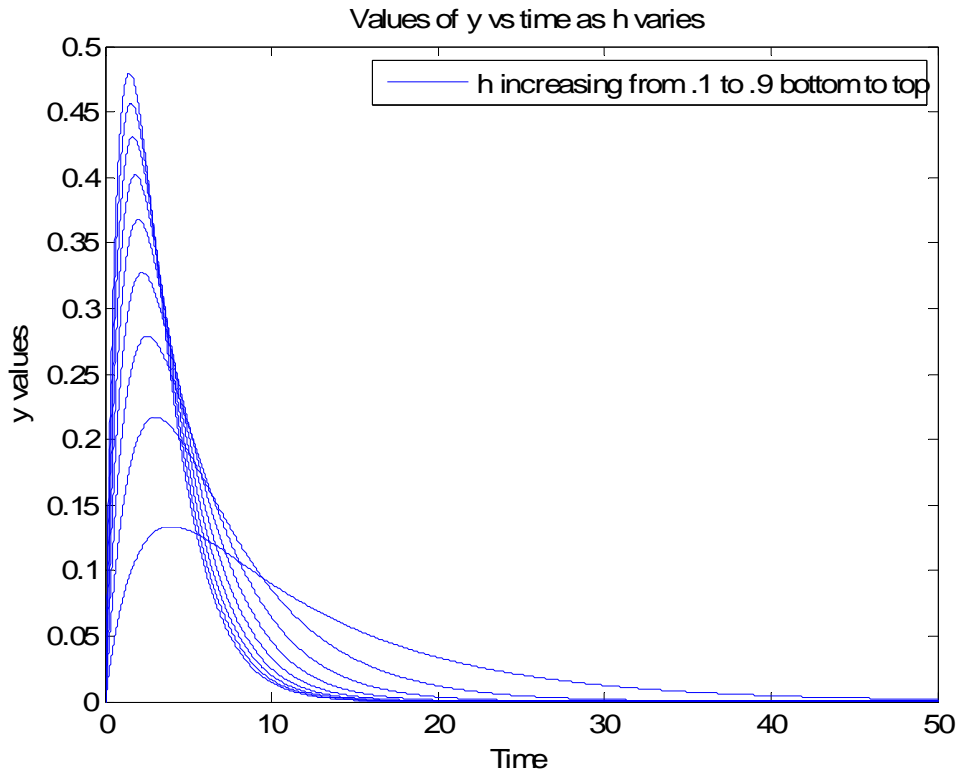

Figure 3: SIR Simulink plot of y values vs. time for equation 2.1

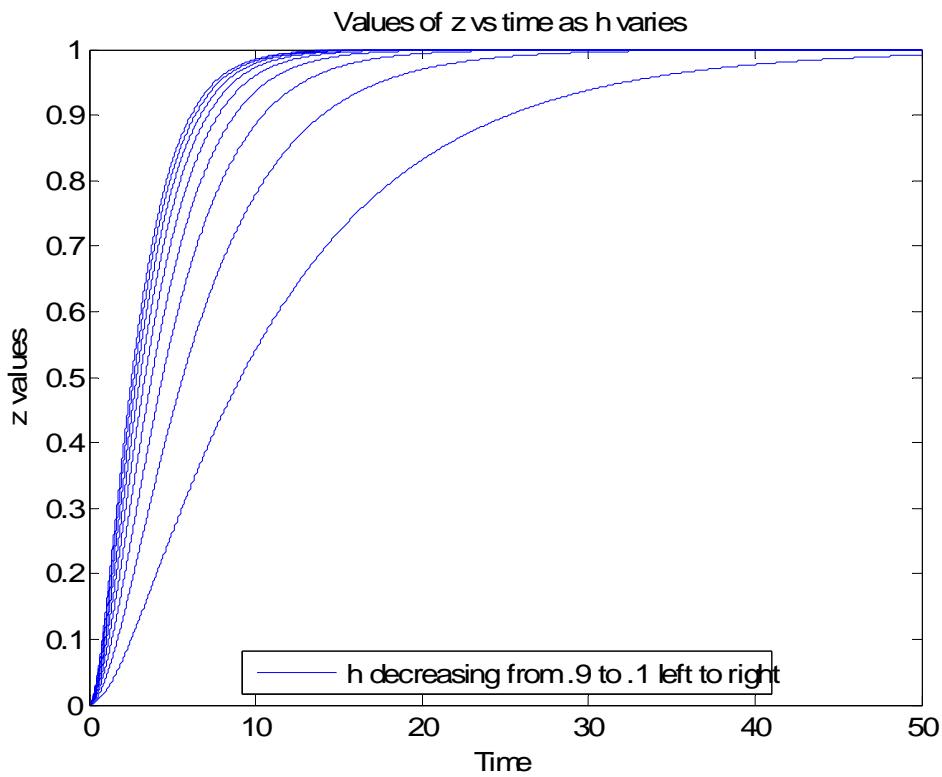

Figure 4: SIR Simulink plot of z values vs. time for equation 2.1

Another SIR model proposed by Kermack and McKendrick in 1927 is as follows:

$$\begin{aligned}\frac{dx}{dt} &= -hxy \\ \frac{dy}{dt} &= hxy - ry \\ \frac{dz}{dt} &= ry\end{aligned}\tag{2.3}$$

Kermack and McKendrick based this model on the following assumptions:

1. An average infective makes contact sufficient to transmit infection with hN other per unit of time, where N represents total population size.
2. A fraction r of infectives leave the infective class per unit of time.
3. There is no entry into or departure from the population, except possibly through death from the disease.[19]

Equation (2.3) is derived in the following manner. A susceptible must come into contact with an infective, who can transmit the infection to the susceptible. Then the steps needed to

algebraically manipulate these equations would be $(hN)\left(\frac{x}{N}\right)y = hxy$ where h is the rate of

transmission. This is equivalent to the rate of change of the susceptibles, hence the first line in equation (2.3). The second line is a combination of the first line and subtracting the amount of people leaving the infected group $hxy - ry$ where r is the rate of infectives leaving the group, hence line two in (2.3). Line 3 of (2.3) is simply the amount of the group entering the resistant group and from the previous lines of (2.3) that is ry .

The authors, Brauer and Chavez, use the model presented in equation (2.3) to model some plague data (this data can be seen at [20]). They used $S_0 = 254$, $I_0 = 7$, $S_\infty = 83$, $r = 2.73$ and

$h = 0.0178$ this data yields the following graphs. Equation (2.3) and this data will then be used to create the following plots.

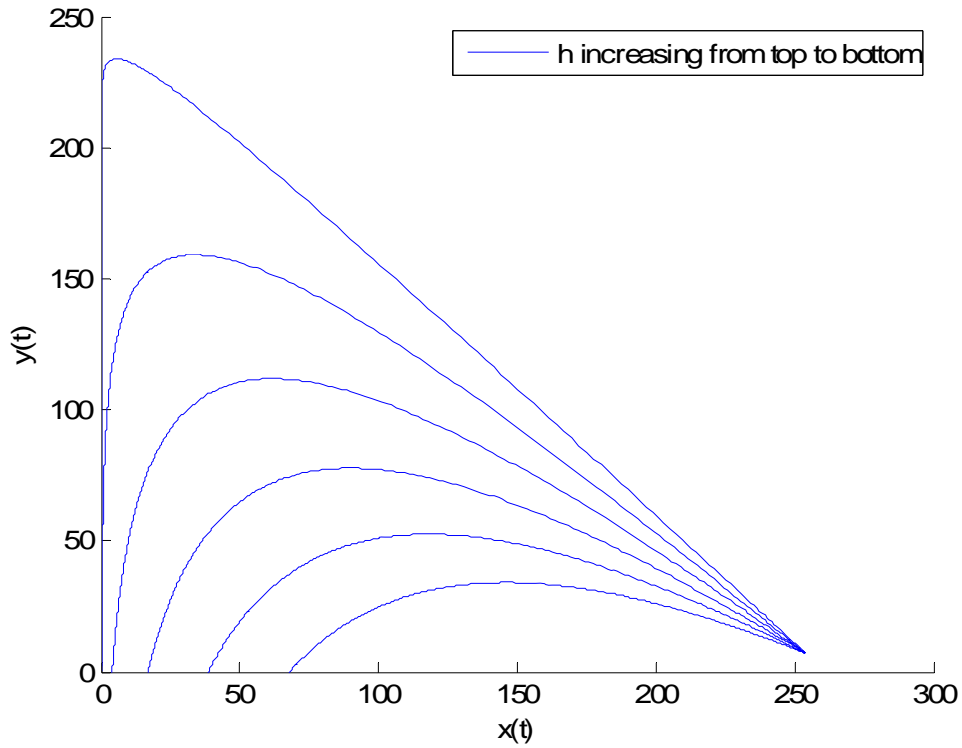

Figure 5: Simulation of Equation (1.3) $y(t)$ vs. $x(t)$ for equation 2.3

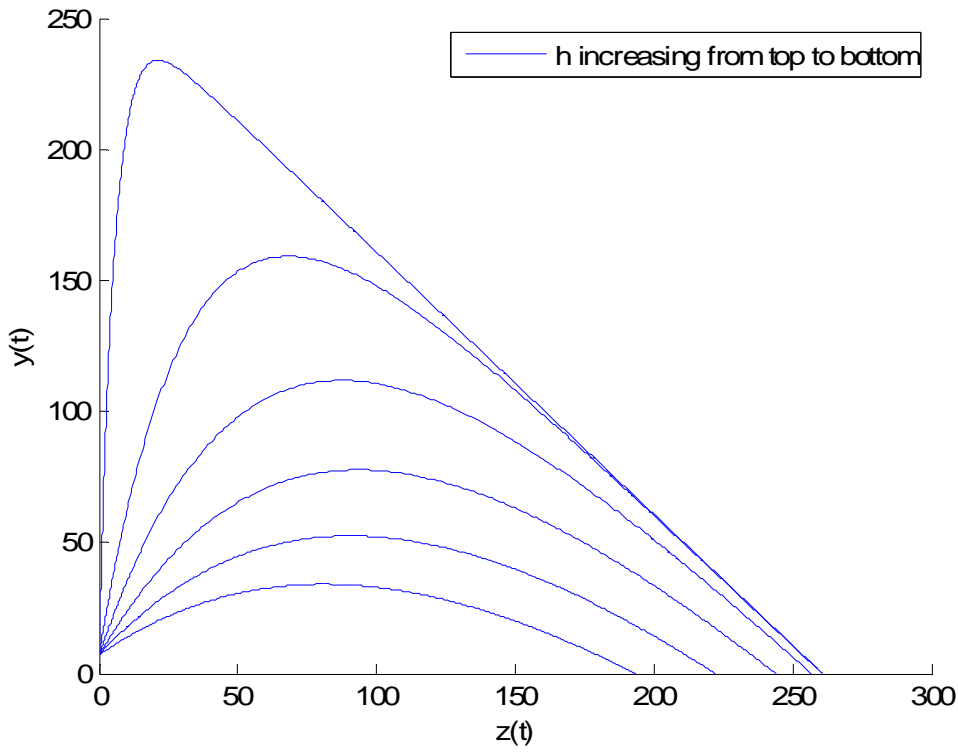

Figure 6: Simulation of Equation (1.3) $y(t)$ vs. $z(t)$ for equation 2.3

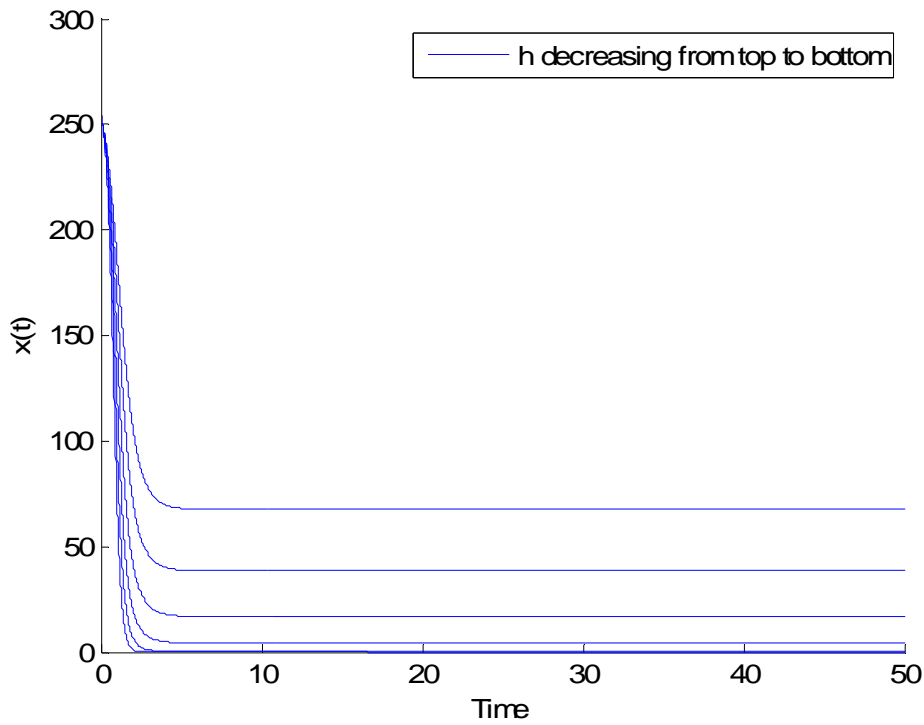

Figure 7: Simulation of Equation (1.3) $x(t)$ vs. time for equation 2.3

2.3 SIRS model

To generate the SIRS model the SIR model is changed by adding a return path ρy from the *partial immunes* to the *susceptibles*. Also added is a function γ of h which shows that the greater the rate of spread of the disease the greater the immunity will be within the population. This fact implies that as h increases γ should decrease leads us to the following equations given by the author.[21]

$$\gamma(h) = \frac{he^{-h\tau}}{1 - e^{-h\tau}} \quad (2.4)$$

The above changes combined with equation (2.1) yield the following equations to represent the classic SIRS model.

$$\begin{aligned} \frac{dx}{dt} &= -hx + \rho y + \gamma(h)z \\ \frac{dy}{dt} &= hx - \rho y - ry \\ \frac{dz}{dt} &= ry - \gamma(h)z \end{aligned} \quad (2.5)$$

$$x(t) + y(t) + z(t) = 1 \quad t \geq 0 \quad (2.6)$$

2.4 Some other types of models

The time dependent immunity (TDI) model [25] is a variation of the SIRS model that was reviewed earlier. In this model an assumption is made that a human can build up an immunity to malaria but that immunity is not immediate, as the immunity takes some time to develop. This

would mean that the immunity rate r is dependent on time $r = r(t)$ and that $r(0) = 0$ and the rate of exposure will be σ , with these considerations the following can be expressed by:

$$r = r_{\infty}(1 - e^{-\sigma t^2}) \quad (2.7)$$

The Shonkwiler gives the following plot of r versus t for various σ

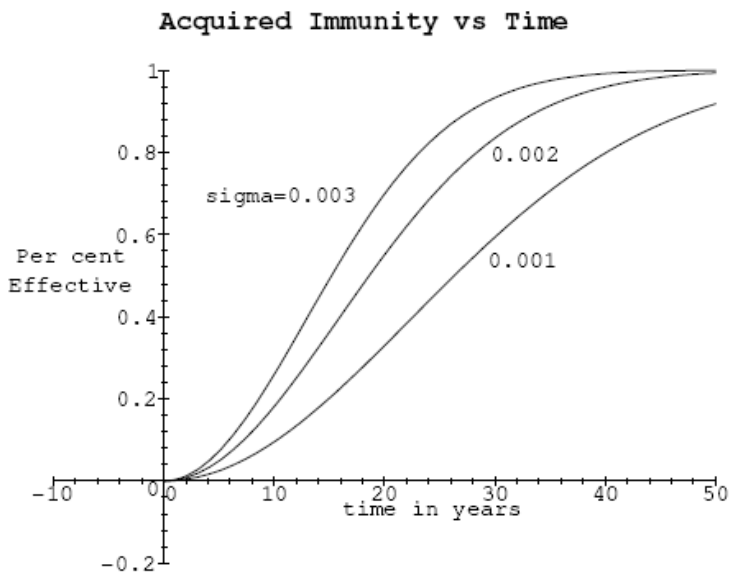

Figure 8: Shonkwiler Plot of equation (2.7) r vs. t for various σ [26]

Adding the acquired immunity equations into the previous defined SIRS equations leads to this new TDI model.

$$\begin{aligned} \frac{dx}{dt} &= -hx + \rho y + \gamma hz \\ \frac{dy}{dt} &= hx - \rho y - r_{\infty}(1 - e^{-\sigma t^2})y \\ \frac{dz}{dt} &= r_{\infty}(1 - e^{-\sigma t^2})y - \gamma hz \end{aligned} \quad (2.8)$$

Another model that can be considered is the temporary immunes (extended model) [27].

This model differs by the introduction of another subclass, w , those who have temporary immunity. The individuals in this subclass are different from those with partial immunity because they are completely recovered from malaria yet they still have strict immunity. The transition from infecteds to partial immunity or temporary immunity depend on many factors, individual differences, type of parasite, density and strain type of parasite. Starting with equation (2.2) and adding w with $w(0) = 0$ we now have the following equations for temporary immunes (extended model):

$$\begin{aligned}
 \frac{dx}{dt} &= -hx + \rho y + \gamma(h)z + \nu w \\
 \frac{dy}{dt} &= hx - \rho y - ry - py \\
 \frac{dz}{dt} &= ry - \gamma(h)z - sz \\
 \frac{dw}{dt} &= py + sz - \nu w
 \end{aligned}
 \tag{2.9}$$

$$x(t) + y(t) + z(t) + w(t) = 1, \quad x(0) = 1
 \tag{2.10}$$

Yet another model that is in use is *superinfection*. This model starts with the TDI model and assumes that there are a large number of vectors present in the environment and that before an individual can recover from one infection another vector will bite and you will have two broods of parasites introduced into the body at the same time. *Superinfection* is not limited to only two broods the infecteds can and often do have multiples of broods at once. The equations for superinfection are again related to equation (2.8) with the following differences, $\rho = \rho_1 + \rho_2$ and $r_\infty = r_{1\infty} + r_{2\infty}$.

$$\begin{aligned}
\frac{dx}{dt} &= -hx + \rho_1 y + \rho_2 y + \gamma(h)z \\
\frac{dy_1}{dt} &= hx - (h' + \rho_1 + r_{1\infty}(1 - e^{-\sigma t}))y_1 - \rho' y_2 \\
\frac{dy_2}{dt} &= h' y_1 - (\rho' + \rho_2 + r_{2\infty}(1 - e^{-\sigma t}))y_2 \\
\frac{dz}{dt} &= r_{1\infty}(1 - e^{-\sigma t})y_1 + r_{2\infty}(1 - e^{-\sigma t})y_2 - \gamma(h)z
\end{aligned} \tag{2.11}$$

These are just a few of the many variations of SIR and SIRS models that can be used by any author for modeling a variety of diseases like for example malaria, these models can be use in modeling smallpox[28].

2.5 Simulink representation of different models

Simulink can be use as a tool to perform some of the calculations and graphing use with some of the models in section 2.2. The following figure was produces using Matlab and Simulink and comparison to figure 8 shows very similar results.

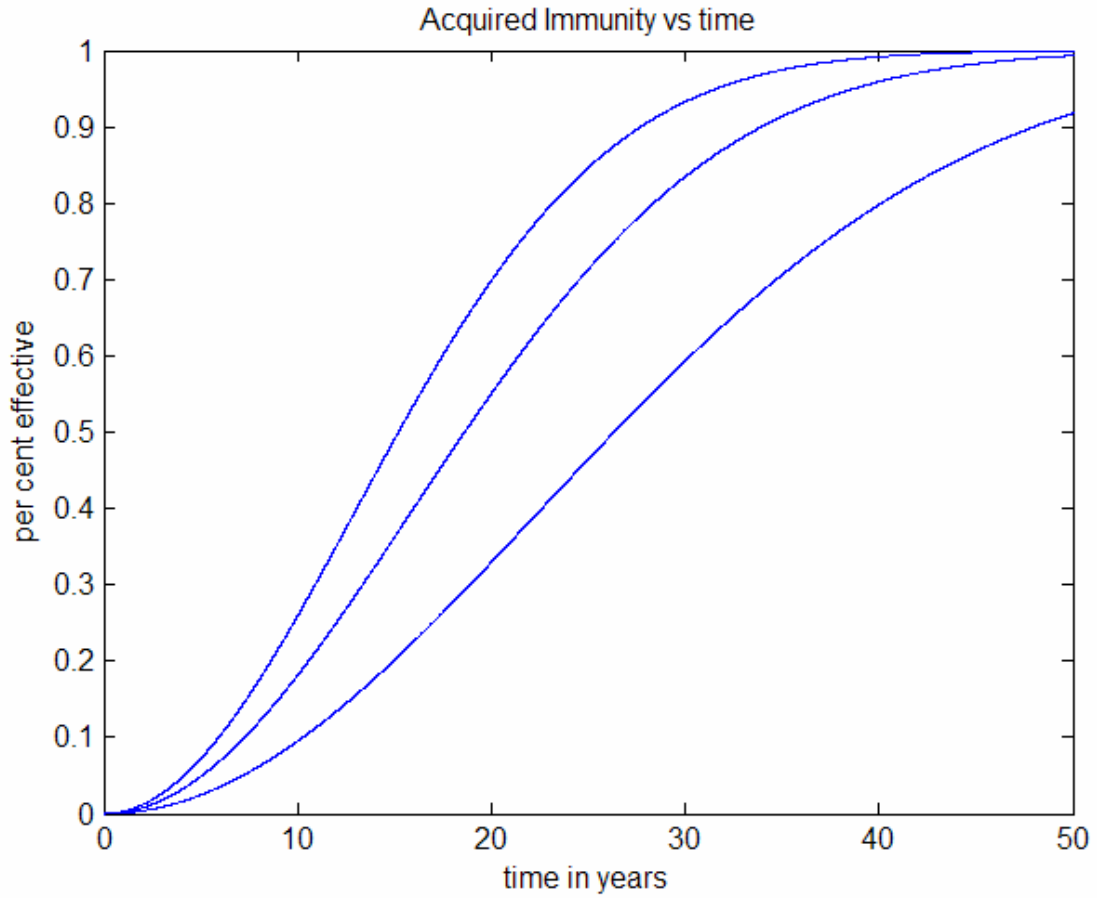

Figure 9: Matlab and Simulink version of Shonkwiler plot of equation (2.7) figure 14

CHAPTER THREE –SIR ROSS

3.1 Historical look at Sir Ronald Ross

The connection between mosquitoes and malaria was first made by Sir Ronald Ross. He was born in India on May 13, 1857 to a British army captain in the Bengal Army. Sir Ross was educated in England and then returned to India where he was commissioned into the Indian Medical Service. He first became interested in mosquitoes during the time that he was stationed in Southern India, when he was the food source for a large number of female mosquitoes (the female need protein from blood to aid the production of eggs the male only ingests plants juices). He traced his blood suckers to a water container that was right outside his window. His first attempt in mosquito control was to overturn that container of water. He tried to get all the men at the station to eliminate breeding places for mosquitoes but his suggestion was ridiculed.

Later he came down with malaria and after he recovered he decided that he needed to investigate more. When one of his assistants showed him a new species of mosquito he dissected this insect after it had fed from an individual that had malaria and he found “nothing – until he got to the stomach he found a clear and almost perfectly circular outline before me of about 12 microns in diameter. The outline was much too sharp, the cell too small to be an ordinary stomach-cell of a mosquito.”[22] Sir Ross had found for the first time ever the malaria *Plasmodium* in a mosquito. He took a 10 day leave to write a paper for the *British Medical Journal* and the paper was published three months later.

Sir Ross was the first person to prepare a scientific mathematical model of malaria based on his discoveries. He moved back to England in February 1899 and was later awarded a knighthood and the Nobel Prize for Medicine for his work with malaria.

3.2 Sir Ross's model

Sir Ross formulated his model for malaria in 1916.[23] His model had a basic deterministic formula. Using t to represent time; below is, with some minor changes, Ross's model for humans:

Table 2: Terms use in the Ross model

η	total human population size at a given time
y	total number of infected humans
f	proportion of infected humans who are also infectious
γ	recovery-rate for humans
μ	birth-rate for humans
ν	death-rate for humans
β_V	biting rate of mosquitoes biting humans

The same notation is also used but with subscript V, i.e η_V .. y_V , f_V , γ_V , μ_V and ν_V to denote the mosquito population.

Assuming that mosquitoes have a rate of biting man of β_V then in time Δt we have $\beta_V y_V f_V \Delta t$ infectious bites. The infectious bites divided by the number of susceptible humans is $\beta_V y_V f_V (\eta - y)/\eta \Delta t$ which would be the new human infection rate. The rate of recovery and the death rates added into the equation lead to the following differential equation:

$$\frac{dy}{dt} = \frac{\beta_V y_V f_V (\eta - y)}{\eta} - (\gamma + \nu)y \quad (3.1)$$

The same arguments could also be applied to the mosquito population and the following equation would result:

$$\frac{dy_v}{dt} = \frac{\beta_v f y (\eta_v - y_v)}{\eta} - (\gamma_v + \nu_v) y_v \quad (3.2)$$

The two equations are not symmetrical because the transmission of the disease from mosquito to man and vice versa is controlled by the habits of mosquitoes to bite humans and not humans biting mosquitoes, because of this fact we have only a β_v and not a β .

Ross made several assumptions in order to simplify and solve his equations. He concluded that in man ν (death-rate) was negligible compared with γ (recovery-rate) and that in the mosquito γ_v was negligible compared to ν_v . He also let the birth rate of the mosquito equal the death rate i.e. $\mu_v = \nu_v$. Using these approximations he rewrote the equations to:

$$\frac{dy}{dt} = \frac{\beta_v y_v f_v (\eta - y)}{\eta} - \gamma y \quad (3.3)$$

and

$$\frac{dy_v}{dt} = \frac{\beta_v f y (\eta_v - y_v)}{\eta} - \mu_v y_v \quad (3.4)$$

Now Ross again rewrote his equations in terms to malaria-rate in man, defined as $m = y/\eta$ and the density of infected mosquitoes per human as $u = y_v/\eta$ leading to:

$$\frac{dm}{dt} = \beta_v f_v u(1-m) - \gamma m \quad (3.5)$$

And

$$\frac{du}{dt} = \beta_v f m(a-u) + \mu_v u \quad (3.6)$$

Where $a \equiv \frac{\eta_v}{\eta}$. The trivial solution is $m = u = 0$ and is of little interest. A more interesting

solution is found by dividing both equations by mu and solving the resulting. This gives:

$$m = \frac{a\beta_v^2 ff_v - \gamma\mu_v}{\beta_v f(\gamma + a\beta_v f_v)} \quad (3.7)$$

and

$$u = \frac{a\beta_v^2 ff_v - \gamma\mu_v}{\beta_v f_v(\mu_v + \beta_v f)} \quad (3.8)$$

Lotka[24] studies of the stability of this solution. He found that $\frac{a\beta_v^2 ff_v}{\gamma\mu_v} \leq 1$ is stable and means

that if a few malaria cases are introduced into a malaria-free population no epidemic will begin

the disease will soon disappear. But if $\frac{a\beta_v^2 ff_v}{\gamma\mu_v} \geq 1$ then the introduction of a few cases will

result in an epidemic and cases will continue to increase till a secondary equilibrium is achieved.

CHAPTER FOUR – NGWA AND SHU

4.1 The model of Ngwa and Shu

The size and complexity of today models are staggering, as evidenced by the model that Gideon A. Ngwa came up with in his 1999 model. [29] The following terms are used in the Ngwa's model.

Table 3: Terms used in Ngwa and Shu's model

C_{hv}	respective infectivity of an infectious non-immune and partially immune human	t	time
C_{vh}	The infectivity of the mosquito	λ_h	Per capita human birth rate
a_v	The man biting rate of the mosquito	λ_v	Per capita mosquito birth rate
S_h	Susceptible humans	β_h	Rate a human loses his immunity
E_h	Incubating humans	v_h	Human during incubating period
I_h	Infectious humans	v_v	Mosquito during incubating period
R_h	Immune humans	r_h	Human recovery rate
S_v	Susceptible mosquitoes	$f_h(N_h)$	Per capita human death rate
E_v	Incubating mosquitoes	$f_v(N_v)$	Per capita mosquito death rate
I_v	Infectious mosquitoes	γ_h	Infected humans who die from the disease
N_h	The total human population	a_v	Average number of mosquito bite per unit time
N_v	The total mosquito population	$\frac{a_v N_v}{N_h}$	Number of bites per human per unit of time

Thus with the above definitions the authors derived the following few basic equations:

Humans infected per unit time is:

$$\left(\frac{c_{vh}a_v I_v}{N_h}\right)S_h \quad (4.1)$$

Mosquitoes infected per unit time is:

$$\left(\frac{c_{hv}a_v I_h}{N_h}\right)S_v + \left(\frac{c_{hv}a_v R_h}{N_h}\right)S_h \quad (4.2)$$

Similarly the authors said that following equations will describe the spread of the disease:

$$\begin{aligned} \frac{dS_h}{dt} &= \lambda_h N_h + \beta_h R_h + r_h I_h - f_h(N_h)S_h - \left(\frac{c_{vh}a_v I_v}{N_h}\right)S_h \\ \frac{dE_h}{dt} &= \left(\frac{c_{vh}a_v I_v}{N_h}\right)S_h - (v_h - f_h(N_h))E_h \\ \frac{dI_h}{dt} &= v_h E_h - (r_h + \alpha_h + \gamma_h - f_h(N_h))I_h \\ \frac{dR_h}{dt} &= \alpha_h I_h - (\beta_h + f_h(N_h))R_h \\ \frac{dS_v}{dt} &= \lambda_v N_v - f_v(N_v)S_v - \left(\frac{c_{hv}a_v I_h}{N_h}\right)S_v - \left(\frac{\bar{c}_{hv}a_v R_h}{N_h}\right)S_v \\ \frac{dE_v}{dt} &= \left(\frac{c_{hv}a_v I_h}{N_h}\right)S_v + \left(\frac{\bar{c}_{hv}a_v R_h}{N_h}\right)S_v - (v_v + f_v(N_v))E_v \\ \frac{dI_v}{dt} &= v_v E_v - f_v(N_v)I_v \end{aligned} \quad (4.3)$$

and

$$\begin{aligned}\frac{dN_h}{dt} &= \lambda_h N_h - f_h(N_h)N_h - \gamma_h I_h \\ \frac{dN_v}{dt} &= \lambda_v N_v - f_v(N_v)N_v\end{aligned}\tag{4.4}$$

All parameters in the model are assumed to be positive, $N_h > 0$ with $0 \leq \frac{S_h}{N_h}, \frac{I_h}{N_h}, \frac{R_h}{N_h} \leq 1$.

Ngwa also assumed that at $t = 0$ with $S_h(0) + E_h(0) + I_h(0) + R_h(0) = N_h(0)$, that there was a unique solution satisfying these initial conditions for all $t \geq 0$ with

$S_h(t) + E_h(t) + I_h(t) + R_h(t) = N_h(t)$ for all $t \geq 0$. Similar arguments could be made for the other expressions. Thus the system is well posed from a mathematical standpoint.

These equations describing the total vector population have at least two steady state solutions, the trivial solution of $N_v^* = 0$ and $N_v^* = \frac{\lambda_v}{f_v}$. Linearization about $N_v^* = 0$ yields the

linear approximation $\frac{dN_v}{dt} = (\lambda_v - f_v(0))N_v$. The linear death rate for mosquitoes $f_v(0)$ is

assumed to be $\lambda_v \geq f_v(0) \geq 0$ which implies that $\frac{\lambda_v}{f_v}$ exists and is nonnegative. Similar reasoning

can be applied to human death rates. Now Ngwa considers the non-diseased populations

with $f_v(N_v) = \mu_v + \mu_{2v}N_v$ and $f_h(N_h) = \mu_h + \mu_{2h}N_h$. To simplify calculations the following change

of variables is made $u = \frac{S_h}{N_h}, v = \frac{E_h}{N_h}, w = \frac{I_h}{N_h}, R = \frac{R_h}{N_h}, x = \frac{S_v}{N_v}, y = \frac{E_v}{N_v}, z = \frac{I_v}{N_v}$ and this yields

$u + v + w + R = 1 \Rightarrow v = 1 - u - w - R, x + y + z = 1 \Rightarrow y = 1 - x - z$. Ngwa now introduced a

rescaling of t with the quantity of $1/\mu_v$ by setting $\tau = \mu_v t$. The carrying capacities were

calculated as $N_h = \left(\frac{\lambda_h - \mu_h}{\mu_{2h}}\right)N_h^*$. A similar equation would relate to the vector. Dropping all of

the * the following dimensionless variables are introduced:

$$\begin{aligned}\tau &= \mu_v t, \lambda = \frac{\lambda_h}{\mu_v}, \beta = \frac{\beta_h}{\mu_v}, \gamma = \frac{\gamma_h}{\mu_v}, v = \frac{v_h}{\mu_v}, r = \frac{r_h}{\mu_v}, \\ \alpha &= \frac{\alpha_h}{\mu_v}, \varepsilon = \frac{\mu_h}{\mu_v}, \xi(N_h, N_v) = \frac{c_{vh} a_v \mu_{2h} (\lambda_v - \mu_v) N_v}{\mu_{2v} \mu_v (\lambda_h - \mu_h) N_h}, \\ a &= \frac{\lambda_v}{\mu_v}, b = \frac{c_{hv} a_v}{\mu_v}, c = \frac{c_{hv} a_v}{\mu_v}, e = \frac{v_v}{\mu_v}\end{aligned}\quad (4.5)$$

Using these definitions the equations of (4.3) become:

$$\begin{aligned}\frac{du}{d\tau} &= \lambda(1-u) + \beta R + rw + \gamma wu - \xi uz \\ \frac{dw}{d\tau} &= v(1-u-R) + \gamma w^2 - (r + \alpha + \gamma + \lambda + v)w \\ \frac{dR}{d\tau} &= \alpha w + \gamma wR - (\beta + \lambda)R \\ \frac{dx}{d\tau} &= a(1-x) - bxw - cxR \\ \frac{dz}{d\tau} &= e(1-x) - (a + e)z\end{aligned}\quad (4.6)$$

Note that Greek letters are reserved for human parameters.

An interesting note is that now the equations are with respect to $d\tau$, this means that the unit of time measurement is with respect to the life span of a mosquito which is about 21 days[30]. The equations for the total population now take on the following form:

$$\begin{aligned} \frac{dN_h}{d\tau} &= (\lambda - \varepsilon)(1 - N_h)N_h - \gamma N_h w \\ \frac{dN_v}{d\tau} &= (a - 1)(1 - N_v)N_v \end{aligned} \tag{4.7}$$

The variables now satisfy:

$$\Omega = \{u, w, R, z : 0 \leq U, w, R, x, z \leq 1, 0 \leq u + w + R \leq 1, 0 \leq x = z \leq 1\} \tag{4.8}$$

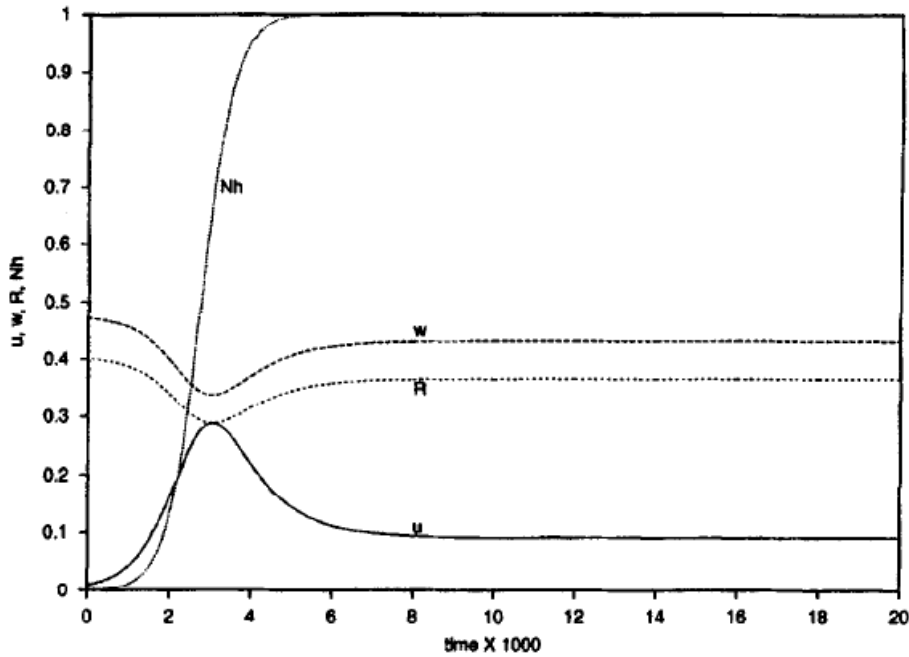

Figure 10: Ngwa and Shu's graph showing long term behavior of equation (4.6)

Note that the behavior shown for N_h in figure 10 is in error. The equilibrium is in error as $N_h = 1$ is not an equilibrium solution of equation (4.7) unless $w=0$. The correct value for N_h is shown in figure 11. and that value is about .3.

This graph shows the projected behavior of N_h , w , R , and u . Please recall that N_h is the total number of humans, $w \equiv \frac{I_h}{N_h}$, $R \equiv \frac{R_h}{N_h}$ and $u \equiv \frac{S_h}{N_h}$. Therefore this graph says that at about two to three thousand time units the respective values will rise or dip as shown and then at about seven thousand time units the values reach their steady state values.

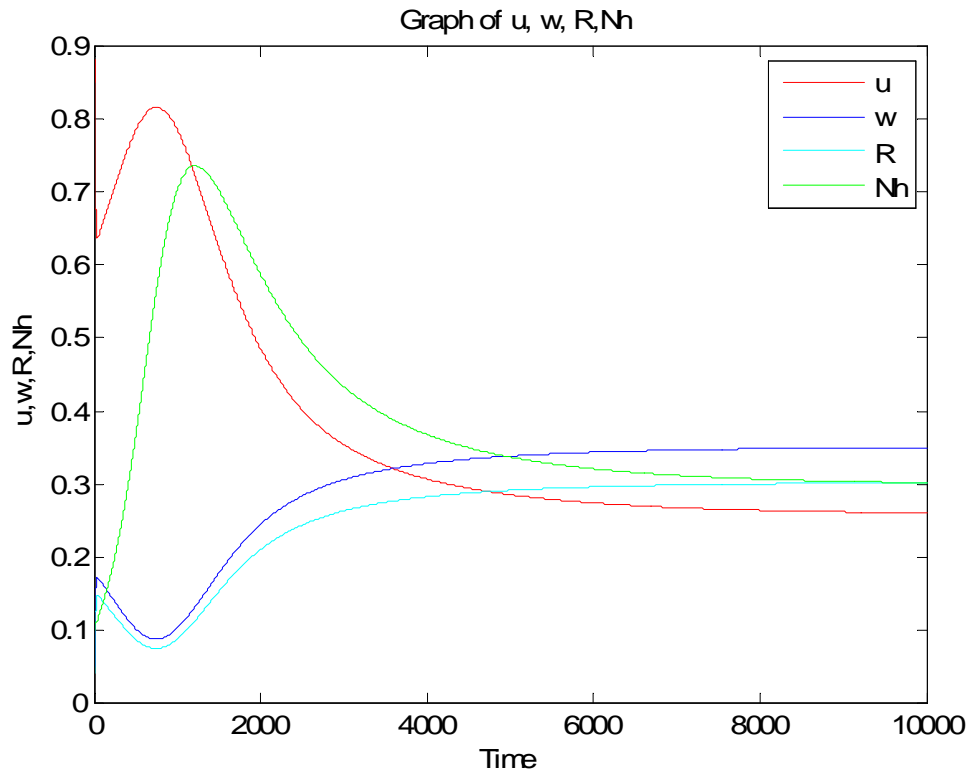

Figure 11: Simulink solution for Ngwa and Shu's equation (4.6)

The graph shown as figure 11 is a Simulink depiction of Ngwa and Shu's equation (4.6). While this graph differs from the graph presented earlier, we do get a similar shape in that we get a rise or fall of respective values of R , w and u . The value of N_h does not track with the original graph. We get an initial rise but then the values on N_h falls and reaches a steady state of about .3 not the value of 1 as in the original graph.

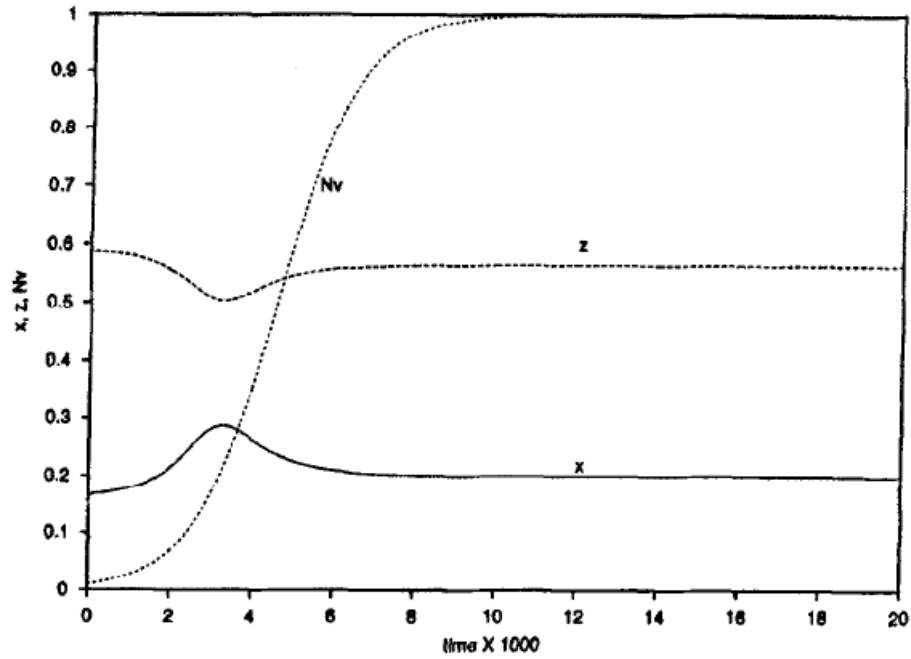

Figure 12: Ngwa and Shu's graph for long term vector populations

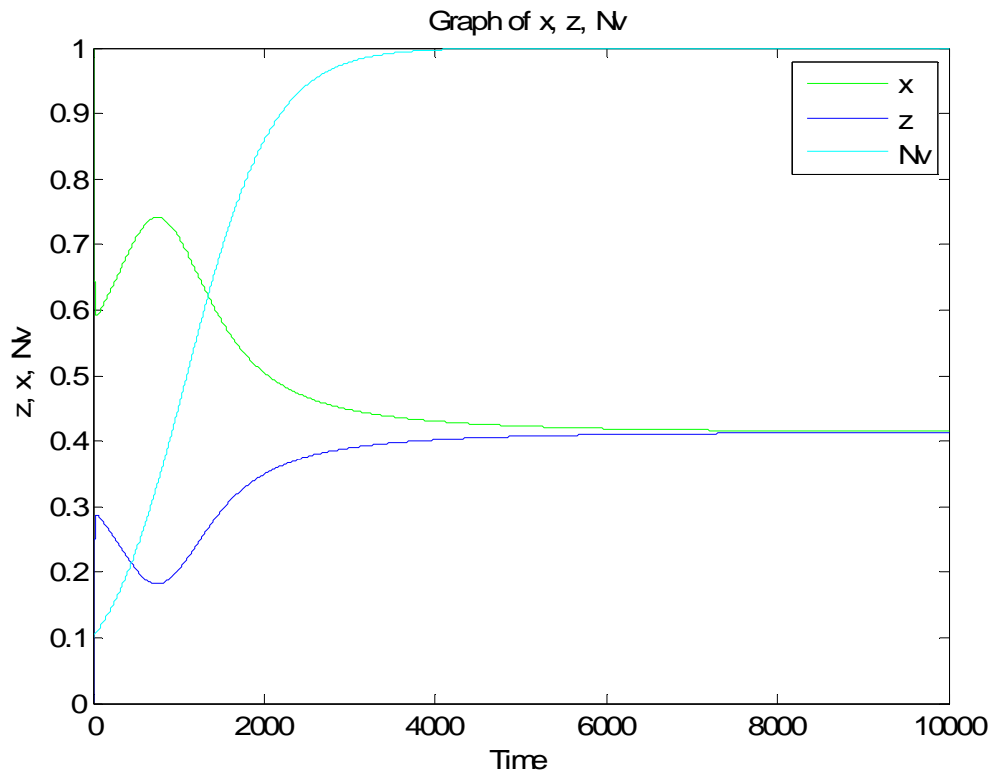

Figure 13: Simulink graph for solution of equation (4.6) long term vector populations

Figures 12 and 13 track each other well in shape. The graph shows similar deflections for x and z . The N_v values in both graphs go to 1 and stay there.

4.2 Steady-State Solutions and Threshold Parameter

At this point Ngwa introduces the existence of steady state in his model and to do this he introduces the concept of threshold parameter \tilde{R}_0 . Threshold parameter is also called basic reproductive number in other papers.[31] \tilde{R}_0 is defined as equation (4.9) below.

Proposition 1. Formulating the model in terms of proportions means that it has least one equilibrium solution $E : (u, w, R, x, a) = (u^*, w^*, R^*, x^*, z^*)$ with u^*, w^*, R^*, x^*, z^* nonnegative because of how they were defined and their existence and properties are determined by the threshold parameter \tilde{R}_0 . [32]

$$\tilde{R}_0 = \frac{\xi e v (\alpha c + b(\beta + \lambda))}{a(a + e)(\beta + \lambda)(\lambda + \nu)(\alpha + r + \gamma + \lambda)} \quad (4.9)$$

Equation (4.9) is found by taking equation (4.6) and setting its left hand side to 0 (because all transients disappear with sufficient passage of time) and then solving the resultant equations for the $*$ solutions (i.e. steady state).

$$\begin{aligned}
w^*(R^*) &= \frac{(\beta + \lambda)R^*}{\alpha + \lambda R^*} \\
u^*(R^*) &= 1 - R^* + \frac{(\beta + \lambda)R^*(\lambda(\beta + \lambda)R^* - M(\alpha + \gamma R^*))}{(\alpha + \lambda R^*)^2 \nu} \\
x^*(R^*) &= \frac{a(\alpha + \lambda)R^*}{a\alpha + (\alpha c + b(\beta + \lambda) + a\gamma)R^* + c\gamma R^{*2}} \\
z^*(R^*) &= \left(\frac{e}{a + e}\right) \frac{(\alpha c + b(\beta + \lambda) + c\gamma R^*)R^*}{a\alpha + (\alpha c + b(\beta + \lambda) + a\gamma)R^* + c\gamma R^{*2}} \\
v^*(R^*) &= 1 - u^*(R^*) - w^*(R^*) - R^* \\
y^*(R^*) &= 1 - x^*(R^*) - z^*(R^*)
\end{aligned} \tag{4.10}$$

Equation (4.10) is the steady state variable solution for equation (4.6). Substituting the values of u^* , w^* and z^* from equation (4.10) we get R^* is found by using the expressions of equation(4.9) in the first equation of (4.6), resulting in a sixth order equation (4.11).

$$R^*(A_5 R^{*5} + A_4 R^{*4} + A_3 R^{*3} + A_2 R^{*2} + A_1 R^* + A_0) = 0 \tag{4.11}$$

where

$$\begin{aligned}
A_5 &= acD\tilde{R}_0\gamma^4v^2\xi, \\
A_4 &= \gamma^3v(Ac(\beta + \lambda)(-B + a\beta(\beta + \lambda) + a\alpha v) + AD(c + a\tilde{R}_0)\xi \\
&\quad + cD\tilde{R}_0(B - a(\beta + \lambda)^2 + a(2\alpha - \gamma)v)\xi) \\
A_3 &= \gamma^2(A(\beta + \lambda)(A(-B + a\beta(\beta + \lambda) + a\alpha v) \\
&\quad + v(-B(c\alpha + a\gamma)) + a(\beta + \lambda)(a\beta\gamma - c\alpha\lambda) + a\alpha(c\alpha + a\gamma)v)) \\
&\quad D(A^2 + A\tilde{R}_0(B - a(\beta + \lambda)^2) + A(2c\alpha + a(2\tilde{R}_0\alpha + \gamma - \tilde{R}_0\gamma))v \\
&\quad c\tilde{R}_0\alpha v(2B - a(\beta + \lambda)^2 + a(\alpha - 3\gamma)v))\xi) \\
A_2 &= \alpha\gamma(A(\beta + \lambda)(-(A(B + a\lambda(\beta + \lambda) - a\alpha v)) \\
&\quad + a\gamma v(-2B + a(\beta^2 - \lambda^2 + 2\alpha v))) + D(2A^2 + A\tilde{R}_0(2B - a(\beta + \lambda)^2) \\
&\quad + A((c + a\tilde{R}_0)\alpha - 3a(\tilde{R}_0 - 1)\gamma)v + c\tilde{R}_0\alpha v(B - 3a\gamma v))\xi) \\
A_1 &= \alpha^2(-aA\gamma(\beta + \lambda)v(B + a\lambda(\beta + \lambda) - a\alpha v)) \\
&\quad + D(A^2AB\tilde{R}_0 - 3aA(\tilde{R}_0 - 1)\gamma v - ac\tilde{R}_0\alpha\gamma v^2)\xi) \\
A_0 &= aAD\alpha^3(1 - \tilde{R}_0)\xi
\end{aligned} \tag{4.12}$$

and with A, B, D and M defined as:

$$\begin{aligned}
A &= v(\alpha c + b(\beta + \lambda)), & B &= a(\alpha v + M(\beta + \lambda)), \\
D &= \frac{a}{\xi}(\beta + \lambda)(v(\alpha + \gamma + r) + \lambda M), \\
M &= \alpha + r + \gamma + v + \lambda
\end{aligned} \tag{4.13}$$

While there is a trivial solution of $R^* = 0$, this solution is of little interest in the investigation of threshold parameters. The more important solutions to this problem are shown in equation (4.11) with A_5 thru A_0 representing the various coefficients of R^* .

As noted prior all variables in the model are positive therefore A_5 is positive and the sign of A_0 depends on the sign of $(1 - \tilde{R}_0)$, if $\tilde{R}_0 > 1$ then $A_0 < 0$ signifying at least one sign change in the coefficients of R^* . Descartes Rule of signs indicates that there will exist at least one positive real root for equation (4.11), whenever $\tilde{R}_0 > 1$.

All that is required is that there is a solution $R^* \in [0,1]$ satisfying equation (4.11). When such a solution exists, the system is called realistic and the values for other steady states are given by equation (4.12). When $R^* = 0$ the steady state proposed by Proposition 1 is the solution $E_0 : (u, w, R, x, z) = (1, 0, 0, 1, 0)$, this is called the disease-free equilibrium (DFE). In other word when $\tilde{R}_0 > 1$ the disease will increase till a steady state is encountered, if on the other hand $\tilde{R}_0 < 1$ the disease will quickly fade away to obscurity.

Proposition 2. If $N_v = 0$ (the number of mosquitoes is zero) or any of ν , e , or ξ is zero then the only possible solution for R^* of equation (4.11) is zero and the model that has been formulated in terms of proportions has only the disease-free equilibrium of $E_0 : (u, w, R, x, z) = (1, 0, 0, 1, 0)$ as a constant solution. [33] Proof. If $N_v = 0$ then from equation (4.5), $\xi = 0$ and the first line of equation (4.6) shows that the only possible nonnegative solution for the system is E_0 .

Remark (i). Proposition 2 gives some conditions under which \tilde{R}_0 can vanish. The parameter ξ is a large grouping of several variables including the total vector and host populations, the condition that $\xi = 0$ can be interpreted several ways. First $\xi = 0$ could mean that the transmission rate from vector to host or host to vector is zero. Second $\xi = 0$ could mean that the vector or the host populations have dropped to zero. Equation (4.11) shows that the DFE always exists. When $\tilde{R}_0 > 1$, a second equilibrium different from the DFE is created, and is seen in Proposition 3.3.

Remark (ii). It is obvious that this makes sense even without mathematical backup because without the vector to spread the disease the disease can not exist hence the population is disease free.

Proposition 3. If $\tilde{R}_0 > 1$, then the condition of

$$\alpha\lambda - \beta\gamma \geq 0 \quad (4.14)$$

is a sufficient condition to guarantee the existence of at least one value $R^* \in (0,1)$ that solves equation (4.11). When $\tilde{R}_0 > 1$, the model formulated in terms of proportions has at least one realistic equilibrium solution different from the DFE, called the endemic equilibrium. When $\gamma = 0$, this new equilibrium, $E_{\gamma=0}$ is unique and is expressed in terms of \tilde{R}_0 . [34]

Proof. The function $g : R \rightarrow R$ defined by

$$g(R^*) = A_5 R^{*5} + A_4 R^{*4} + A_3 R^{*3} + A_2 R^{*2} + A_1 R^{*1} + A_0,$$

where the coefficients $A_5, A_4, A_3, A_2, A_1, A_0$ are those of equation (4.11). It is easy to show that $g(0) = A_0 = \frac{eavA^2\alpha^3}{a+e} \left(\frac{1-\tilde{R}_0}{\tilde{R}_0} \right)$. It follows that since all values are positive that $g(0) < 0$ when $\tilde{R}_0 > 1$. Now solving for $g(1)$ yields

$$\begin{aligned} g(1) = & (\beta + \lambda)(aM\tilde{R}_0(\alpha + \gamma)\lambda(\beta + \lambda)(c(\alpha + \gamma) + (\beta + \lambda))(M(\alpha + \gamma) - \gamma(\beta + \lambda)) \\ & + (M(\alpha + \gamma) - \gamma(\beta + \lambda))(-\beta\gamma + \alpha\lambda)(c\alpha + b(\beta + \lambda))(c(\alpha + \gamma) + b(\beta + \lambda)) \\ & + a(\alpha + \gamma)(c\beta(\tilde{R}_0\alpha(r + \alpha) + (r\tilde{R}_0 + (-1 + 2\tilde{R}_0)\alpha)\gamma + \tilde{R}_0\gamma^2) \\ & + c(\alpha + \tilde{R}_0(r + \alpha)) + \tilde{R}_0(r + 2\alpha)\gamma + \tilde{R}_0\lambda^2)\lambda + b(\beta + \lambda)(\tilde{R}_0(r + \alpha)\beta \\ & + (-1 + \tilde{R}_0)\beta\gamma + (\alpha + \tilde{R}_0(r + \alpha + \gamma))\lambda)))v \\ & + (\alpha + \gamma)^2(r + \alpha + \gamma)(c\alpha + b(\beta + \lambda))((a + c)(\alpha + \gamma) + b(\beta + \lambda))v^2 \end{aligned}$$

As stated before all variable values are positive, therefore when equation (4.14) is true, $g(1) \geq 0$ when $\tilde{R}_0 > 1$. The root $R^* \in (0,1)$ exists and this fact is bourn out by the intermediate value theorem. When $\gamma = 0$ equation (4.11) reduces to a first order equation in R^* and combining that fact with equations (4.12, 4.13) allow us to establish the new equilibriums of:

$$\begin{aligned} u^* &= \frac{A+B}{A+B\tilde{R}_0}, & w^* &= \frac{a\nu(\beta+\lambda)(\tilde{R}_0-1)}{A+B\tilde{R}_0} \\ R^* &= \frac{\nu\alpha a(\tilde{R}_0-1)}{A+B\tilde{R}_0}, & x^* &= \frac{A+B\tilde{R}_0}{(A+B)\tilde{R}_0} \\ z^* &= \frac{D(\tilde{R}_0-1)}{A+B}, \end{aligned} \quad (4.15)$$

which are realistic only when $\tilde{R}_0 > 1$ with $\tilde{R}_0 = 1$ giving the DFE.

The constant solutions proposed in Proposition 1 are only realistic if and only if they lie in the interval $[0,1]$. Calculations have shown that $R^* = 1$ can not happen because that would require u^* to be negative and that violates our basic assumption that all values are positive. We shall assume that $0 \leq R^* < 1$. This also requires that $w^* = 1$ not be allowed, thus restricting $0 \leq w^* < 1$. When we use these requirements in equation (4.10) the following results.

$$0 \leq w^* < 1 \Rightarrow 0 \leq \frac{(\beta+\lambda)R^*}{\alpha+\gamma R^*} < 1 \Rightarrow 0 \leq R^* \leq \frac{\alpha}{\beta+\lambda-\gamma} < 1 \quad (4.16)$$

The steady-state solutions for which the total human and vector populations are zero are unrealistic. You can see from equation (4.7) that when $\lambda < \varepsilon$ the human population tends to zero as $t \rightarrow \infty$. We will only consider the case of $\lambda > \varepsilon$ and again looking at equation (4.7) shows

that in the absence of disease, there is exponential growth in both populations near $N_h = 0$ and $N_v = 0$ and almost no growth when $N_h = 1$ and $N_v = 1$. As the disease causes deaths a new equilibrium for the total human population occurs. This equilibrium is set in part by the magnitude of γ . This equilibrium is derived by substituting the steady-state value of w^* into the right part of equation (4.7). Notice that if the γ (disease rate) is large enough the N_h (number of humans) gets very small.

$$N_h^* = 1 - \frac{\gamma}{\lambda - \varepsilon} w^* \quad (4.17)$$

Using w^* from equation (4.10) yields:

$$0 \leq N_h^* \leq 1 \Rightarrow 0 \leq R^* \leq \frac{(\lambda - \varepsilon)\alpha}{\gamma(\beta + \varepsilon)} \quad (4.18)$$

Thus the endemic equilibrium R^* exists and is a root of equation (4.11) and must satisfy

$$0 \leq R^* < \min\left\{1, \frac{(\lambda - \varepsilon)\alpha}{\gamma(\beta + \varepsilon)}, \frac{\alpha}{\beta + \lambda - \gamma}\right\} \quad (4.19)$$

This minimum exists when $\lambda \geq \varepsilon$ since $\beta + \lambda > \gamma$.

The disease can be considered under control in two ways. First the reservoir of infection is removed that is the I_h and the I_v populations are reduced to zero. The second way is for the proportions of w , z and R are reduced to zero.

The parameter \tilde{R}_0 is called the basic reproduction ratio and is usually defined as the expected number of secondary cases produced, in a susceptible population, by an infected individual during his entire period of infectiousness.

4.3 Stability of the system

The local stability of the system is found by taking equation (4.6) and using the steady state solutions of u^* , w^* , R^* , x^* , z^* . These values used with equation (4.6) yield the Jacobian matrix shown as equation (4.20) below.

$$J_E = \begin{pmatrix} \lambda w^* - \lambda - \xi z^* & r + \gamma u^* & \beta & 0 & -\xi u^* \\ -\nu & 2\gamma w^* - M & -\nu & 0 & 0 \\ 0 & \alpha + \gamma R^* & \gamma w^* - \beta - \lambda & 0 & 0 \\ 0 & -bx^* & -cx^* & -\frac{a}{x^*} & 0 \\ 0 & 0 & 0 & -e & -(a+e) \end{pmatrix} \quad (4.20)$$

Taking the determinant of equation (4.20) yields the fifth order equation (4.21).

$$\zeta^5 + a_1\zeta^4 + a_2\zeta^3 + a_3\zeta^2 + a_4\zeta + a_5 = 0 \quad (4.21)$$

Where a_1 thru a_5 of (4.21) are defined in equation (4.22):

$$\begin{aligned}
a_1 &= a + e + \frac{a}{x^*(R^*)} + (B_1 + B_2 + B_3) \\
a_2 &= \frac{a}{x^*(R^*)}(a + e) + (a + e + \frac{a}{x^*(R^*)})(B_1 + B_2 + B_3) \\
&\quad + B_1(B_2 + B_3) + B_2B_3 + \nu(B_4 + B_5) \\
a_3 &= \frac{a}{x^*(R^*)}(a + e)(B_1 + B_2 + B_3) \\
&\quad + (a + e \frac{a}{x^*(R^*)})(B_1(B_2 + B_3) + B_2B_3 + \nu(B_4 + B_5)) \\
&\quad + B_1(B_2B_3 + \nu B_4) + \nu(B_5B_3 + \beta B_4) \\
a_4 &= \frac{a}{x^*(R^*)}(a + e)(B_1(B_2 + B_3) + B_2B_3 + \nu(B_4 + B_5)) \\
&\quad + (a + e + \frac{a}{x^*(R^*)})(B_1(B_2B_3 + \nu B_4) + \nu(B_5B_3 + \beta B_4)) \\
&\quad - \xi e \nu u^*(R^*) x^*(R^*) (cB_4 + bB_3)
\end{aligned} \tag{4.22}$$

and with B_1 thru B_5 defined as:

$$\begin{aligned}
B_1 &= \lambda + \xi z^*(R^*) - \gamma w^*(R^*), & B_2 &= M - 2\gamma w^*(R^*), \\
B_3 &= \beta + \lambda - \gamma w^*(R^*), & B_4 &= \alpha + \gamma R^*, \\
B_5 &= r + \gamma u^*(R^*)
\end{aligned} \tag{4.23}$$

Now stability is shown if there exists a ζ such that there is a solution to (4.21) with $\Re(\zeta) > 0$. If such a ζ exists, then the equilibrium solution is locally unstable to small perturbations else it is locally and asymptotically stable. Using the steady-state solutions from equation (4.10) to generate new values of B_1 , B_2 and

$$\begin{aligned}
B_1 &= \lambda + \xi z^*(R^*) - \gamma w^*(R^*) = \xi z^*(R^*) + \frac{\lambda\alpha - \gamma\beta R^*}{\alpha + \gamma R^*} > 0, \\
B_2 &= M - 2\gamma w^*(R^*) = (\alpha + \nu + r) + \frac{\lambda\alpha - \gamma\beta R^*}{\alpha + \gamma R^*} + \gamma(1 - w^*(R^*)) > 0, \\
B_3 &= \beta + \lambda - \gamma w^*(R^*) = (\beta + \lambda)\left(1 - \frac{\gamma R^*}{\alpha + \gamma R^*}\right) > 0
\end{aligned}$$

since equation (4.14) $\alpha\lambda - \beta\gamma \geq 0$ and $0 \leq w^*, R^*, x^* < 1$. Therefore all coefficients are positive.

Coefficients a_1 , a_2 and a_3 are always positive and a_4 and a_5 could be negative or positive depending on the size of their negative parts. However given equations (4.14) and (4.16) and the original expression of \tilde{R}_0 in equation (4.9) it can be shown that whenever $\tilde{R}_0 > 1$, both a_4 and a_5 are positive. Since there is no sign change there are no positive real roots of equation (4.21).

Proposition 4. The disease-free equilibrium is locally and asymptotically stable when $\tilde{R}_0 < 1$. When $\gamma = 0$ and $\tilde{R}_0 > 1$, the unique endemic equilibrium $E_{\gamma=0}$, given by Proposition 3.3 is also locally and asymptotically stable.[35]

Proof. Substituting the value $R^* = 0$ into equation (4.21) will allow us to check the stability of the disease free equilibrium. As stated and shown prior coefficients a_1 , a_2 and a_3 are always positive a_4 and a_5 could be negative or positive. Now we want to investigate more closely the values of a_4 and a_5 showing that they are positive when $\tilde{R}_0 < 1$ and $R^* = 0$. These coefficients can be shown to be positive by taking the value of ξ from equation (4.9) and then using this value and $R^* = 0$ in a_4 and a_5 . Now having shown that all of the coefficients are positive and applying these values into a Routh-Hurwitz matrix[36] shows that the system has local stability.

Proposition 5: The disease free equilibrium is globally and asymptotically stable if

$$\tilde{R}_0 \leq 1. [37]$$

Proof: Consider the function $\ell : \Omega \times [0, \infty) \rightarrow \mathbb{R}$ defined by

$$\ell = \frac{\lambda}{\lambda + \nu}(R + w) + \frac{\nu}{\nu + \lambda}(1 - u) + \frac{a}{a + e}z + \frac{e}{a + e}(1 - x). \quad (4.24)$$

Since all of the values in (4.24) are positive and u and x are defined as proportionals being less than one, $\ell > 0 \forall (u, w, R, x, z) \in \Omega \setminus \{E_0\}$ where Ω is as defined by equation (4.8) and $\{E_0\}$ is the singleton $\{(1, 0, 0, 1, 0)\} \in \Omega$. Taking the first derivative of ℓ with respect to τ yields:

$$\begin{aligned} \frac{d\ell}{d\tau} &= \left(\frac{eb}{a+e} - (r+\lambda)\right)w + \left(\frac{ec}{a+e} - (\beta+\lambda)\right)R \\ &+ \left(\frac{\xi\nu}{\lambda+\nu} - a\right)z - \gamma Ru - \frac{\gamma\lambda}{\lambda+\nu}w\nu - \left(\frac{\xi\nu}{\lambda+\nu} + \frac{ec}{a+e}\right)Rz \\ &- \left(\frac{\xi\nu}{\lambda+\nu} + \frac{eb}{a+e}\right)wz - \frac{\xi\nu}{\lambda+\nu}\nu z - \left(\frac{eb}{a+e}w + \frac{ec}{a+e}R\right)y \end{aligned} \quad (4.25)$$

Solving equation (4.25) for b , c and ξ to show that the derivative of ℓ is non-positive whenever

$$b \leq \frac{(r+\lambda)(a+e)}{e}, \quad c \leq \frac{(\beta+\lambda)(a+e)}{e}, \quad \xi \leq \frac{a(\lambda+\nu)}{\nu} \quad (4.26)$$

ℓ is a Liapunov function for the system and from the definition of the Liapunov function assures us stability. [38] All paths in $\Omega \setminus \{E_0\}$ approach the largest positively invariant subset

$\tilde{\Omega} \subset \Omega$ where $\frac{d\ell}{d\tau} = 0$. $\tilde{\Omega}$ is the set $\{(w = 0, R = 0, z = 0)\}$. Therefore $(w, R, z) \rightarrow (0, 0, 0)$ as $\tau \rightarrow \infty$.

Propositions 4 and 5 show that there are two equilibrium points: one where the disease has died out the DFE implying $\tilde{R}_0 < 1$ and the other is the endemic equilibrium where $\tilde{R}_0 > 1$. \tilde{R}_0 is the unique threshold parameter that determines the behavior of the system and may we always live in an area where $\tilde{R}_0 < 1$ therefore all diseases will not establish themselves and will quickly fade away.

CHAPTER FIVE - CONCLUSION

Malaria is a disease that is constantly changing. The parasite and the vector are adapting to the treatments use in the past. As global warming occurs new areas will become endemic requiring change to confront the new conditions. Therefore, a model that accurately predicts what results new treatments will produce would be an invaluable tool for the proper allocation of resources.

A major problem with all models is that the model is not real time. Data used within a model must always be historical data and conditions could have changed from the time the data was gathered and the time the data is used.

The Ngwa and Shu model that was examined within this paper has a problem that should be addressed. The value of $N_h = 1$ is not an equilibrium solution of equation (4.7) unless $w=0$ and that is not always the case. The equilibrium value of equation (4.7) should be evaluated and a correction to the Ngwa and Shu paper should be submitted to the original publisher of the paper.

Current research into vector mosquitoes is one area that modeling could investigate. There have been found (see appendix g) *Anopheles* mosquitoes that are immune to *Plasmodium*. Modeling what the release of massive quantities of these resistance mosquitoes into the environment could predict whether or not the expense of such a program would be worth the expense involved. Another area of modeling that could be investigated is increase rainfall due to global warming. Increased rain could mean areas for mosquitoes to breed hence more mosquitoes and more malaria. Modeling could be applied to these and other new problems to predict where resources should be spent to best handle these new situations.

APPENDIX A
SIMULINK OF NGWA AND SHU'S EQUATIONS

Simulink version of
Ngwa and Shu
equations 9 and 10

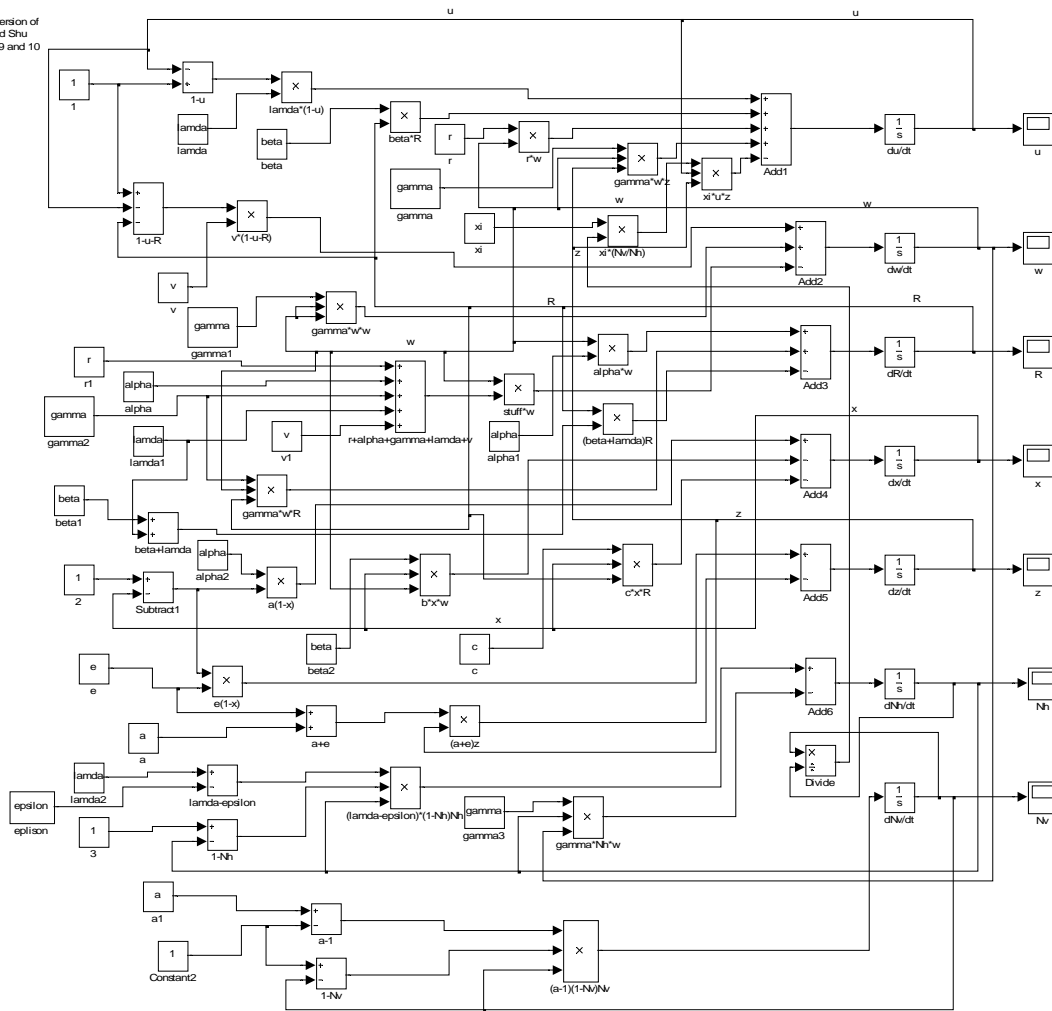

Figure 14: Simulink of Ngwa and Shu equations

APPENDIX B
MATLAB OF NWGA AND SHU'S EQUATIONS

```

clear all
close all
clc
% This set of data will product figure 1 from Ngwa and Shu's paper
% for beta=0.01:0.01:0.05
beta=0.35;

gamma=0.01;

%Initial conditions
u_initial=.01;
w_initial=.5;
R_initial=.4;
x_initial=.999999;
z_initial=.000001;
Nh_initial=.05;
Nv_initial=.05;

%Stop time for simulation
stop_time=10000;

xi=.5;
% for xi=.4:.1:3

alpha=.3;
% for alpha=.1:.1:.3

r=.2;
% for r=.01:.05:.2

lamda=.00184;
% for lamda=.0001:.0005:.00184

v=2;
% for v=.1:.5:3

b=10;
% for b=1:1:10

c=b/10;
epsilon=lamda-.005;
a=1.002;
% for a=.1:.5:2

e=2.4;
% for e=.1:.5:3

% gamma=.001;

zzz=lamda-epsilon-gamma;

Ro_num=(xi*e*v)*(alpha*c+b*(beta+lamda));
Ro_dem=a*(a+e)*(beta+lamda)*(lamda+v)*(alpha+r+gamma+lamda);

```

```

Ro=Ro_num/Ro_dem

% w_star=((beta+lmda))/(alpha+(gamma*Ro));

% sim('equation_9_10')
sim('equation_9_10_Nv_divide_Nh')
t=u(:,1);
u1=u(:,2);
w1=w(:,2);
R1=R(:,2);
x1=x(:,2);
z1=z(:,2);
Nh1=Nh(:,2);
Nv1=Nv(:,2);

figure(1)
plot(t,u1,'r')
hold on
plot(t,w1,'b')
plot(t,R1,'c')
plot(t,Nh1,'g')

xlabel('Time')
ylabel('u,w,R,Nh')
title('Graph of u, w, R,Nh')
legend('u','w', 'R','Nh')

figure(2)
plot(t,x1,'g')
hold on
plot(t,z1,'b')
% plot(t,Nh1,'r')
plot(t,Nv1,'c')
xlabel('Time')
ylabel('z, x, Nv')
title('Graph of x, z, Nv')
legend('x','z', 'Nv')

```

APPENDIX C
SIMULINK OF KERMACK AND MCKENDRICK SIR MODEL

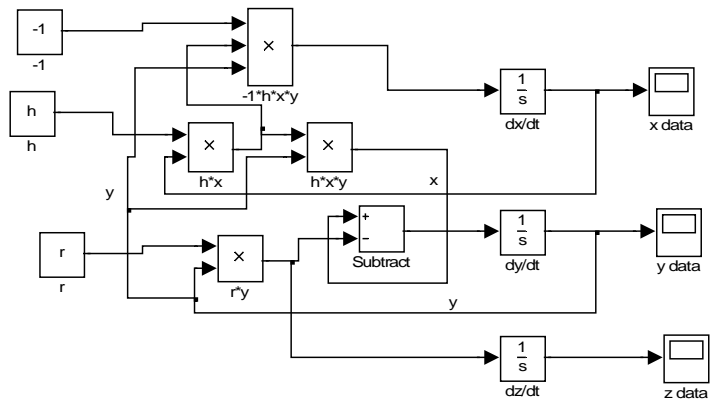

Figure 15: Simulink model of Kermack and McKendrick SIR Equation (1.3)

APPENDIX D
MATLAB CODE OF KERMACK AND MCKENDRICK SIR MODEL

```

clc
clear all
close all
x_initial=254;
y_initial=7;
% r=2.73;
for r=.1:.5:3
h=.0178;

sim('kermach_mckendrick_SIR')

t=x(:,1);
x1=x(:,2);
y1=y(:,2);
z1=z(:,2);
figure (1)
hold on
plot(x1,y1)
% axis([0 250 0 35])
xlabel('x(t)')
ylabel('y(t)')
legend('h increasing from top to bottom')

figure (2)
hold on
plot(t,x1)
xlabel('Time')
ylabel('x(t)')
legend('h decreasing from top to bottom')

figure(3)
hold on
plot(t,y1)
xlabel('Time')
ylabel('y(t)')
legend('h decreasing from top to bottom')

figure(4)
hold on
plot(x1,z1)
% axis([0 250 0 35])
xlabel('x(t)')
ylabel('z(t)')
legend('h increasing from top to bottom')

figure(5)
hold on
plot(z1,y1)
% axis([0 250 0 35])
xlabel('z(t)')
ylabel('y(t)')
legend('h increasing from top to bottom')
end

```

APPENDIX E
CLASSICAL SIR MATLAB CODE

```

clear all
close all
clc
for h=.1:.1:.9
% h=.5;
r=.5;
sim('SIR')
t=x(:,1);
x1=x(:,2);
y1=y(:,2);
z1=z(:,2);

figure(1)
plot(t,x1)
axis([0 50 0 1])
xlabel('Time')
ylabel('x values')
title('Values of x vs time as h varies')
legend('h decreasing from .9 to .1 left to right')
hold on

figure(2)
plot(t,y1)
axis ([0 50 0 .5])
xlabel('Time')
ylabel('y values')
title('Values of y vs time as h varies')
legend('h increasing from .1 to .9 bottom to top')
hold on

figure(3)
plot(t,z1)
axis([0 50 0 1])
xlabel('Time')
ylabel('z values')
title('Values of z vs time as h varies')
legend('h decreasing from .9 to .1 left to right','Location','south')
hold on

figure(4)
plot (x1,y1)
axis([0 1 0 .5])
xlabel('x values')
ylabel('y values')
title('Values of x vs y as h varies')
legend('h increasing from .1 to .9 bottom to top')
hold on

figure(5)
plot(x1,z1)
axis([0 1 0 1])
xlabel('x values')
ylabel('z values')
title('Values of x vs z as h varies')
legend('h decreasing from .9 to .1 left to right')
hold on

```

```
figure(6)
plot(y1,z1)
axis ([0 .5 0 1])
xlabel('y values')
ylabel('z values')
title('Values of y vs z as h varies')
legend('h increasing from .1 to .9 left to right')
hold on

end
```

APPENDIX F
CLASSICAL SIR SIMULINK

APPENDIX G
PREVENTION ON MALARIA

There is no vaccine available today to prevent malaria, therefore the best way to prevent catching malaria is by taking proscribed anti-malaria drugs when in areas that have malaria. Also all people in malaria ridden areas should protect themselves by using anti-mosquito measures. Avoid being out at night because that is when the *Anopheles* mosquito is most actively feeding. When you are outside wear long sleeved shirts and pants and treat your clothing with permethrin. Use an insect repellent that contains 35% DEET (N,N-diethylmethyln-toluamide). You should make sure that the room that you are staying in has screens and if possible spray with an insecticide before you sleep. If the room you are sleeping in is not air conditioned or screened sleep under a bednet that has been treated with permethrin.

The anti-malaria drugs, atovaquone/proguanil, doxycycline, mefloquine, primaquine [39], should be taken as proscribed by your doctor and the full dosage should be taken. Normally the drug treatment is started before you leave on your trip and the dosage is continued for several days after you return from your trip. If you were bitten by a mosquito carrying malaria during your trip the drugs will need several days to insure that all of the parasites injected by the mosquito are killed. Also remember that there are drug resistant strains of malaria so if you become sick after your trip seek medical help as soon as possible. Tell the doctor that you have been exposed to malaria and ask for a malaria blood test, because a blood test is the only positive means of diagnosis of malaria.

Another avenue that is being investigated as means of prevention of malaria is genetic manipulation of the mosquito. Biotechnologists have plans to introduce a gene into *Anopheles* that will confer resistance to the malaria parasite, *Plasmodium falciparum* [40]. After the researchers started an investigation into this line of research, it was found that nature might have already beaten man to the punch. *Anopheles gambiae* were collected from huts in Mali then their

offspring were allowed to feed on blood infected with *Plasmodium*, of the 101 different pedigrees 22 showed no trace of *Plasmodium* upon dissection. So another possible means of suppressing the spread of malaria is breeding massive amounts of the 22 pedigrees and releasing them in malaria prone areas and by their numbers suppress the *Anopheles* that carry *Plasmodium*.

Yet another new area of investigation for controlling the spread of malaria has been found by Simon Blanford. Mr. Blanford has found that mosquitoes infected by *Plasmodium* and then exposed to a new strain of fungi have a >90% mortality rate.[41] The rates of mortality peak around the time of sporozoite maturation, and infected mosquitoes showed reduced need to feed on blood. With mortality rates this high this fungus could be used in conjunction with chemical insecticides or as a replacement for those insecticides. Especially in areas where insecticides have lost much of their killing power due to high resistance on the part of the mosquitoes.

LIST OF REFERENCES

- [1] The Mathematical Theory of Infectious Diseases and its Applications, Norman T.J. Bailey, M.A., D. Sc. Hafner Press, New York, 1975.
- [2]The Wellcome Trust, retrieved October 10, 2004,
<http://www.wellcome.ac.uk/en/malaria/TheParasite/Pfviru.html>
- [3]The Wellcome Trust, retrieved October 10, 2004,
<http://www.wellcome.ac.uk/en/malaria/TheParasite/Pfviru.html>.
- [4]Rodin, E. Y., Murthy, D. N. P. and Page, N. W.: Mathematical Modelling: A Tool for Problem Solving in Engineering, Physical, Biological and Social Sciences, Pergamon Press, 1989.
- [5]Rodin, E. Y., Murthy, D. N. P. and Page, N. W.: Mathematical Modelling: A Tool for Problem Solving in Engineering, Physical, Biological and Social Sciences, Pergamon Press, 1989.
- [6]The Wellcome Trust, retrieved October 10, 2004,
<http://www.wellcome.ac.uk/en/malaria/TheParasite/Pfviru.html>.
- [7]Rodin, E. Y., Murthy, D. N. P. and Page, N. W.: Mathematical Modelling: A Tool for Problem Solving in Engineering, Physical, Biological and Social Sciences, Pergamon Press, 1989.
- [8]Malaria, Center for Disease Control and Prevention, retrieved June 24, 2006,
<http://www.cdc.gov/malaria/impact/index.htm>.
- [9]National Center for Infectious Diseases, Division of Parasitic Diseases, Center for Disease Control and Prevention, retrieved June 24, 2006, <http://www.cdc.gov/Malaria/biology/index.htm>.
- [10]The Mathematical Theory of Infectious Diseases and its Applications, Norman T.J. Bailey, M.A., D. Sc. Hafner Press, New York, 1975.
- [11]Malaria, Directors of Health Promotion and Education, retrieved June 22, 2006,
<http://www.dhpe.org/infect/Malaria.html>.
- [12]Department of Health and Human Services, Center for Disease Control and Prevention, Eradication of Malaria in the United States, retrieved June 21, 2006,
http://www.cdc.gov/malaria/history/eradication_us.html.
- [13]Pan American Health Organization. Report for registration of Malaria eradication for United States of America. Washington, DC: Pan American Health Organization; 1969.

- [14]Skarbinski, Jacek, Eliades, M. James, Center for Disease Control and Prevention, Malaria Surveillance – United States, May 26, 2006, MMWR, 2006; 55(No. SS-4):23-37.
- [15]Ngwa GA, Shu WS, A Mathematical Model for Endemic Malaria with Variable Human and Mosquito Populations, United Nations Educational Scientific and Cultural Organization and International Atomic Energy Agency, The Abdus Salam International Centre for Theoretical Physics, Miramare-Trieste, October 1999, retrieved June 26, 2006, http://www.ictp.trieste.it/~pub_off.
- [16]Rodin, E. Y., Murthy, D. N. P. and Page, N. W.: Mathematical Modeling: A Tool for Problem Solving in Engineering, Physical, Biological and Social Sciences, Pergamon Press, 1989 p3.
- [17]Smith, David L., McKenzie, F. Ellis, “Statics and dynamics of malaria infection in Anopheles mosquitoes”, Malaria Journal 3:13(2004). doi:10.1186/1475-2875-3-13.
- [18]Shonkwiler, R., Aneke, S.J., Some Mathematical Models For Malaria, School of Mathematics, Georgia Institute of Technology, Atlanta, Ga, retrieved October 10, 2004, <http://www.math.gatech.edu/~shenk/malaria.pdf>.
- [19]Brauer, Fred, and Castillo-Chavez, Carlos: Mathematical Models in Population Biology and Epidemiology. New York: Springer-Verlag New York Inc., 2001, page 282.
- [20]Brauer, Fred, and Castillo-Chavez, Carlos: Mathematical Models in Population Biology and Epidemiology. New York: Springer-Verlag New York Inc., 2001, page 285.
- [21]Shonkwiler, R., Aneke, S.J., Some Mathematical Models For Malaria, School of Mathematics, Georgia Institute of Technology, Atlanta, Ga, retrieved October 10, 2004, <http://www.math.gatech.edu/~shenk/malaria.pdf>.
- [22]The Wellcome Trust, retrieved October 10, 2004, <http://www.wellcome.ac.uk/en/malaria/TheMosquito/mrross1.html>.
- [23]Ross, R.: An application of the theory of probabilities to the study of *priori* pathometry, *Proc. Roy. Soc.*, A. 92 (1916), 204-230.
- [24]The Mathematical Theory of Infectious Diseases and its Applications, Norman T.J. Bailey, M.A., D. Sc. Hafner Press, New York, 1975.
- [25]Shonkwiler, R., Aneke, S.J., Some Mathematical Models For Malaria, School of Mathematics, Georgia Institute of Technology, Atlanta, Ga, retrieved October 10, 2004, <http://www.math.gatech.edu/~shenk/malaria.pdf>.
- [26]Shonkwiler, R., Aneke, S.J., Some Mathematical Models For Malaria, School of Mathematics, Georgia Institute of Technology, Atlanta, Ga., retrieved October 10, 2004, <http://www.math.gatech.edu/~shenk/malaria.pdf>.

- [27]Shonkwiler, R., Aneke, S.J., Some Mathematical Models For Malaria, School of Mathematics, Georgia Institute of Technology, Atlanta, Ga, retrieved October 10, 2004, <http://www.math.gatech.edu/~shenk/malaria.pdf>.
- [28]Lawot, Niwas, Mathematical Modeling of Smallpox with Optimal Intervention Policy, unpublished Masters Thesis, University of Central Florida, Orlando, Fl, summer 2006.
- [29]Ngwa, GA, Shu WS, A Mathematical Model for Endemic Malaria with Variable Human and Mosquito Populations, United Nations Educational Scientific and Cultural Organization and International Atomic Energy Agency, The Abdus Salam International Centre for Theoretical Physics, Miramare-Trieste, October 1999 retrieved June 26, 2006, http://www.ictp.trieste.it/~pub_off.
- [30]Ngwa, G.A., The Dynamics of Endemic Malaria in Populations of Varying Size, United Nations Educational Scientific and Cultural Organization and International Atomic Energy Agency and The Abdus Salam International Centre for Theoretical Physics, retrieved June 26, 2006, http://www.ictp.trieste.it/~pub_off.
- [31]Smith, David L., McKenzie, F. Ellis, “Statics and dynamics of malaria infection in Anopheles mosquitoes”, *Malaria Journal* 3:13(2004). doi:10.1186/1475-2875-3-13.
- [32] Ngwa, G.A., The Dynamics of Endemic Malaria in Populations of Varying Size, United Nations Educational Scientific and Cultural Organization and International Atomic Energy Agency and The Abdus Salam International Centre for Theoretical Physics, retrieved June 26, 2006, http://www.ictp.trieste.it/~pub_off.
- [33] Ngwa, G.A., The Dynamics of Endemic Malaria in Populations of Varying Size, United Nations Educational Scientific and Cultural Organization and International Atomic Energy Agency and The Abdus Salam International Centre for Theoretical Physics, retrieved June 26, 2006, http://www.ictp.trieste.it/~pub_off.
- [34] Ngwa, G.A., The Dynamics of Endemic Malaria in Populations of Varying Size, United Nations Educational Scientific and Cultural Organization and International Atomic Energy Agency and The Abdus Salam International Centre for Theoretical Physics, retrieved June 26, 2006, http://www.ictp.trieste.it/~pub_off.
- [35] Ngwa, G.A., The Dynamics of Endemic Malaria in Populations of Varying Size, United Nations Educational Scientific and Cultural Organization and International Atomic Energy Agency and The Abdus Salam International Centre for Theoretical Physics, retrieved June 26, 2006, http://www.ictp.trieste.it/~pub_off.
- [36]Routh Hurwitz method, retrieved Nov 01, 2006, <http://www.chem.mtu.edu/~tbco/cm416/routh.html>.

[37] Ngwa, G.A., The Dynamics of Endemic Malaria in Populations of Varying Size, United Nations Educational Scientific and Cultural Organization and International Atomic Energy Agency and The Abdus Salam International Centre for Theoretical Physics, retrieved June 26, 2006, http://www.ictp.trieste.it/~pub_off.

[38] Grimshaw, R., Nonlinear Ordinary Differential Equations, CRC Press Inc., 2000 Corporate Blvd., NW, Boca Raton, Florida, 33431 p84.

[39] Department of Health and Human Services, Center for Disease Control and Prevention, Eradication of Malaria in the United States, retrieved August 26, 2006, <http://www.cdc.gov/travel/malariadrugs.htm>.

[40] Michelle M. Riehle, Kyriacos Markianos, Oumou Niaré, Jiannong Xu,¹ Jun Li, Abdoulaye M. Touré, Belco Podiougou, Frederick Oduol, Sory Diawara, Mouctar Diallo, Boubacar Coulibaly, Ahmed Ouatarra, Leonid Kruglyak, Sékou F. Traoré, Kenneth D. Vernick, Natural Malaria infection in *Anopheles gambiae* Is Regulated by a Single Genomic Control Region, Science Magazine, April 28, 2006, Vol. 312, no 5773, pp 577-579.

[41] Simon Blanford, Brian H. K. Chan, Nina Jenkins, Derek Sim, Ruth J. Turner, Andrew F. Read, Matt B. Thomas, Fungal Pathogen Reduces Potential for Malaria Transmission, Science Magazine, June 10, 2005, Vol 308. no. 5728, pp 1638-1641.