

ALL THE CONTRIBUTION OF PRACTICING SCHOOL COUNSELORS' SELF-
EFFICACY AND PROFESSIONAL QUALITY OF LIFE TO THEIR PROGRAMMATIC
SERVICE DELIVERY

by

PATRICK RYAN MULLEN

B.A. Florida International University, 2006

M.A., University of Central Florida, 2009

A dissertation submitted in partial fulfillment of the requirements
for the degree of Doctor of Philosophy
in the College of Education and Human Performance
at the University of Central Florida
Orlando, Florida

Spring Term
2014

Major Professor: Glenn W. Lambie

©2014 Patrick Ryan Mullen

This dissertation is dedicated to my family.
My family has supported and encouraged me throughout the process.
Without my family, this could not have been done.

ABSTRACT

The purpose of this investigation was to examine the directional relationship between practicing school counselors' level of professional quality of life and self-efficacy to their programmatic service delivery activities. This investigation tested the theoretical model that practicing school counselors' level of professional quality of life (as measured by the Professional Quality of Life Scale [ProQOLs; Stamm, 2010]) and their self-efficacy (as measured by the School Counselor Self-Efficacy Scale [SCSEs; Bodenhorn & Skaggs, 2005]) contributes to their service delivery activity (as measured by the School Counselor Activity Rating Scale [SCARS; Scarborough, 2005]).

Specifically, this study examined the hypothesized directional relationship that school counselors who have higher ProQOL scores (e.g., less burnout and compassion fatigue and higher compassion satisfaction) and higher self-efficacy scores (e.g., more confident about counseling skills) have increased levels of programmatic service delivery facilitation (e.g., they provide high levels of school counseling activities for students and stakeholders). In addition, this investigation examined the relationship between practicing school counselors' demographic factors and the constructs of professional quality of life, self-efficacy, and programmatic service delivery. Furthermore, the investigation examined the difference in response rate and school counselors' total mean score (as measured by the ProQOLs, SCSEs, and SCARS) based upon the: (a) sampling method (e.g., email web-based, paper-pencil mail-out survey, face-to-face survey administration), (b) token incentive type (e.g., monetary [\$1.00, \$2.00, or no incentive] or non-monetary [\$1.00 donation to the American Red Cross or no donation]), and (c) sampling population (e.g., ASCA dataset or Common Core Dataset)?

A review of the literature is presented, which provides conceptual theory and empirical research to support the constructs and their hypothesized relationship. A descriptive, correlational research design was employed to investigate the research hypothesis and exploratory research questions. The data was collected through diverse survey methodologies (e.g., email web-based, paper-pencil mail-out survey, face-to-face survey administration). The research hypothesis was tested through the utilization of structural equation modeling (SEM). In addition, multiple linear regression, Spearman rho correlation, Mann-Whitney U tests, Kruskal-Wallis H tests, and Chi Square tests of independence were used to analyze the data for the exploratory questions. The results of the investigation are presented and compared to current literature and prior research. Additionally, the limitations of the study are discussed and recommendations for future research are presented. Last, implications from this investigation are discussed in regards to practicing school counselors, school counselor educators, and school counseling researchers.

The sample size for this investigation was 690 with 577 used for the data analysis after data cleaning. The results of the SEM analyses identified that practicing school counselors' professional quality of life contributed to their programmatic service delivery (1.21% of the variance explained). In addition, the results identified that practicing school counselors' self-efficacy contributed to their programmatic service delivery (34.81% of the variance explained). Furthermore, the analysis indicated that the covariance between professional quality of life and self-efficacy accounted for 26% of the shared variance between these two constructs of interest.

Implications of the findings from the study include (a) school counselors' self-efficacy contributes to their programmatic service delivery (large effect size), (b) school counselors' professional quality of life and self-efficacy contribute to one another (medium to large effect

size), and (c) school counselors' professional quality of life contributes to their service delivery (small effect size). Additionally, this study provides implications in regards to: (a) the psychometric properties of the ProQOLs, SCSEs, and SCARS with a national sample of practicing school counselors and (b) research methodology related to differences in school counselors' response rates and total mean score on the ProQOLs, SCSEs, and SCARS based upon the sampling method, incentive type, and sampling population.

ACKNOWLEDGMENTS

First and foremost, I acknowledge the patience, understanding, and love from my wife Laura. Her support and flexibility throughout this endeavor has made this dissertation possible. This was our dissertation because Laura has made just as much of a sacrifice as I have to complete this venture. Furthermore, I thank Ryan and our future children. If it were not for you, I would have not had the motivation or the desire to take on this challenge. To my parents, you have instilled the character and work ethic that allows me to accomplish anything. From as far back as elementary school, you have always been there to support, challenge, and guide me on this journey. To TJ, witnessing you take on the challenge of a Ph.D. provided me the confidence that I can do it too. You have always been there for help, thank you. To everyone else, thank you for asking questions and being a part of this journey. I am blessed to have an amazing family around me.

I must give thanks to Dr. Glenn W. Lambie. Dr. Lambie has spent just as much time as I have working on this dissertation. If not for you, I would not be the educator and researcher I aim to be. Thank you for all the support and opportunities you have provided throughout this time together. Thank you Dr. Mike Robinson, Dr. Stacy Van Horn, and Dr. Abigail Conley. You all have provided mentorship and guidance throughout this time. I am blessed to have gotten the opportunity to work with you through this committee and dissertation. Dr. Robinson, you have always been open to talking and challenging me. You have had a lasting impact on my identity as a counselor educator. Dr. Van Horn, since I was a master's student in your career class, you have been teaching me about school counseling, counselor education, and the balance of everything. You have been a positive support and mentor throughout my time at UCF. Dr. Conley, you have and will continue to challenge me to be a better researcher. Your knowledge

and experiences inspire me to never set limits. Again, to Drs. Lambie, Robinson, Van Horn, and Conley, I am grateful for your service on my committee and I hope to make your mentorship and effort worthwhile in my career.

To Dr. W. Bryce Hagedorn, if not for you and your positive view of my potential, I would never have been at UCF. You opened the door for many amazing possibilities. You pushed me into the fire and mentored me after the storms. I am the person, counselor, and educator as a result of your mentorship and teachings. No matter where I go, I will always carry on the things you taught me.

To my friends Catherine Griffith, Kristopher Hall, Melissa Zeligman, Diandra Prescod, Jennifer Green, Renee Sherrell, and Daniel Gutierrez, you made me laugh, you made me cry, and you helped me get through the program. I appreciate the much-needed laughs and encouragement. I am excited to see the wonderful things we will all do as we venture into this field. To Daniel, I would have never considered starting this program if not for knowing you would be here too. Whether to car rides to campus, or the two-hour coffee breaks, I always had someone of whom I could talk. Your friendship is much appreciated and valued. “I’ve learned that people will forget what you said, people will forget what you did, but people will never forget how you made them feel” - Maya Angelou.

To Jesse Fox, Dodie Limberg, Kristina DePue, and the other Sunrise Sojourners, thank you for laying the path and making the road smooth. Jesse, I am blessed to have gotten to know and work with you. You have been a good friend and teacher throughout the program. Dodie, your caring sense and investment in others shine true. Thanks for the many conversations and guidance. Kristina, you have provided much guidance and been a good friend. To Ashley, thanks

for making me think of the positive side of things. To the rest of the doc students I have worked with, you have made the ride bumpy but fun and memorable.

TABLE OF CONTENTS

LIST OF FIGURES	XX
LIST OF TABLES	XXII
CHAPTER ONE: INTRODUCTION.....	1
Statement of the Problem.....	5
Significance of the Study	8
Theoretical Framework.....	10
Social Cognitive Theory	10
Professional Quality of Life.....	11
Programmatic Service Delivery	13
Survey Research Methodology	16
Operational Definitions.....	17
ASCA (2012) National Model	17
Burnout	18
Compassion Fatigue.....	18
Compassion Satisfaction.....	18
Comprehensive School Counseling Program	18
Item Nonresponse	18
Nonprobability Sampling.....	18
Probability Sampling	19
School Counselor	19

Secondary Traumatic Stress.....	19
Self-Efficacy	19
Service Delivery.....	19
Survey Research.....	19
Token Incentive	20
Unit Nonresponse.....	20
Research Hypothesis and Exploratory Research Questions	20
Primary Research Question.....	20
Research Hypothesis.....	20
Exploratory Research Questions.....	24
Research Design	25
Research Method	26
Data Collection Procedures	29
Instrumentation	33
General Demographics Questionnaire	33
Professional Quality of Life Scale	34
School Counselor Self-Efficacy Scale	36
School Counselor Activity Rating Scale.....	39
Data Analysis.....	42
Statistical Method used to examine the Research Hypothesis.....	43

Statistical Methods used to examine Exploratory Research Questions One, Two, and Three	44
Statistical Methods used to examine Exploratory Research Questions Four and Five	44
Ethical Considerations	45
Potential Limitations of the Study	45
Chapter One Summary	46
CHAPTER TWO: REVIEW OF THE LITERATURE	47
Introduction	47
Social Cognitive Theory	47
Self-Efficacy	49
School Counselor Self-Efficacy	52
Empirical Research on Self-Efficacy	53
Professional Quality of Life	59
Quality of Life	59
Professional Quality of Life	61
Compassion Satisfaction	62
Compassion Fatigue	64
Empirical Research on Professional Quality of Life Factors	66
School Counselor Service Delivery	72
History, Growth, and Development of the School Counseling Profession	72
Empirical Research on Programmatic Service Delivery	76
School Counselors' Self-Efficacy, Professional Quality of Life, and Service Delivery	82

Survey Research Methodology	85
Nonresponse in Survey Research.....	90
Token incentive.....	92
Empirical Research on Survey Methodology	93
Chapter Two Summary.....	96
CHAPTER THREE: METHODS.....	97
Population and Sampling Procedures	98
Sample Size Determination.....	98
Population	100
Data Collection	102
Instrumentation	107
General Demographics Questionnaire	107
Professional Quality of Life Scale (ProQOLs).....	108
School Counselor Self-Efficacy Scale (SCSEs)	110
School Counselor Activity Rating Scale (SCARS)	113
Research Design	117
Research Hypothesis and Exploratory Questions.....	122
Primary Research Question.....	122
Research Hypothesis.....	122
Exploratory Research Questions.....	126
Data Analysis	127

Statistical Power.....	128
Research Hypothesis.....	129
Further Breakdown of Steps in SEM.....	133
Statistical Methods used to examine Exploratory Research Questions One, Two, and Three	134
Statistical Methods used to examine Exploratory Research Questions Four and Five.....	135
Dependent and Independent Variables.....	135
Dependent/Endogenous Variable.....	135
Independent/Exogenous Variables.....	136
Ethical Considerations.....	137
Study Limitations.....	137
Chapter Three Summary.....	138
CHAPTER FOUR: DATA RESULTS.....	139
Sampling and Data Collection Procedures.....	140
Descriptive Data Results.....	143
Response Rate.....	143
Participant Characteristics.....	145
School Characteristics.....	149
Likert Demographic Items.....	152
Professional Quality of Life.....	157
School Counselor Self-Efficacy.....	159

Programmatic Service Delivery.....	160
Data Analysis for the Research Hypothesis and Exploratory Research Questions	161
Data Screening and Statistical Assumptions for SEM.....	162
Adjusted Descriptive Statistics for Data Analysis	166
Estimation Technique	168
Parceling of Ordinal Data	169
Research Hypothesis and Exploratory Questions.....	170
Primary Research Question.....	171
Research Hypothesis.....	172
Model Specification and Identification.....	172
Measurement Model Modification for this Data	173
Factor Analysis for Professional Quality of Life	174
Factor Analysis for School Counselor Self-Efficacy.....	178
Factor Analysis for School Counselor Programmatic Service Delivery	182
Complete Measurement Model.....	187
Complete Parceled Measurement Model	188
Structural Model	190
Follow Up Analyses.....	194
Complete Second-Order Measurement Model	195
Second-Order Structural Model.....	196
Standard Multiple Regression.....	201

Exploratory Research Questions.....	202
Exploratory Research Question One.....	202
Exploratory Research Question Two.....	209
Exploratory Research Question Three.....	215
Exploratory Research Question Four.....	221
Exploratory Research Question Five.....	228
Chapter Four Summary.....	231
CHAPTER FIVE: DISCUSSION.....	232
Introduction and Statement of the Problem.....	232
Review of the Methodology.....	233
Population and Sample.....	234
Data Collection.....	235
Instrumentation.....	236
Data Analysis.....	237
Data Screening and Statistical Assumptions for SEM.....	238
Summary of the Results.....	238
Descriptive Data Results.....	239
Participant Response Rate.....	239
Participant Characteristics.....	240
School Characteristics.....	242
Likert Demographic Items.....	245

Instrumentation and Measurement Model	250
School Counselor Professional Quality of Life	250
School Counselor Self-Efficacy.....	253
School Counselor Programmatic Service Delivery	256
Complete Measurement Model.....	259
Parceled Measurement Model.....	260
Primary Research Question Results.....	260
Primary Research Question.....	260
Research Hypothesis.....	261
Post-Hoc Analysis.....	263
Follow-Up Analysis	267
Discussion of the Results for the Hypothesis	267
Summary of the Results for the Hypothesis	270
Exploratory Research Questions.....	271
Study Limitations.....	292
Research Design Limitations	292
Sampling Limitations.....	293
Instrumentation Limitations.....	294
Recommendations for Future Research.....	295
Research on Factors that Contribute to Programmatic Service Delivery	295
Research on Sampling Methodology, Incentive Type, and Samples Population	296

Implications	297
Implications for Practicing School Counselors.....	297
Implications for School Counselor Education	300
Implications for School Counseling Researchers	301
Implications for the Instrumentation Used in this Investigation.....	303
Chapter Five Summary	304
APPENDIX A: UNIVERSITY OF CENTRAL FLORIDA INSTITUTIONAL REVIEW	
BOARD APPROVAL FORM	305
APPENDIX B: EXPLANATION OF RESEARCH.....	307
APPENDIX C: GENERAL DEMOGRAPHICS FORM	309
APPENDIX D: SCHOOL COUNSELOR SELF-EFFICACY SCALE	313
APPENDIX E: SCHOOL COUNSELOR ACTIVITY RATINGS SCALE	316
APPENDIX F: PROFESSIONAL QUALITY OF LIFE SCALE	319
APPENDIX G: RECRUITMENT EMAIL FOR ASCA ONLINE MEMBERSHIP	
DIRECTORY – NO INCENTIVE.....	321
APPENDIX H: REMINDER EMAIL FOR ASCA ONLINE MEMBERSHIP DIRECTORY –	
NO INCENTIVE	324
APPENDIX I: FINAL REMINDER EMAIL FOR ASCA ONLINE MEMBERSHIP	
DIRECTORY – NO INCENTIVE.....	326
APPENDIX J: RECRUITMENT EMAIL FOR ASCA ONLINE MEMBERSHIP DIRECTORY	
– WITH INCENTIVE.....	328
APPENDIX K: REMINDER EMAIL FOR ASCA ONLINE MEMBERSHIP DIRECTORY –	
WITH INCENTIVE.....	331

APPENDIX L: FINAL REMINDER EMAIL FOR ASCA ONLINE MEMBERSHIP	
DIRECTORY – WITH INCENTIVE	333
APPENDIX M: RECRUITMENT LETTER FOR PAPER/MAIL SURVEY – NO INCENTIVE	
.....	335
APPENDIX N: RECRUITMENT LETTER FOR PAPER/MAIL SURVEY – WITH	
INCENTIVE	337
APPENDIX O: POSTCARD REMINDER FOR PAPER/MAIL SURVEY	339
APPENDIX P: REPLACEMENT PACKET REMINDER LETTER FOR PAPER/MAIL	
SURVEY.....	341
APPENDIX Q: FINAL REMINDER LETTER FOR PAPER/MAIL SURVEY	343
APPENDIX R: WEBSITE PERMISSION TO USE THE PROQOLS	345
APPENDIX S: EMAIL PERMISSION TO USE THE SCSES	347
APPENDIX T: EMAIL PERMISSION TO USE AND ADJUST THE SCARS	349
APPENDIX S: CONFIRMATION OF DONATION TO THE AMERICAN RED CROSS	351
REFERENCES	353

LIST OF FIGURES

Figure 1: Measurement Model for the SCSEs (Bodenhorn & Skaggs, 2005).....	21
Figure 2: Measurement Model for the ProQols (Stamm, 2010).....	22
Figure 3: Measurement Model for the SCARS (Scarborough, 2005)	23
Figure 4: Path Diagram of the Structural Model to be tested	24
Figure 5: Diagram of Professional Quality of Life.....	62
Figure 6: Measurement Model for the SCSEs (Bodenhorn & Skaggs, 2005).....	123
Figure 7: Measurement Model for the ProQOLs (Stamm, 2010).....	124
Figure 8: Measurement Model for the SCARS (Scarborough, 2005)	125
Figure 9: Path Diagram of the Structural Model to be Tested.....	126
Figure 10: Path Diagram of the Structural Model to be tested	172
Figure 11: Scree Plot for the ProQOLs.....	176
Figure 12: Modified Measurement Model of the ProQOLs	178
Figure 13: Scree plot for the SCSEs	181
Figure 14: Modified Measurement Model for the SCSEs	182
Figure 15: Scree plot for the SCARS.....	185
Figure 16:Modified Measurement Model for the SCARS.....	187
Figure 17: Modified Measurement Model for the SCARS.....	188
Figure 18: Complete Parceled Measurement Model	189
Figure 19: Modified Structural Model.....	191
Figure 20: Modified Respecified Structural Model	193
Figure 21: Complete Second-Order Measurement Model.....	196
Figure 22:Modified Second-Order Structural Model	200

Figure 23: Complete Measurement Model	259
Figure 24: Parceled Measurement Model	260
Figure 25: Path Diagram of the Structural Model to be tested	261
Figure 26: Modified Structural Model	263
Figure 27: Complete Second-Order Measurement Model	264
Figure 28: Modified Second-Order Structural Model	266

LIST OF TABLES

Table 1 Correlations between SCARS and SCSES subscales 58

Table 2 Sampling Characteristics 107

Table 3 Description of Fit Indices 134

Table 4 Sampling and Data Collection Methodology..... 145

Table 5 Categorical Demographic Variables – Participant Characteristics..... 148

Table 6 Categorical Demographic Variables – School Characteristics 151

Table 7 Likert Demographic Item 1 – Principal-Counselor Relationship 152

Table 8 Likert Demographic Item 2 – Principal-Counselor Relationship, Frequency 153

Table 9 Likert Demographic Item 3 – Principal-Counselor Relationship, Frequency 153

Table 10 Likert Demographic Item 4 – Work Satisfaction, Frequency..... 153

Table 11 Likert Demographic Item 5 – Work Satisfaction, Frequency..... 154

Table 12 Likert Demographic Item 6 – Work Satisfaction, Frequency..... 154

Table 13 Likert Demographic Item 7 – Work Stress, Frequency 155

Table 14 Likert Demographic Item 8 – Work Stress, Frequency..... 155

Table 15 Likert Demographic Item 9 – Work Stress, Frequency..... 155

Table 16 Likert Demographic Item 10 – Perceived Job Control, Frequency 156

Table 17 Likert Demographic Item 11 – Perceived Job Control, Frequency 156

Table 18 Likert Demographic Item 12 – Perceived Job Control, Frequency 157

Table 19 ProQOLs Central Tendencies 158

Table 20 SCSE Central Tendencies 160

Table 21 SCARS Central Tendencies..... 161

Table 22 Adjusted ProQOLs Central Tendencies..... 166

Table 23 Adjusted SCSE Central Tendencies	167
Table 24 Adjusted SCARS Central Tendencies	168
Table 25 Description of Fit Indices	171
Table 26 Exploratory Factor Analysis of the ProQOLs.....	176
Table 27 Model fit Indices of the ProQOLs	177
Table 28 Exploratory Factor Analysis of the SCSEs.....	180
Table 29 Model fit Indices of the SCSEs.....	182
Table 30 Exploratory Factor Analysis of the SCARS	185
Table 31 Model fit Indices of the SCARS	186
Table 32 Model fit Indices of the Full Measurement Model	188
Table 33 Model fit Indices of the Full Measurement Model	189
Table 34 Model fit Indices of all Parceled Structural Models	191
Table 35 Model fit Indices of all Parceled Structural Models	193
Table 36 Model fit Indices of the Full Measurement Model	195
Table 37 Model fit Indices of all Structural Models.....	198
Table 38 Pearson-Moment Correlations	202
Table 39 Spearman Rank Order Correlations Between Demographics Factors and Self-Efficacy, Participant Characteristics	205
Table 40 Spearman Rank Order Correlations Between Demographics Factors and Self-Efficacy, Setting Characteristics	207
Table 41 Spearman Rank Order Correlations Between Demographics Factors and Self-Efficacy, Other Demographic Information.....	209

Table 42 Spearman Rank Order Correlations between Demographics Factors and Programmatic Service Delivery, Participant Characteristics	211
Table 43 Spearman Rank Order Correlations Between Demographics Factors and Programmatic Service Delivery, Setting Characteristics	213
Table 44 Spearman Rank Order Correlations between Other Demographics Factors and Programmatic Service Delivery, Setting Characteristics	215
Table 45 Spearman Rank Order Correlations between Demographics Factors and Professional Quality of Life, Participant Characteristics	218
Table 46 Spearman Rank Order Correlations between Demographics Factors and Professional Quality of Life, Setting Characteristics	219
Table 47 Spearman Rank Order Correlations between Other Demographics Factors and Professional Quality of Life, Setting Characteristics.....	220
Table 48 Unit Nonresponse Rates.....	231
Table 49 Sampling and Data Collection Methodology.....	239
Table 50 Spearman Rank Order Correlations Between Demographics Factors and Self-Efficacy, Participant Characteristics	272
Table 51 Spearman Rank Order Correlations between Demographics Factors and Self-Efficacy, Setting Characteristics	274
Table 52 Spearman Rank Order Correlations between Demographics Factors and Self-Efficacy, Other Demographic Information.....	275
Table 53 Spearman Rank Order Correlations between Demographics Factors and Programmatic Service Delivery, Participant Characteristics	276

Table 54 Spearman Rank Order Correlations between Demographics Factors and Programmatic Service Delivery, Setting Characteristics	276
Table 55 Spearman Rank Order Correlations between Demographics Factors and Programmatic Service Delivery, Setting Characteristics	278
Table 56 Spearman Rank Order Correlations between Demographics Factors and Professional Quality of Life, Participant Characteristics	280
Table 57 Spearman Rank Order Correlations between Demographics Factors and Professional Quality of Life, Setting Characteristics	280
Table 58 Spearman Rank Order Correlations between Demographics Factors and Professional Quality of Life, Setting Characteristics	281

CHAPTER ONE: INTRODUCTION

The purpose of this study was to investigate the contribution of practicing school counselors' self-efficacy and professional quality of life to their service delivery activities. The study tested the theoretical model that practicing school counselors' level of self-efficacy (as measured by the *School Counselor Self-Efficacy scale* [SCSEs; Bodenhorn & Skaggs, 2005]) and professional quality of life (as measured by the *Professional Quality of Life scale* [ProQOLs; Stamm, 2010]) contributes to their level of service delivery (as measured by the *School Counselor Activity Rating Scale* [SCARS; Scarborough, 2005]). Specifically, this study tested the hypothesized directional relationship that school counselors that report higher self-efficacy and positive professional quality of life scores (compassion satisfaction, compassion fatigue, and burnout) complete programmatic service delivery activities at a higher rate. Furthermore, the study examined the relationships between demographic characteristics and professional quality of life, school counselors' level of self-efficacy, and programmatic service delivery.

Another purpose of this study was to examine survey research methodology for collecting data from practicing school counselors. Specifically, the study examined the difference in respondent characteristics (e.g., demographic variables, average total scale score, and average subscale score) based upon the survey methodology employed (e.g., data collection type, incentive type, sampling method, and sampling population). In addition, the study examined the difference in respondent unit-response/non-response rate based upon the sampling methodology employed (e.g., data collection type, incentive type, sampling method, and sampling population).

The school counseling profession emerged out of the need to support students' personal/social, academic, and career development (Schmidt, 2008). From the earliest history of school counseling, the professional was tasked to provide a service that supports students'

abilities to enter the community prepared to contribute to the workforce in a satisfying way (Gysbers & Henderson, 2006). Over time, the political and cultural changes have impacted the role of school counselors by requiring they address unique student needs (e.g., truancy, bullying, and negative coping skills) that influence students' success in school (Coleman & Yeh, 2008). In addition, the implementation of school counseling services is effective at enhancing student achievement (Lapan, 2012; Lapan, Gysbers, & Sun, 1997; Whiston, Tai, Rahardja, & Eder, 2011), which necessitates research on factors that relate to the implementation of school counselor programmatic service delivery. Therefore, the development and enhancement of school counselor service delivery is a critical topic that warrants additional inquiry.

Programmatic service delivery is a primary component of a school counselors' job (American School Counselor Association [ASCA], 2010, 2012). School counseling professionals are expected to hold the competence and proficiency to delivery services that are ethical and efficient in supporting and reacting to students complex and diverse needs (American Counselor Association [ACA], 2005; ASCA, 2010, 2012). Competency involves the ongoing awareness in regards to new evidenced-based practices (ACA, 2005), which includes continuing education to enhance skills and abilities. Furthermore, school counselors strive to eliminate barriers that might hinder services to all students' achievement and development (ASCA, 2010, 2012). In other words, school counselors pursue strategies that optimize the services they provide in an effort to support the development and success of *all* students.

School counselor self-efficacy relates to counselors' programmatic service delivery (e.g., Bodenhorn, Wolfe, Airen, 2010; Owens, Bodenhorn, & Bryant, 2010; Sutton & Fall, 1995). Specifically, researchers have examined the relationship between school counselor self-efficacy and the following variables: (a) school climate factors (Sutton & Fall, 1995), (b) school

counseling program choice/implementation (Bodenhorn et al., 2010), (c) use of the ASCA *National Model* (Clark, 2009), (d) attachment and service delivery (Ernst, 2012), and (e) work wellness and service delivery (Woods, 2009). However, no published studies were identified that examined the contribution of practicing school counselors' self-efficacy and professional quality of life to their service delivery.

The measure of professional quality of life (e.g., compassion fatigue, burnout, and compassion satisfaction) is limited in counseling literature (e.g., Lawson, 2007; Lawson & Meyers, 2011; Martin, 2012). Professional quality of life is researched in other helping professional fields (e.g., social work, trauma, medical fields; Craig & Sprang, 2009; Craig & Sprang, 2010; Sprang, Whitt-Woosley, & Clark, 2007). Likewise, professional quality of life is examined when researching individuals who have experienced stressful events (Stamm, 2010); including a broad range of helping professional fields such as: (a) social workers, (b) psychologist, (b) counselors, (c) teachers, (d) nurses, and (e) child protection workers.

Assessing professional quality of life appears to be an innovative approach for the counseling profession. The construct of burnout (which is a factor in professional quality of life) is often researched in school counseling literature but oftentimes produces non-normal distributed data (e.g., Lambie, 2007; Limberg, 2013) that make the results difficult to interpret. Additionally, many research studies examining counselor burnout uses the *Maslach Burnout Inventory* (MBI; Mashlack & Jackson, 1996), which has indicated that school counselors exhibit moderate to high emotional exhaustion and high personal accomplishment (Butler & Constantine, 2005; Lambie, 2007; Limberg, 2013). As such, researching professional quality of life may offer new information that the traditional measure of burnout (e.g., MBI) has *not* provided.

The research on professional quality of life in school counseling has focused on the comparison of school counselors' state of wellbeing; rather than on the impact of wellbeing on their job performance (e.g., Lawson, 2007; Lawson & Meyers, 2011). Additionally, published research on professional quality of life in counseling focuses on *all* counselors with school counseling being a part of the larger participant pool. Programmatic service delivery is researched in school counseling (e.g., Clemens, Milsom, & Cashwell, 2009; Shillingford & Lambie, 2009; Woods, 2009). In addition, programmatic service delivery was examined as a factor impacting school counselors' wellness (e.g., Woods, 2009) and as being impacted by other factors (e.g., principal-counselor relationships; Clemens et al., 2009). Moreover, multiple scales were developed to measure service delivery and/or program implementation (e.g., Clemens, Carey, & Harrington, 2010; Clemens et al., 2009; Scarborough, 2005). Researchers have investigated the relationship between school counselor self-efficacy and service delivery (e.g., Clark, 2006, Ernst, 2012); however, these studies contain methodological limitations (i.e., limited sampling technique) and look at unique constructs that may *not* examining the phenomenon at hand. No published studies were identified that examined how school counselors' self-efficacy and professional quality of life contribute to their service delivery.

The use of survey research in educational and social sciences is common practice (Converse, 1987; Fink, 2006; Hackett, 1981). Surveys allow researchers to explore the participants' status in relationship to constructs of interests and the relationships between a set of theorized constructs (Groves, Fowler, Couper, Lepkowski, Singer, & Tourangeau, 2004). There exist accepted methodology for survey research in educational and social science fields (e.g., *Tailored Design Method*; Dillman et al., 2009). However, it is meritorious to examine survey methodology with populations of interest (i.e., school counselors) through empirical inquiry

because it may support the validity the research methods for that population. Researchers have sought to examine survey data collection processes (e.g., Dykema, Stevenson, Klein, Kim, & Day, 2013; Greenlaw & Brown-Welty, 2008; Shih & Fan, 2008; Wolfe, Converse, & Oswald, 2008). However, there is limited research on survey methods in school counseling research. In a review of published literature in the journals of *Professional School Counseling*, *Journal of Counseling and Development*, and *Measurement and Evaluation in Counseling and Development* (using the ERIC database), there were *no* identified published articles in these journals that empirically examined surveying methodology with school counselors. A single article (Wolfe et al., 2009) examined unit and item nonresponse rates among school counselor respondents based upon sampling method (email or paper mail) but did *not* examine the data collection process involved in survey methodology. A rigors study of survey methodology is needed to support and guide the current practices research in the field of school counseling.

This study examined how practicing school counselors' self-efficacy and professional quality of life related to their programmatic service delivery. Additionally, the investigation examined the relationship between practicing school counselors' demographic factors, professional quality of life, self-efficacy, and programmatic service delivery. Furthermore, the study examined the use of survey research methodology for collecting data from practicing school counselors.

Statement of the Problem

Service delivery is a critical aspect of the school counselors' job (Erford, 2007). In addition, school counselors' service delivery supports student success (Lapan, 2012; Lapan et al., 1997; Sinke & MacDonald, 1998; Whiston et al., 2011). ASCA provides a comprehensive developmental school counseling program framework for school counselors and they

disseminate their recommendations through the *ASCA National Model* (ASCA, 2003, 2005, 2012). In addition, school counselors' have standards that support their competence in facilitating effective school counseling programs (Campbell & Dahir, 1997). Moreover, school counselor training programs emphasize the knowledge and skills to establish and facilitate comprehensive developmental school counseling programs by educating school counselors-in-training in regards to the *ASCA National Model* (2012) and the school counseling standards (e.g., Campbell & Dahir, 1997; ASCA, 2012; Council for Accreditation of Counseling and Related Educational Programs [CACREP], 2009).

School counselors have four foundational interventions that serve as the modality for service delivery, including: (a) counseling, (b) curriculum, (c) consultation, and (d) coordination (ASCA, 2012). School counselors employ these interventions to support and enhance students' personal/social, academic, and career development. Continued research on service delivery, and these four service delivery factors is warranted (Borders & Drury, 1992; Scarborough, 2005; Whiston & Sexton, 1998).

Self-efficacy is a cognitive process that influences individuals' thoughts and decision-making processes (Bandura, 1997). Additionally, school counselors' self-efficacy influences their service delivery and other aspects of their job (Bodenhorn & Skaggs, 2005; Bodenhorn et al., 2010; Owens et al., 2010; Sutton & Fall, 1995). Specifically, self-efficacy is positively correlated with service delivery with a medium effect size (Clark, 2006; Woods, 2009). Yet, the literature on school counselor self-efficacy and the relationship between service delivery and school counselors' self-efficacy is limitations, which warrants further investigation.

Limited research is published investigating the relationship between school counselor self-efficacy and professional quality of life. Professional quality of life is a newer construct

(Stamm, 2010), which is utilized in various helping professions to assess the welling being of practitioners (e.g., Craig & Sprang, 2009; Craig & Sprang, 2010; Sprang et al., 2007) and is becoming more prevalent in counseling literature (Lawson, 2007; Lawson & Meyers, 2011). However, professional quality of life application to school counseling literature is limited. As a result, this study sought to build upon the current research and advanced the scientific knowledge regarding school counseling best practices by investigating factors that contribute to school counselor service delivery. There is limited research on factors that influence school counselors' service delivery, including the examination of professional quality of life and self-efficacy's influence. In addition, school counselors have an ethical and professional expectation to provide effective school-based interventions to their stakeholders (ASCA, 2010). Therefore, this study contributes to the professional literature by examining the relationships of self-efficacy and professional quality of life to the reported behaviors of school counselors to support the programmatic services rendered by school counselor.

Examining research methodology can support the validity in which data is collected. There are inconsistent methods of survey data collection methods in school counseling research, including the use of face-to-face (e.g., Lambie, Ieva, Mullen, & Hayes, 2011), web based (e.g., Harris, 2013), and mail (e.g., Lambie, 2007) based methods of collection. In addition, sampling procedural vary, including convenience sampling (Lambie et al., 2011), sampling based on association to a professional organization at the state (e.g., Woods, 2009) and national (Bodenhorn et al., 2010), and cluster sampling based on multiple state (Clemens et al., 2009). However, no published research was identified that compares methods of sampling or data collection methods within school counseling, leaving researchers with limited knowledge about

effective methodologies in researching school counseling populations. Research on survey methodology in school counseling is needed to validate the methods researcher use.

Significance of the Study

The contribution of the study to the school counseling literature is significant. Specifically, the study sought to contribute: (a) a clearer understanding of factors that influence school counselors' service delivery; (b) a descriptive examination of school counselors' service activity, self-efficacy, and professional quality of life; (c) an increased understanding of the relationships between service delivery, self-efficacy, and professional quality of life; (d) an examination of the psychometric properties (e.g., Confirmatory Factor Analysis) of the data collection instruments (e.g., SCARS, Scarborough, 2005; SCSE, Bodenhorn & Skaggs, 2005; and ProQOL, Stamm, 2010); and (e) an investigation of different sampling and data collection methods to identify their efficacy. Moreover, this study addresses a gap in the literature by examining how interpersonal qualities of school counselors (e.g., self-efficacy and wellbeing) contribute to their delivery of services.

School counselors provide comprehensive services to a diverse body of students with the goal of supporting their personal/social, academic, and career development (ASCA, 2012). A primary goal for school counselors is to create equal opportunities for students to achieve success by removing barriers that hinder successful development, which may be achieved through systemic, holistic services that are rendered in a multitude of ways. To be effective, school counselors need internal (personal factors) and external (systemic) support that enables efficient services (Gysbers & Henderson, 2006; Schmidt, 2008; Skovholt & Trotter-Mathison, 2010). This study examined the aforementioned factors in the form of professional quality of life, self-

efficacy, and service delivery. Therefore, this investigation adds to the literature on constructs that contribute to school counselors facilitating comprehensive services to students.

Survey research is a common practice in social sciences (Dixon & Tucker, 2010; Hackett, 1981). Some research on survey methodology is available (e.g., Wolfe et al., 2009); however, research on survey methodology is sparse. Specifically, there is a limited research on survey methods for practicing school counselors. Researchers (e.g., Dillman et al., 2009) offer recommendations for best practices in conducting survey research and some research have identified the characteristics survey research (e.g., Wolfe, 2003; Wolfe et al., 2009; Wolfe, Converse, & Oswald, 2008). Yet, there is a need to further explore the effectiveness and efficient survey methodology for researching practicing school counselors exists.

In summary, research supports the potential contribution of self-efficacy and professional quality of life to school counselor service delivery; however, *no* current studies examine this relationship. Therefore, this study is meaningful because it addresses this gap in the research through the examination of the directional relationships between school counselors' self-efficacy, professional quality of life, and service delivery. The results may guide pedagogical interventions on systemic levels (e.g., district training, professional development, entry-level training) that support ongoing effective service delivery on behalf of school counselors. Furthermore, this study adds to the literature by investigating the difference in respondent characteristics and response rate based upon the employed sampling methodology. The findings in regards to survey methods help shape future survey research study's that examine the population of practicing school counselors by providing information on the difference in respondent characteristics and respondent response rate based upon survey methodology.

Theoretical Framework

Social Cognitive Theory

Social Cognitive Theory (SCT) was first developed through the works of Miller and Dollard (1941). Initially, SCT was titled *Social Learning Theory* (SLT), with a focus on the learning that takes place from social interactions. Rotter (1954, 1982) used SLT to explain aspects of the personality. Specifically, Rotter applied SLT to clinical practice in the book *Social Learning Theory and Clinical Psychology* (1954). Bandura and Walters (1963) expanded upon Miller and Dollard's (1941) SLT and emphasized that learning was a social process. Later, Bandura (1986) focused on expectancies and cognitive variables as a source of learning in SLT as compared to the theory's initial emphasis on drive reduction mechanisms (Rotter, 1982). Bandura (1986) moved from SLT to SCT as an attempt to emphasize the cognitive development that results from the social interactions.

SCT (Bandura, 1977b) is a theory that conceptualizes individuals' learning to be the product of cognitive development formed as a result of interactional processes that a learner experiences with their environment. SCT takes into consideration that a learner's cognitive processes are an active agent in reality formation that results from assimilation of information (Bandura, 1977b). According to SCT, learning occurs through the observation of others, personal experiences, and various forms of contact (Bandura, 1977b). Triadic reciprocal causation is a concept that represents the influence of personal factors, environment, and behavior on decision-making and learning processes (Bandura, 1986, 1989). The actions and decision an individual makes is a product of self-generated reasons that are persuaded by these interactions (Bandura, 1986). An additional mechanism of decision-making and action is self-efficacy.

Self-efficacy. Self-efficacy is the belief and/or confidence individuals' holds regarding a task or goal that they are attempting to complete (Bandura, 1977a, 1997). In other words, self-

efficacy is the confidence individuals have in their ability to complete a task. Self-efficacy is considered an appropriate assessment and evaluation tool in the counseling field (Daniels & Larson, 1998). As such, researchers have examined school counselor self-efficacy (e.g., Bodenhorn et al., 2010; Bodenhorn & Skaggs, 2005; Clark, 2006; Owens et al., 2010; Sutton & Fall, 1995). The study sought to examine school counselors' self-efficacy contributes to service delivery. It was anticipated that counselors' efficacy contributes to their engagement in service delivery activities (Bandura, 1997). Therefore, school counselors with higher levels of self-efficacy were predicted to score at higher levels of service delivery.

Professional Quality of Life

Quality of life has various definitions (Felece & Perry, 1995). Essentially, quality of life represents an overall perceived wellbeing of individuals with consideration to their physical, mental, social, spiritual, and cultural health (Felece & Perry, 1995; World Health Organization [WHO], 1998). Quality of life is broad and complex in that it attempts to organize a sense of an individuals' wellbeing from their diverse and complex self (World Health Organization, 1998). Nevertheless, quality of life provides both a descriptive and evaluative manner to researching peoples' wellbeing (Sirgy, Michalos, Ferriss, Easterlin, Pavot, & Patrick, 2006).

Professional quality of life represents an individual overall wellbeing; however, it focuses on their wellbeing in relation to their vocation (Stamm, 2010). Specifically, professional quality of life references how individuals' feel and react in relation to their role as a helper and their success in their job (Stamm, 2010). For this study, professional quality of life represents how participants feel regarding their work as a school counselor with students. Professional quality of life is a construct that consists of two contributing factors, including (a) compassion fatigue and (b) compassion satisfaction. The factor *compassion fatigue* can be further broken down into two

sub-factors of secondary traumatic stress and burnout. These two subfactors represent the negative (compassion fatigue) and positive (compassion satisfaction) emotional reactions to the work environment.

Compassion satisfaction. Research on counselors' wellbeing is prevalent in the literature; however, there is limited published research investigating how positive experiences impact counselors' work (Linley & Joseph, 2007). Compassion satisfaction represents the pleasure individuals' gets from doing their job as a helping professional (Stamm, 2010). Compassion satisfaction is the result of a satisfying working experience, which may include colleague support, the contribution to the work setting, and the contribution to society (Cicognani, Pietrantonio, Palestini, & Prati, 2009). Compassion satisfaction is an outcome of an individual's work. As such, it is logical to believe that those who gain higher levels of satisfaction from their work are more likely to engage in the activity that fostered the positive experience outcome.

Compassion fatigue. Compassion fatigues occurs as a result of exposure to job-related events that cause stress (Figley, 1995). Stamm (2010) identifies two specific components of compassion fatigue, secondary traumatic stress and burnout.

Secondary traumatic stress. Secondary traumatic stress is emotional duress that results from close contact with an individual who has experienced a trauma (Figley , 1983, 1995; Figley & Kleber, 1995; Stamm, 2010). Additionally, secondary traumatic stress is considered an occupational hazard of helping professionals (Bride, Hatcher, & Humble, 2009). Secondary traumatic stress has similar symptoms as Post Traumatic Stress Syndrome (PTSD; Jenkins & Baird, 2002). Figley (1995) renamed secondary traumatic stress to compassion fatigue to reduce the stigma associated with its name. Additionally, Stamm (1995, 2005) differed from Figley

(1995) in that Stamm argues that burnout is a byproduct of secondary traumatic stress, which influenced the characteristics of compassion fatigue.

Burnout. Burnout is a professional impairment from physical and mental exhaustion that that develops over time due to involvement in emotional demanding interactions and can impair an individual's outlook (Freudenberg, 1989; Maslach, 2003; Maslach, Schaufeli, & Leiter, 2001). Maslach (2003) identified a three factor model of burnout: (a) emotional exhaustion, (b) depersonalization, and (c) reduced personal accomplishment. As such, burnout may result to a reduction of the quality of care provided by counselors (Poghosyan, Clarke, Finlayson, & Aiken, 2010). In addition, burnout can result in dissatisfied work experiences with students and increase level of negative impressions of students (DeVoe, Fryer, Hargraves, Phillips, & Green, 2002; Soderfeldt, Soderfelt, & Warg, 1995). Impaired helping professionals operate with limited confidence and efficiency (Kottler & Hazler, 1996; Maslach, 2003; Norcross & Guy, 2007; Skovholt & Trotter-Mathison, 2011). Burnout is common amongst helping professionals (Kottler & Hazler, 1996; Norcross & Guy, 2007). As a result, the school counseling literature has various studies that examined burnout (e.g., Butler & Constatine, 2003; Lambie, 2007; Limberg, 2013; Moyer, 2011; Wilkerson, 2009; Wilkerson & Belinki, 2008).

Programmatic Service Delivery

The role of school counselors has evolved over time (Gysbers, 2010) and has received attention for oftentimes being ambiguous or unclear (Lambie & Williamson, 2004; Schmidt, 2008). However, ASCA (2012, 2013) takes measures to articulate a clear and concise role for counselors. Additionally, scholars have established a vision for developmental and comprehensive school counseling programs (Gysbers & Henderson, 2006). School counselors deliver intervention services to students through four modalities, including: (a) Counseling, (b)

Consultation, (c) Curriculum, and (d) Collaboration (ASCA, 2012; Scarborough, 2005). These interventions are forms of service delivery that facilitate the enhancement of students' social/personal, academics, and career development (ASCA, 2012). The defining roles, characteristics, and history regarding the school counseling profession is articulated in a few publications, including: (a) ASCA (2003, 2005, 2012) *National Model*, (b) ASCA (ASCA, 2013) *Position Statements*, and (c) ASCA (ASCA, 1997, 2004) *Standards for Students and School Counselors*.

ASCA National Model (2012). The ASCA *National Model* is a theory driven framework that articulated the various roles and tasks that are fulfilled by school counselors (ASCA, 2012). The initial ASCA (2003) *National Model* was developed with the goal of organizing and clarifying the roles that school counselors should manage which were formed by leaders in the counseling field (Gysbers & Henderson, 2006). The foundation of the ASCA *National Model* was first conceptualized in position statements made by ASCA in the 1960's and has progressed overtime to encompass the growing and diverse roles of school counselors (Gysbers & Henderson, 2006). The ASCA (2012) *National Model* is a refined framework that outlines the goals, objectives, and functions regarding the school counseling profession). Moreover, the ASCA (2012) *National Model* attempts to answer the following seven questions:

1. What do students need that the school counseling profession, based on its special body of knowledge, can best address?
2. Which students benefit from activities designed to address these needs?
3. What are school counselors best qualified to do to help them?
4. How do guidance and counseling relate to the overall educational program?
5. How can guidance and counseling be provided most effectively and efficiently?

6. How is a good school counseling program developed by a school?
7. How are the results of school counselors' work measured? (p. 83)

The ASCA (2012) *National Model* consists of four themes that delineate the tasks of school counselors. *Leadership* includes developing programs and initiative to support the counseling program and problem solving in the relevant communities. *Advocacy* refers to school counselors' efforts to represent the needs of students, families, and other stakeholders and promote high levels of standards for achievement. *Collaboration* entails working with students, families, teachers, administrators and other stakeholder to achieve the goals of the school counseling program and to support student development. The final theme in the ASCA *National Model* is *systemic change*, which represents the influences and support of systemic changes to support the need of students in diverse ways.

There are four components of comprehensive school counseling programs. *Foundation* includes the program focus, student competencies, and professional competencies (ASCA, 2012). The *management* component of school counseling programs relates to the ongoing organizational assessments with the goals of supporting and enhancing the school counseling program delivery mechanisms. Additionally, management includes an annual agreement that organizes expected yearly accomplishments and advisory council participation. *Accountability* encompasses the act of program evaluation regards the school counseling program. In accountability, school counselors evaluate services with the goal of guiding future interventions. The final component of the ASCA (2012) *National Model* framework is Delivery. *Delivery* represents the direct services that school counselors provide to students, families and other stakeholders, including direct students services (e.g., curriculum, student planning, and

responsive services) and indirect student services (e.g., consultation, coordination, and collaboration).

Appropriate service delivery activities. The ASCA (2012) *National Model* articulates the responsibility of school counselors. This study examined the activities and interventions related specifically to service delivery, including (a) curriculum, (b) counseling, (c) consultation, and (d) collaboration (Bodenhorn, 2005). However, counselors are often unable to perform their preferred activities as a result of situational and systemic barriers (Scarborough & Culbreth, 2008). In addition, school counselors may be asked or required to partake in non-counseling related activities.

Non-counseling related service delivery activities. Regularly, school counselors engage in activities that are *not* designated by the ASCA (2012) *National Model* (Dollarhide, 2003; Scarborough & Culbreth, 2008). These non-counseling activities may include substitute teaching, clerical work, discipline, hall/bus duty, medical issues, course scheduling (Gysbers & Henderson, 2006; Lambie & Williamson, 2004; Scarborough, 2005). The participation in such activities may lead to role conflict and ambiguity, poor professional identity, minimization of school counselor skills and abilities, impaired work wellness (Culbreth, Scarborough, Banks-Johnson, & Solomon, 2005; Lambie & Williamson, 2004; Lieberman, 2004; Woods, 2009). Thus, non-counseling related activities should be minimized with the goal of utilizing the school counselors' abilities for helping students.

Survey Research Methodology

Survey research is common in educational and social science and is one of the oldest researchers practices employed (Hackett, 1981). Surveys are tools used to gather information to describe respondent's knowledge, feelings, beliefs, values, behaviors, and states of mind (Fink,

2006). Status surveys seek to articulate the current status of a given or target population (Graziano & Raulin, 2006). Survey research studies involve the use of surveys, instruments, or questionnaires to learn about the current status of the target population (e.g., status survey) and the relationships among measured variables (Gall, Gall, & Borg, 2007; Graziano & Raulin, 2006; Johnson & Christensen, 2004).

Surveys can be conducted through multiple means of respondent interaction, including: (a) face-to-face interview, (b) telephone interview, (c) mail-out form, and (d) web-based form (Fink, 2006; Rea & Parker, 2005). Also, an integration of survey collection methods (e.g., mixed-methods; Dillman et al., 2009) can be utilized to optimize response rate. Respondent interaction type has developed over time based on cultural and technology changes (Dillman et al., 2009). Generally speaking, the interaction between participant and research has grown over time to be less interactive and more remote with more focus on the use of technology as a vehicle for obtaining participation in surveys. Survey research is a common practice in social science (Fink, 2006) and thus merits research that examines effective and/or ineffective methods to facilitate survey based studies.

Operational Definitions

ASCA (2012) National Model

The ASCA (2012) *National Model* is a theory driven comprehensive framework with themes and implementation components that constitute the activities and responsibilities of school counselors. The ASCA *National Model* provides school counselors guidance on the development, implementation, and ongoing facilitation of developmental and comprehensive school counseling programs.

Burnout

Burnout is defined as “a prolonged response to chronic emotional and interpersonal stressors on the job, and is defined by three dimensions of exhaustion, cynicism, and inefficacy” (Maslach et al., 2001, p. 1).

Compassion Fatigue

Compassion fatigue is the negative emotional and physical reaction that results from ongoing encounters with individuals who have experienced trauma or stressful life circumstances which is manifested in secondary traumatic stress and burnout (Figley, 1995; Stamm, 2010).

Compassion Satisfaction

Compassion satisfaction is defined as satisfaction found in being able to help other efficiently and effectively (Stamm, 2010).

Comprehensive School Counseling Program

Comprehensive school counseling programs are the organization, structure, and focus of the activities that school counselors participate in with the goal of supporting student personal/social, academic, and career development (ASCA, 2013; Gysbers & Henderson, 2006).

Item Nonresponse

Item nonresponse occurs when a respondent does *not* complete a specific item within a survey (Dixon & Tucker, 2010).

Nonprobability Sampling

Nonprobability sampling is the selection of participants in a manner that limits the opportunity for each member of a given population to be selected for participation (Gall et al., 2007).

Probability Sampling

Probability sampling is the selection of participants in a manner that gives each member of a given population an equal chance of being selected for participation (Gall et al., 2007).

School Counselor

Practicing school counselors are certified or licensed counselors with a minimum of a master's degree in school counseling who have the training and specialization to work in educational settings with the goal of supporting the personal/social, academic, and career needs of students through a developmental and comprehensive school counseling program (ASCA, 2009).

Secondary Traumatic Stress

Secondary traumatic stress is a condition of emotional distress resulting from close contacts with a person who experienced a traumatic or stressful event (Figely, 1995).

Self-Efficacy

Self-efficacy is defined as "beliefs in one's capabilities to organize and execute the courses of action required to manage prospective situations" (Bandura, 1995, p. 2).

Service Delivery

Service delivery constitutes the activities and interventions school counselors utilize to effectively support the personal/social, academic, and career needs of students in their school (ASCA, 2012).

Survey Research

Survey research involved the use of surveys, instruments, or questionnaires to learn about the current status of the target population (e.g., status survey) and the relationships among measured variables (Gall et al., 2007; Graziano & Raulin, 2006; Johnson & Christensen, 2004).

Token Incentive

A token incentive (monetary or non-monetary) is a gift given to potential respondents with the goal of encouraging them to participate in a survey (Dillman et al., 2009)

Unit Nonresponse

Unit nonresponse occurs when a sample unit (e.g., respondent) does *not* complete an entire survey (Dixon & Tucker, 2010).

Research Hypothesis and Exploratory Research Questions

This study examined the directional relationship between practicing school counselors' professional quality of life and self-efficacy in relation to their service delivery activities. This section presents the primary research question, research hypothesis, and exploratory questions. In addition, the measurement and structural models used for the research hypothesis are provided (Figures 1 to 4).

Primary Research Question

Do practicing school counselors' levels of professional quality of life (as measured by the ProQOLs [Stamm, 2010]) and their self-efficacy (as measured by the SCSEs[Bodenhorn & Skaggs, 2005]) contribute to their levels of service delivery (as measured by the SCARS [Scarborough, 2005])?

Research Hypothesis

School counselors' professional quality of life (as measured by the ProQOLs [Stamm, 2010]) and self-efficacy (as measured by the SCSEs [Bodenhorn & Skaggs, 2005]) contributes to their service delivery (as measured by the *SCARS* [Scarborough, 2005]). Specifically, this investigation tested the hypothesized directional relationship that practicing school counselors

scoring at higher levels of ProQOL and higher levels of self-efficacy would have higher levels of service delivery.

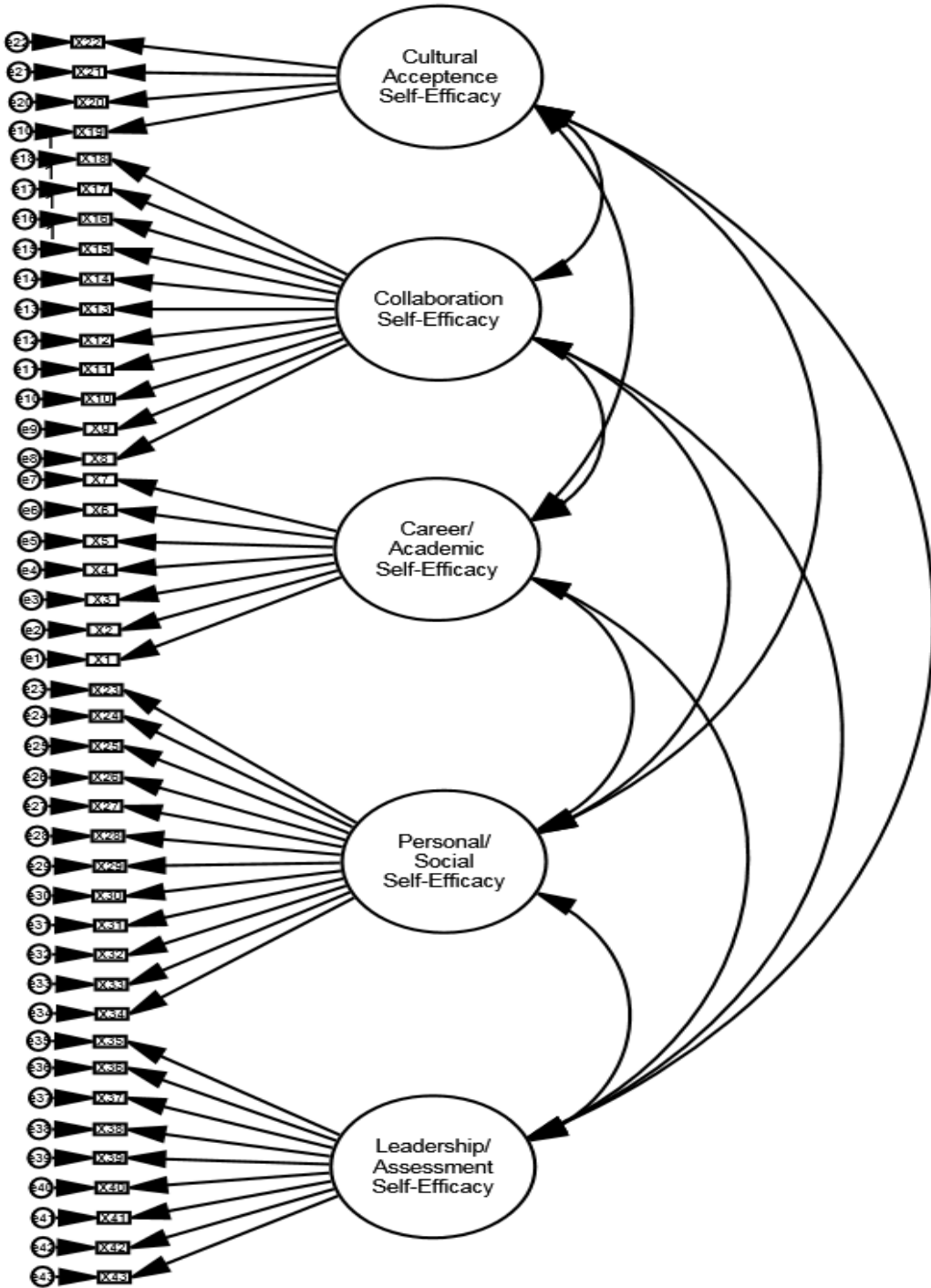

Figure 1: Measurement Model for the SCSEs (Bodenhorn & Skaggs, 2005)

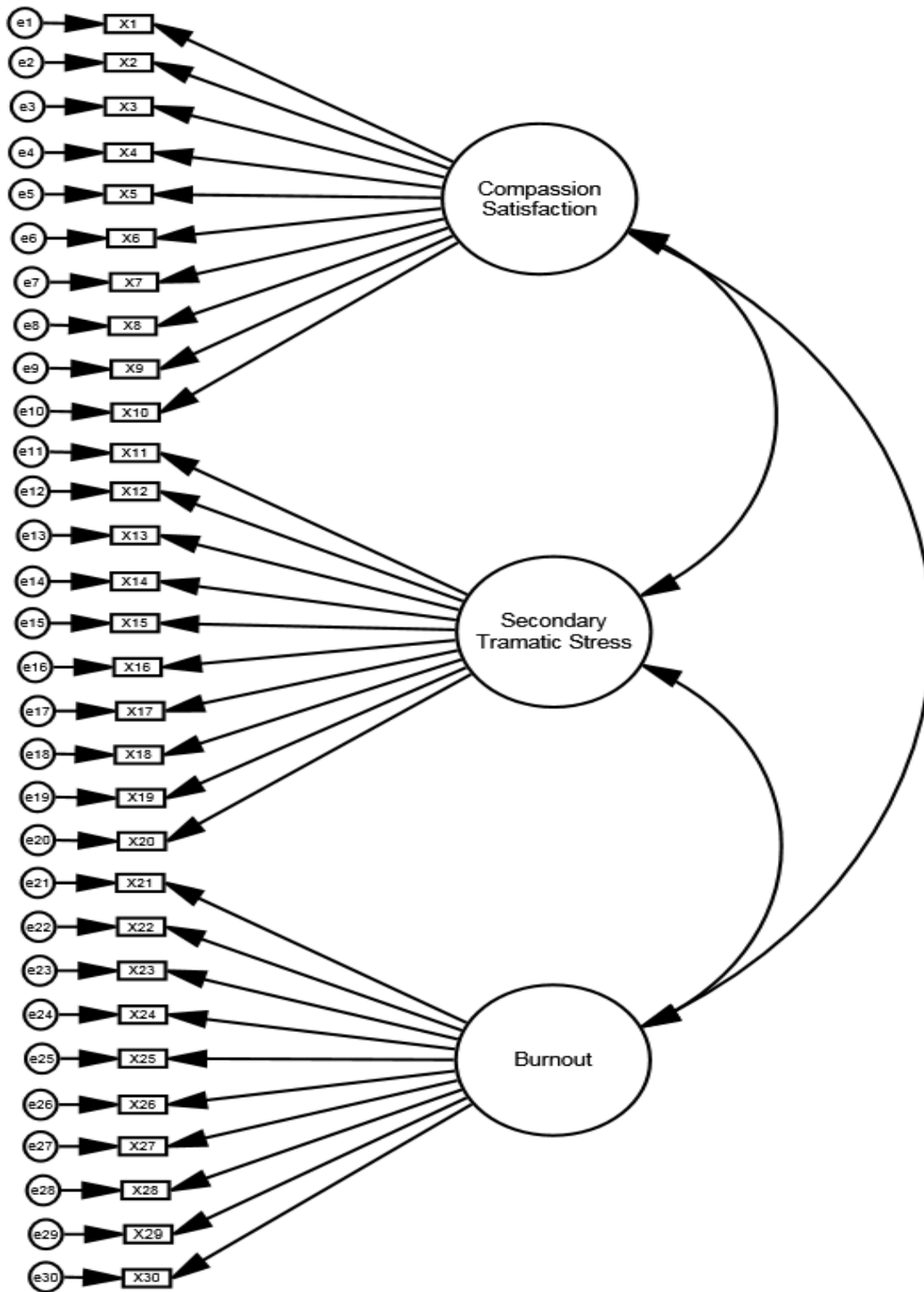

Figure 2: Measurement Model for the ProQols (Stamm, 2010)

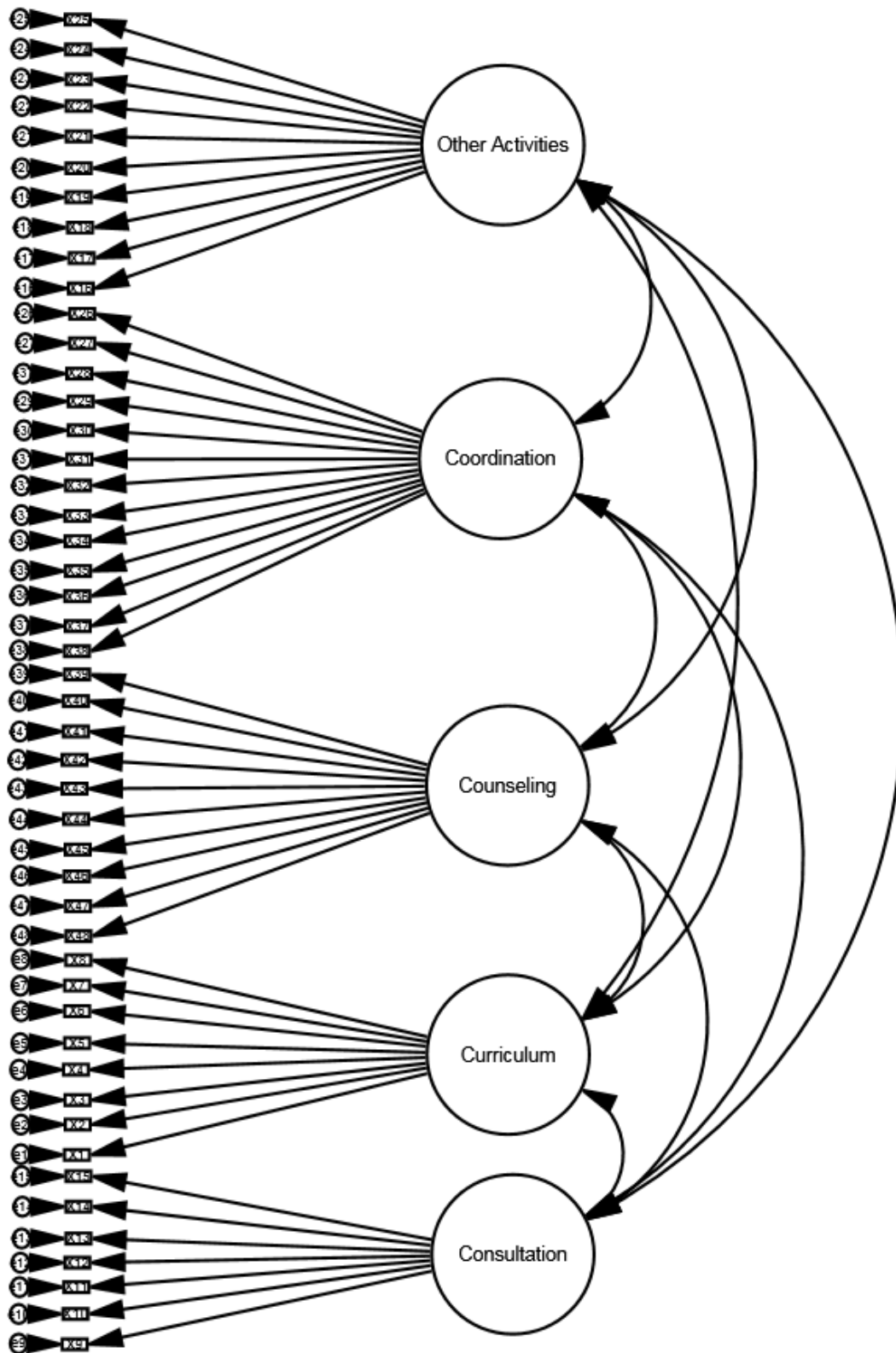

Figure 3: Measurement Model for the SCARS (Scarborough, 2005)

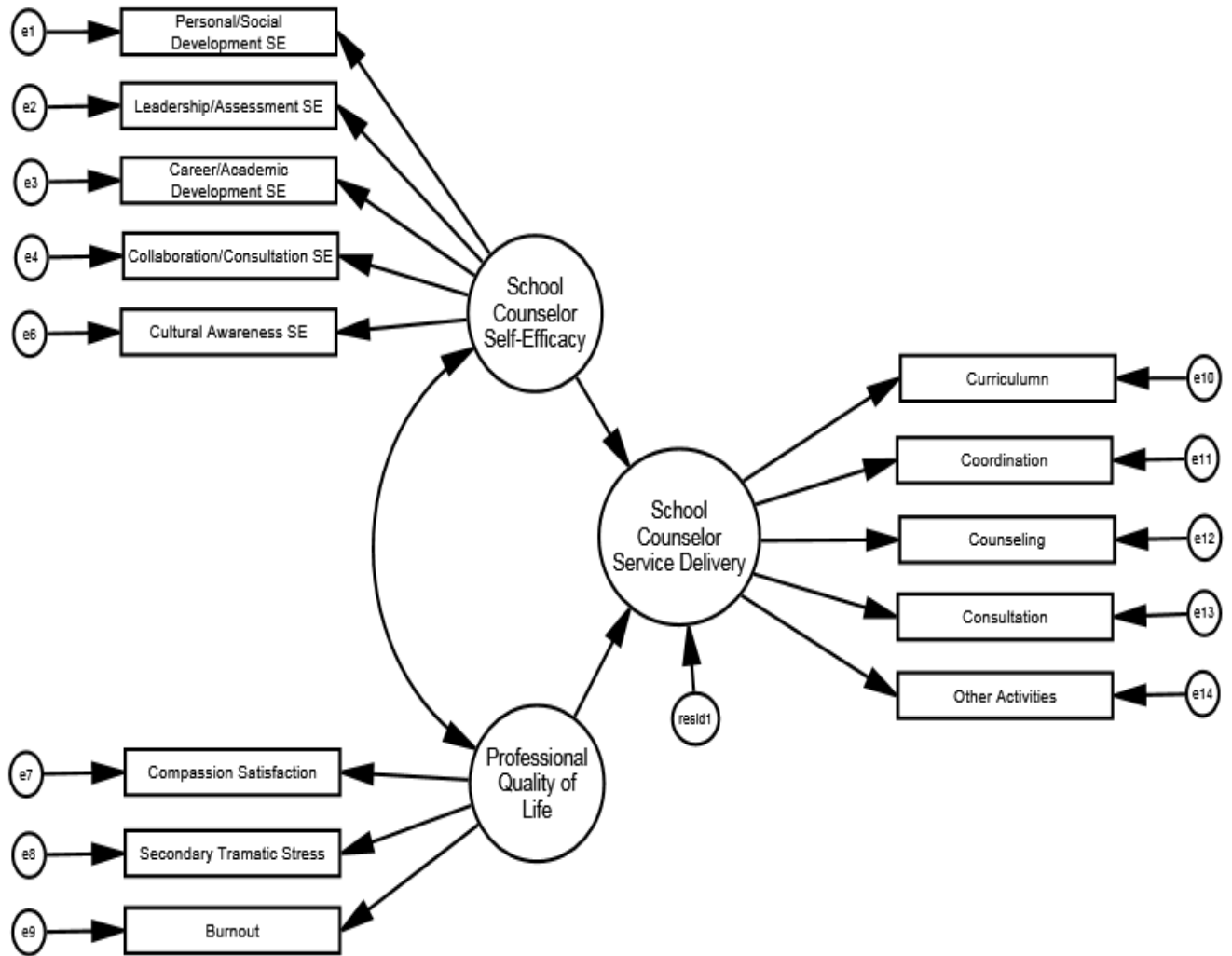

Figure 4: Path Diagram of the Structural Model to be tested

Exploratory Research Questions

1. What is the relationship between schools counselors' levels self-efficacy (as measured by the SCSEs [Bodenhorn & Skaggs, 2005]) and their reported demographic variables (e.g., age, gender, and ethnicity)?
2. What is the relationship between practicing schools counselors' service delivery (as measured by the SCARS [Scarborough, 2005]) and their demographic variables (e.g., age, gender, and ethnicity)?

3. What is the relationship between practicing schools counselors' professional quality of life (as measured by the ProQOLs [Stamm, 2010]) and their demographic variables (e.g., age, gender, and ethnicity)?
4. Is there a statistically significant difference in practicing school counselors' total and subscale scores on the SCSEs (Bodenhorn & Skaggs, 2005), ProQOLs (Stamm, 2010), and SCARS (Scarborough, 2005) based upon the (a) sampling method (e.g., email web-based, paper-pencil mail-out survey, face-to-face survey administration), (b) token incentive type (e.g., monetary [\$1.00, \$2.00, or no incentive] or non-monetary [\$1.00 donation to the American Red Cross or no donation]), and (c) sampling population (e.g., professional association membership or no professional association membership)?
5. Is there a statistically significant difference in practicing school counselors' response rate (as measured by completion of the SCSEs, Bodenhorn & Skaggs, 2005; ProQOLs, Stamm, 2010; and SCARS, Scarborough, 2005) based upon the (a) sampling method (e.g., email web-based, paper-pencil mail-out survey, face-to-face survey administration), (b) token incentive type (e.g., monetary [\$1.00, \$2.00, or no incentive] or non-monetary [\$1.00 donation to the American Red Cross or no donation]), and (c) sampling population (e.g., professional association membership or no professional association membership)?

Research Design

This study employed a descriptive, correlational research design to examine the research questions. The goal of correlational research is to examine the relationship between two or more

variables without the manipulation of variables (Gall, et al., 2007). In addition, correlational research is used to determine the direction and strength of the relationship between variables (Graziano & Raulin, 2006). However, correlation does *not* indicate causation (Graziano & Raulin, 2006; Stanley & Campbell, 1963). Nonetheless, the use of descriptive, correlational research supports the examination of cause and effect relationships between constructs and predictive outcomes (Tabachnick & Fidell, 2013). However, to provide evidence of cause and effect relationships researchers must check for the presence of three necessary conditions, including: (a) the variables being measured are related, (b) proper time order, and (c) the relationship is not due to a confounding factor (Cook & Campbell, 1979; Johnson & Christenson, 2004). In correlational research, investigators should always look for alternative explanations for the relationships found in the data (Fraenkel & Wallen, 2009).

Research Method

This study targeted practicing school counselors who work in an educational setting tailored to kindergarten to 12th grade students (e.g., elementary school, middle/junior high school, and high school). This targeted sample does *not* include potential participants that are primarily students (e.g., school counselors-in-training), administrators (e.g., assistant principals, principals, deans, district level staff), or counselor educators. According to the Common Core Data from the Federal Department of Education, there were 105,078 school counselors nationwide during the 2010-2011 school year (most recent available school year). Therefore, to generalize the results to the population of practicing school counselors in the United States with a 95% confidence level, a minimum random sample of 384 was required (Krejcie & Morgan, 1970).

The study utilized convenience sampling of school counselors in three separate data collection methods with unique samples. First, a sample of participants from three separate, diverse school districts from across the United States were invited to participate in the study during a face-to-face administration of the survey (with approval from the IRB; Hox, & DeLeeuw, 1994). During this data collection, participants were given the instrument packet and invited to take the survey. This group of school counseling participants did *not* receive an incentive. It was estimated that this sample group would contribute 200 participants.

The second sampling method included mail survey using mixed methods (Dillman et al, 2007; Greenlaw, & Brown-Welty, 2009). A sample of participants received a paper-pencil mailing of survey instrumentation and had the option of mailing back the completed survey or completing the survey online. This mail survey sampling method drew from two sources of potential respondents, including: (a) ASCA membership database and (b) a random selection of school counselors from the Common Core Dataset list of school in the United States (U.S.). For ASCA membership database, the researcher contacted an ASCA staff members to obtain the mailing addresses of 2,000 practicing school counselor members (randomly selected) to use in the mailing of the paper-pencil mixed mode surveys (the cost of the mailing addresses is \$250.00). Regarding the participants from the Common Core Dataset, the researcher extracted a list of every school in the country. Then, the researcher randomly identified 250 schools using Microsoft Office's excel RAND option. Of these schools, the researcher identified a school counselor for the school. However, to minimize bias in the school counselor selection, the researcher randomly selected (using Microsoft Office's excel RAND option) a single counselor. In total (e.g., ASCA Membership and Common Core Dataset participants), the mail survey sample group targeted 600 participants with an expectation that 50% ($N = 300$) of counselors

may complete the survey based on prior research study using a similar methodology (e.g., Bodenhorn, Wolfe, & Airen, 2010; Lawson, 2007; Sutton & Hall, 1995; Wolfe et al., 2009).

The third sampling method included the use of online survey methods (Dillman et al., 2009). For the online survey sampling method, 3,000 participants were selected from ASCA's online membership directory. The online directory is available for members of ASCA to use in connecting with other ASCA members. ASCA members have the option to post their email address and other professional information in the directory upon joining ASCA. Importantly, these potential participants were screened to assure they are practicing school counselors and not students, administrators, or counselor educators. Permission to use the ASCA online directory was granted through personal communication (through e-mail) with Kathleen Rakestraw, the Director of Communications for ASCA. Specifically, the researcher selected individuals from this online directory who are practicing school counselors and who are *not* already included in the other two sampling pools. Then, these potential participants were emailed an invitation to an online version of the study. Response rate for this population may vary, however, the researcher expects 300 (10% response rate) participants based on previous research (Limberg, 2013; Mullen, Lambie, & Conley, 2014; Shih & Fan, 2009; Wolfe et al., 2009).

As a result of these three sampling populations, this investigation expected to have approximately 800 participants. The diverse sampling methods were established with the goal of obtaining as comprehensive and accurate representation of practicing school counselors. Response rate is often viewed as an indicator of quality regarding the participants' responses (Hox & DeLeeuw, 1994); however, inconsistency in these findings may indicate that the non-response is *not* as important as many believe (Shih & Fan, 2009). Therefore, this study's comprehensive sampling methods examined the response variance based upon the sampling

groups. If similar scores are found amongst the different sampled populations then the researcher can conclude: (a) all the data equally represents the constructs being measured and (b) the sampling methods are equivalent despite the variance in response rate (Shih & Fan, 2009). The results concerning sampling methodology can inform researchers surveying school counselors; thus, supporting more rigorous research methods for the field.

Data Collection Procedures

This study used both convenient and simple random sampling. Convenience sample is a method of selecting participants when using one or more pre-identified groups (Fraenkel & Wallen, 2009). Moreover, convenience sampling is a non-probability sampling technique that is characterized by targeting specific areas or groups for a study to obtain a representative sample (Kerlinger, 1986; e.g., geographical representation). Simple random sampling is the process of selecting a sample of participants from a larger population in a way that every person has an equal chance of being chosen for participation (Fraenkel & Wallen, 2009). The face-to-face populations were the convenience sampling methods. The ASCA members and online directory and the potential participants from the Common Core Data set were randomly identified to participate in this study. Thus, the participants were both general practicing school counselors and practicing school counselors who are members of ASCA. Prior to any collection of data, the researcher applied for permission from the University of Central Florida's Institutional Review Board (IRB) to conduct the study. Once IRB approved the proposed research, initial contact was made with the school district leaders to inquire about participation in the study. The researcher identified districts that varied in location (e.g., urban, suburban, and rural) and size. Also, the researcher identified school districts that were geographically different (e.g., in different states). Lastly, the researcher identified districts that were feasible (e.g., accessible based upon the

financial ability and time availability of the researcher) to involve in the study. If the school district allowed the study to take place, the researcher completed the needed forms to administer the surveys at the willing school districts' *Offices of Evaluation and Research* to obtain permission to conduct the study. Moreover, permission to use the instruments (*ProQOLs* [Stamm, 2010]; *SCSEs* [Bodenhorn & Skaggs, 2005]; and *SCARS* [Scarborough, 2005]) was verified.

To reduce measurement error, the instruments were checked, rechecked, and piloted to assure legibility and understandability (Dillman et al., 2009). The researcher checked and rechecked the instruments for legibility and understandability. Then, the researcher had 10 colleagues (e.g., researchers) pilot the instruments for legibility and understandability. Then, the instruments (e.g., *ProQOLs*, *SCSEs* and *SCARS*) and the consent and demographics were formatted to support legibility and understandability. Feedback from the colleagues and dissertation committee was incorporated into the development of the instrument packets.

First, the survey was administered at the school counseling professional development meetings per school district during the Fall 2013 school year. The researcher scheduled the dates to meet with each school counseling coordinator individually and collect the data from the participating school counselors. The participants were able to opt out of participating or withdrawal at any time from the study (e.g., informed consent; General Demographics Form; *ProQOLs* [Stamm, 2010]; *SCSEs* [Bodenhorn & Skaggs, 2005]; and *SCARS* [Scarborough, 2005]). Each participant received an envelope that has *no* identifying information. If they wish to opt out of the study, they simply turn in an incomplete/blank envelope. If they choose to participate, they completed the instruments and sealed the envelope. Either way, when the participants are finished they return the envelope back to the researcher. Once all the participants

completed the data collection packets, the researcher thanked the participants and left. All envelopes were sealed and kept sealed until the researcher begins the data entry process. When the data entry process begins, each participant's survey instruments were coded with a number to track that envelopes score and results. No identifying information (e.g., name, employee id, address) was collected.

After the in person administration, participating school districts were offered the opportunity to have the researcher present the findings and their implications to the districts school counselors. Additionally, the researcher offered to provide a video module with an assessment on the topic of school counselor career sustaining mechanisms for the district's ongoing use.

The second method of data collection was through mixed-method, paper-pencil mail out of instrumentation packets. In the paper-pencil mail collection method, participants received the same aforementioned instrumentation packet. However, the paper-pencil mail method followed the recommended *Tailored Design Method* to surveying (Dillman et al., 2009). The following steps took place: (a) participants were mailed a postcard notifying them of the impending study; (b) after three days, participants were mailed an initiation letter and instrument packet (e.g., informed consent; General Demographics Form; *ProQOLs* [Stamm, 2010]; *SCSEs* [Bodenhorn & Skaggs, 2005]; and *SCARS* [Scarborough, 2005]); (c) after one week, participants were mailed a reminder/thank you post card; (d) after two weeks, non-respondent participants were mailed another instrument packet; and (e) after three weeks, non-respondent participants were mailed a final request to participate. In addition, when participants receive the letter inviting them to participant and instrumentation packet (second step), they had the option to complete the survey online or by completing and returning the instrumentation packet. All participants were assigned

a *personal access code* to use when completing the survey to support their anonymity. Copies of these letters are included in the appendix.

Response rate is an important survey research design concern (Hox, & DeLeeuw, 1994). The best encourager of survey completion is multiple contacts; second to multiple contacts is incentive (Dillman et al., 2009). Incentive in survey research increases response rate (Church, 1993). Moreover, Dillman and colleagues (2007) indicate that the largest increment in response rate is the results of going to \$0 incentive to \$1 incentive; however, as the amount of incentive increases, so does the likelihood of response rate (Dillman et al., 2009). In regards to school counselor survey research, Wolfe and colleagues (2009) found that nonresponse is higher with web-based surveys as compared to mail surveys. Furthermore, they identify the need to examine response rate issues to support research with school counselors (Wolfe et al., 2009). Therefore, on the initial mailing, participants received either (a) no incentive, (b) one-dollar token incentive, or (c) two-dollar token incentive for participating in the study. The varied incentive sought to identify an effective incentive for school counselor survey research. These groups were randomly assigned to all mixed-method, mail-out survey recipients.

The final sampling method includes email/web-based survey. The email/web-based survey method included following *Tailored Design Method* (Dillman et al., 2009). Participants were randomly selected from the ASCA online membership directory. The instrument packet used in each described administration was converted into an online survey using Qualtrics.com. Each participant received three emails through Qualtrics.com. The first email was an introduction to the study, a link to participate, and information regarding the IRB approval. The second e-mail was a reminder email for any individuals who did not complete the study. The third and final email was another reminder email. The appendix contains copies of each email,

which are developed based on *Tailored Design Method*. Participants received a non-monetary incentive. Specifically, if they participated, a donation of \$1 was made to the American Red Cross. The use of nonmonetary incentive is an effective and efficient method to increase response rate in electronic surveys (Church, 1993). Table one provides a summary of the research sample and sampling procedures.

Instrumentation

General Demographics Questionnaire

This study utilizes a general demographics questionnaire to collect participant data and self-report information. The general demographics form was created by the researcher and can be found in the appendix. The general demographics questionnaire requests the following information from participants: (a) ethnicity; (b) age; (c) gender; (d) current school level (e.g., elementary school, middle/junior high school, and high school); (e) years of experience as a teacher prior to the current year (zero indicates no teaching experience); (f) years of experience as a school counselor prior to current year (zero indicate it is their first year as a school counselor); (g) school location (e.g., rural, urban, suburban); (h) type of school setting (e.g., regular school [private or public], career center, special education center, alternative education), and (i) current professional membership.

In addition, the general demographics questionnaire included several five-point Likert scaled statements that assess following topics: (a) principal-counselor relationship, (b) job control, (c) job satisfaction, and (d) job stress. These topics addressed issues related other studies conducted on service delivery (e.g., Clemens et al., 2010). Each topic is addressed through three separate items developed by the researcher. The psychometrics of these items was assessed using

the data from this study. To support the face validity and reliability, the dissertation committee, research colleagues, and school counseling professionals reviewed these items.

Professional Quality of Life Scale

The ProQOLs(Stamm, 2010) is a 30-item self-report instrument that measures two compassion factors, which include compassion satisfaction and compassion fatigue. Compassion fatigue is broken into to subscales, which include burnout and compassion fatigue (e.g., secondary traumatic stress). Overall, the ProQOLs consists of three subscales, including: (a) compassion satisfaction (10 items), (b) burnout (10 items), and (c) compassion fatigue (10 items).

Initially, the ProQOLs was called the *Compassion Fatigue* and has undergone several versions based on the emergence of research (Figley, 1995; Figley & Stamm, 1996; Stamm, 2005). The ProQOLs seeks to assess both the positive and negative factors associated with ones' profession (Stamm, 2010). In addition, the ProQOLs has been used with a wide variety of professions (e.g., health care professionals, teachers, and social service workers) and has a large base of supporting literature (Stamm, 2010).

To score the ProQOLs, researchers first need to reverse score items one, four, 15, 17, and 29. Then, researchers sum the items for each subscale. Last, the Stamm (2010) recommends researchers convert the Z-scores into t-scores; however, not all researchers convert the scores (e.g., Lawson & Meyers, 2011). The norm group summed scores for the scales ($N = 967$) are: Compassion Satisfaction ($M = 37.00$, $SD = 7.30$), Burnout ($M = 22.00$, $SD = 6.80$), and Compassion Fatigue ($M = 13.00$, $SD = 6.30$). Stamm reported the following Cronbach's Alphas for the subscales: Compassion Satisfaction (.88), Burnout (.75), and Secondary Traumatic Stress

(.80). In addition, the subscale intercorrelations were low, supporting the construct validity of the ProQOLs.

Psychometric properties of the ProQOLs. The ProQOLs has been used in multiple studies that examine counseling practitioners. Lawson (2007) examined the career sustaining behaviors and ProQOL of 1,000 American Counseling Association (ACA) members. The study produced a 50.9% response rate ($N = 501$) with 88 participants who work in K-12 settings. The average scores on the three scales were: Compassion Satisfaction ($M = 39.84$, $SD = 6.43$, $\text{Alpha} = .77$); Compassion Fatigue ($M = 10.05$, $SD = 5.91$, $\text{Alpha} = .85$); and Burnout ($M = 18.37$, $SD = 6.00$, $\text{Alpha} = .82$). Lawson (2007) found that those participants in K-12 settings scored ($M = 19.70$, $SD = 6.29$) lower on the Burnout scale than their counterparts in community settings ($M = 19.84$, $SD = 6.88$) but higher than practitioners in private practice ($M = 15.77$, $SD = 6.04$) $F(5, 456) = 8.22$, $p = .000$. Additionally, K-12 practitioners scored ($M = 11.89$, $SD = 6.40$) higher in Compassion Fatigue when compared to private practitioners ($M = 8.26$, $SD = 5.25$) and practitioners in community settings ($M = 10.31$, $SD = 5.78$) $F(5, 456) = 5.78$, $p < .035$. There were *no* significant group differences in Compassion Satisfaction scale scores. Also, there were *no* significant differences in the ProQOLs scores and demographic factors.

In a separate study, Lawson and Meyers (2011) examined the levels of counselors' wellness, ProQOL, and career sustaining behaviors, the group's differences for these variables, and the relationships for these variables. The authors used paper pencil mail survey methods with 1,000 ACA members, which resulted in a 51.7% response rate ($N = 506$). Of the 506 participants, 20.6% work in K-12 setting. Importantly, the authors used the third version of the ProQOLs. This sample yielded the following internal consistency coefficients: Compassion Satisfaction (.84), Burnout (.78), and Secondary Traumatic Stress (.80). Additionally, the third

version of the ProQOLs produced the following mean scores: Compassion Satisfaction ($M = 40.52, SD = 5.57$), Burnout ($M = 19.93, SD = 5.96$), and Compassion Fatigue ($M = 10.32, SD = 5.98$). The authors concluded that counselors working with more clients/students with a history of trauma were at a higher risk for burnout. In addition, those counselors working with high-risk clients had higher levels of burnout and had lower levels of compassion satisfaction.

School Counselor Self-Efficacy Scale

The SCSEs (Bodenhorn & Skaggs, 2005) is a self-report instrument that consists of 43-items, which is designed to measure the self-efficacy of school counselors'. In addition, the SCSEs include subscales that measure school counselors' confidence to facilitate job roles in five specific areas. The areas that the SCSEs measures include: (a) personal and social development (12 items), (b) leadership and assessment (nine items), (c) career and assessment (seven items), (d) collaboration (11 items), and (e) cultural awareness (four items). The instrument utilizes a five-point Likert scale (1 = Not Confident, 2 = Slightly Confident, 3 = Moderately Confident, 4 = Generally Confident, 5 = Highly Confident).

The SCSEs (Bodenhorn & Skaggs, 2005) was developed in four separate studies. The first study consisted of two steps. Initially, the authors reviewed the *National Standards for School Counseling* (Campbell & Dahir, 1997), the CACREP (2001) *Standards*, and established counseling based self-efficacy scales. The initial SCSEs item develop process resulted in the original 44 items. Then, they presented the SCSEs to a panel of five experts in school counseling, which resulted in 51 items.

The second study included dissemination of the new instrument to 582 ASCA conference attendees through a survey by email, which resulted in 226 respondents (a 38.7% response rate; Bodenhorn & Skaggs, 2005). Eight items on the scale were initially deleted either due to a high

degree of nonresponse by participants (an indicator of a confusing or poorly worded item) or poor discrimination (low variance in responses). The mean across all items was 4.21 ($SD = .67$, range = 3.50 to 4.85). The mean of the total scale score was 180.97 ($SD = 19.86$). In addition, the authors reported high item correlation. In examining group differences (using Analysis of Variance [ANOVA]), the authors found significant difference in the following areas: (a) participants' gender $F(1, 223) = 6.81, p < .05, R^2 = .03$ with females reporting stronger self-efficacy than males; (b) participants' with teaching experience having higher self-reported self-efficacy $F(1, 223) = 8.235, p < .01, R^2 = .04$ with participants with teaching experience having higher self-reported self-efficacy; and (c) participants' with more experience as a school counselor having higher self-reported self-efficacy $F(1, 220) = 7.04, p < .01, R^2 = .03$.

The third study was disseminated to counselor educators at 22 universities who administered it to 326 school counselors-in-training to with a 36% response rate ($N = 116$) (Bodenhorn & Skaggs, 2005). This study paired the SCSEs with other instruments to assess the construct validity by examining interment correlations. The other scales used included the *Counseling Self-Estimate Inventory* (COSE; Larson et al., 1995), the *Social Desirability Scale* (SDS; Crowne & Marlowe, 1960), the *State-Trait Anxiety Inventory* (STAI; Spielnerger, 1983), and the *Tennessee Self-Concept Scale* (TSCS 2; Fitts & Warren, 1996). The results identified the following relationships: (a) COSE ($n = 28; r = .41, p < .05$); (b) SDS ($n = 25; r = .30, p > .05$); (c) STAI; State ($n = 38; r = -.41, p < .05$), Trait ($n = 38; r = -.31, p > .05$); and (d) TSCS 2 ($n = 28; r = .16, p > .05$). These results supported the concurrent validity of the SCSEs but should be interpreted with caution because the investigation used a nonprobability sample and cannot be generalized to the population of practicing school counselors.

The fourth study conducted to develop the SCSEs included the combination of all the data collected from study two and three for item analysis, which resulted in 342 total respondents (Bodenhorn & Skaggs, 2005). The authors used principal component analysis with a resulting eight-factor solution that accounted for 65% of the variance. Then, the authors reviewed the scree plot and examined the breaks, resulting in breaks after one, two, five, and eight. They tested each solution using an oblique rotation (e.g., direct oblimin) seeking to find the simplest structure that aligns with theory. The result of their investigation was a five-factor solution that accounted for 55% of the variance. The subscale coefficient alphas were: personal and social development (.91), leadership and assessment (.90), career and assessment (.85), collaboration (.87), and (e) cultural awareness (.72).

Psychometric properties of the SCSEs. The SCSEs (Bodenhorn & Skaggs, 2005) has been used in multiple studies that support its validity and reliability with diverse samples. Bodenhorn and colleagues (2010) examined the relationship between school counselor self-efficacy (using the SCSEs), school counselors' awareness and utilization of achievement gap data, and school counseling program choice. The study surveyed 1,600 ASCA members with a response rate of 54% ($N = 860$), and coefficient alpha was .97 with these data. They found that school counselors' knowledge regarding program choice is related to their self-efficacy. In addition, Bodenhorn et al. (2010) found that school counselors' with higher levels of self-efficacy have a higher likelihood to implement the ASCA *National Model* as compared to school counselors with lower levels of self-efficacy. Scoles (2011) surveyed 129 members of the Ohio School Counselors Association comparing the self-efficacy of members who held teaching experiences versus those who did *not* have prior teaching experience. The results identified differences in three of the subscales (e.g., Personal and Social Development, Leadership and

Assessment, and Collaboration). The Cronbach's alphas for the SCSEs subscales in this study were as follows: personal and social development (.88), leadership and assessment (.90), career and assessment (.84), collaboration (.82), and (e) cultural awareness (.68) with an overall Cronbach alpha of .96.

School Counselor Activity Rating Scale

The SCARS was developed by Scarborough (2005) as a self-report instrument to measure the service delivery activities and roles of school counselors. The SCARS was developed due to two main factors: (a) the need to assess the effectiveness of school counselors and advocate for their role in schools and (b) the paucity of valid and reliable instruments to measure how counselors spend their time. Therefore, Scarborough developed the SCARS to assess preferred and actual job duties that are carried out by school counselors. The SCARS provides information on both how school counselors spend their time and the discrepancy between how they would like to spend their time and what they actually do.

The SCARS was developed in two steps. First, the Scarborough (2005) designed the task statements, rating scale, and format of the instrument. The task statements were derived from prescribed by the ASCA (1999, 2003) *National Model* to reflect the identified roles of school counselors. The second step in the development of the SCARS included a pretesting of the instrument. During the pretest, Scarborough (2005) assessed for production mistakes, readability, and understanding by conducting interviews with two individuals who took the scale, one took the scale in the presence of the interviewer and the other took it first and then provided input. Both forms of feedback provided the researcher with feedback to improve the SCARS. Next, the researcher had five colleagues (experts in school counseling) review the SCARS to provide

additional feedback. Feedback from both groups guided the wording, style, and format of the scale.

The SCARS was initially tested with 50 total items (Scarborough, 2005). The researcher conducted an exploratory factor analysis study (principal components factor analysis; orthogonal transformation; varimax rotation). The sample consisted of 600 participants (100 per level – elementary, middle/junior high, and high school) from two southern states. Scarborough used *Tailored Design Method* survey to collect the data. The resulting usable response rate was 60% with 117 elementary school counselors, 120 middle/junior high school counselors, and 124% high school counselors. The average years of experience of the participants was 11, including 27.9% of them having five or fewer years of age.

The results of the investigation (Scarborough, 2005) supported a four-factor solution for both the *Actual* and *Preferred* scales for the original 40 items that measures the four main subscales (e.g., Counseling [10 items], Consultation [7 items], Coordination [13 items], and Curriculum [8 items]; Scarborough, 2005). The reliability (Cronbachs Alphas) of these individual scales were as follows: (a) Counseling (Actual = .85; Preferred = .83), (b) Consultation (Actual = .75; Preferred = .77), (c) Coordination (Actual = .85; Preferred = .85), and (d) Curriculum (Actual = .93; Preferred = .90). Regarding the sub-scale for Other School Counseling Activities, the results support a two-factor solution; however, the author utilized a three factor solution to enhance the meaning of the subscales (Clerical [three items], Fair Share [five items] and Administrative [two items]). The reliability (Cronbachs Alpha) of these individualSCARS scales were as follows: (a) Clerical (Actual = .80; Preferred = .84), (b) Fair Share (Actual = .58; Preferred = .58), and (c) Administrative (Actual = .43; Preferred = .52). The

scales Fair Share and Administrative have low reliability levels (e.g., $>.60$), which means the scales should be interpreted with caution.

The author established the construct validity of the SCARS through the examination of group differences ($N = 360$) based on their school level (elementary, middle/junior high, and high school; Scarborough, 2005), which resulted in a significant difference between school levels. The author examined correlations between subscales and demographic factors (e.g., years of experience) to review discriminate validity, which resulted in two significant correlations between Coordination ($r = .21, p < .001$) and Consultation ($r = .19, p < .001$) and years of experience. However, it is important to note that the results of the correlations between the SCARS subscale scores and demographic factors had small effect sizes (Cohen, 1988).

The resulting version of the SCARS consists of 48 items (Scarborough, 2005) that measures school counselor activities. Specifically, the SCARS has five subscales, including: (a) *Counseling* (10 items) - activities in which counselors provide individual and group counseling; (b) *Consultation* (seven items) - activities in which counselors working with stakeholder to meet student needs; (c) *Coordination* (13 items) - activities in which counselors manage, evaluate, and implement counseling programs; (d) *Curriculum* (eight items) – activities in which counselors facilitate classroom lessons; and (e) *Other Activities* (10 items) - activities in which counselors perform non-counseling tasks. Participants rate their Actual and Preferred activities on a five point Likert Scale in two separate columns. The rating scale (1-5 respectively) is as follows: (a) Never, (b) Rarely, (c) Occasionally, (d) Frequently, and (e) Routinely. Researchers can use both total scores (total score for each subcategory) and mean scores (e.g., divide the total number of item by the total score in each subscale). Participants who score higher indicate greater levels of

engagement in the designated counselor activity. For this study, permission was requested to only obtain *Actual* score from participants.

Psychometric properties of the SCARS.The SCARS (Scarborough, 2005) has been used in multiple studies that support its reliability and validity with diverse samples. For example, Clark (2006) examined school counselors' ($N = 118$) self-efficacy in relation to the ASCA(2005) *National Model* using the SCARS, and identified Cronbach Alpha scores ranging from .78 to .91. The results of Clark's study indicated that there is a relationship between the SCARS and the *School Counselor Self-Efficacy* (SCSEs; Bodenhorn & Skaggs, 2005) scale. In addition, Hebert (2007) used the SCARS with 305 school counselors to examine the time spent on specific tasks. Herbert's Cronbachs Alpha scores ranges from .61 to .96, with coordination being the least reliable. Herbert reported that missing data contributed to the unreliability of coordination. Shillingford and Lambie (2010) explored the relationship between school counselor activities (as measured by the SCARS; Scarborough, 2005), leadership qualities, and values. Their results indicated an overall Cronbachs Alpha reliability score of .73. The findings of Shillingford and Lambie's study confirmed a revised hypothesized model ($\chi^2 = 65.337$, $df = 49$, $p = .059$) that indicated the school counselors' leadership practices and values contribute to the service activities they facilitate. The next section of the chapter presents the research design for the proposed investigation.

Data Analysis

The data analysis for this study was derived from two collection sources: (a) in person administration at multiple sites and (b) mixed-mode, mail out surveys to ASCA Members and identified school counselors from the Common Core Dataset. Participants completed the following instruments: (a) *general demographics form*, (b) *SCSEs* (Bodenhorn & Skaggs, 2005),

(c) ProQOLs (Stamm, 2010), and (d) SCARS (Scarborough, 2005). Data was collected in paper-pencil format or through an online survey and then inputted into Statistical Package Social Sciences (Version 21; SPSS, 2011). The data analysis used both SPSS (for data cleaning/management and Multiple Linear Regression [MLR]) and Analysis of Moment Structures (AMOS; Version 21) software program.

Initially, the data was cleaned (e.g., find and examine missing data). Listwise deletion method was used to handle missing data (Tabachnick & Fidell, 2013). Next, the statistical assumptions were tested to ensure the appropriateness of the data for the desired analysis (i.e., SEM and MLR). Specifically, the researcher tested for normality, homogeneity, and multicollinearity.

Statistical Method used to examine the Research Hypothesis

This study employed correlational data analysis. Specifically, SEM (also known as Latent Variable Modeling) was used to analyze the research hypothesis. SEM is “a sophisticated method of multivariate correlational research” that “can be used to test theories of casual relationships” (Gall et al., 2007, p. 371). In addition, Tabachnick and Fidell (2013) state that SEM “is a collection of statistical techniques that allow a set of relationships... to be examined” (p. 681). SEM is a combination of both *multiple regression analysis* and *confirmatory factor analysis* and is used to examine the directional relationships of the variables being measured (Tabachnick & Fidell, 2013). However, SEM is a confirmatory approach that is used to test a theory (Tabachnick & Fidell, 2013).

This study used SEM to test a theoretical model that contains both manifest and latent variables. Manifest variables are the direct observations as measured by the scales (Schumacker & Lomax, 2010). Latent variables are the theoretical constructs that are formed by the manifest

variables (Schumacker & Lomax, 2010). In this study, the latent variables are school counselor self-efficacy, ProQOL (e.g., mental and physical ProQOL), and school counselor service delivery. The investigation's manifest variables consist of the individual items and subscales on the three data collection instruments.

Statistical Methods used to examine Exploratory Research Questions One, Two, and Three

The exploratory research questions one, two, and three were studied using several statistical analyses. First, the researcher examined the descriptive statistics. Then, the researcher examined the independent correlations (e.g., relationships) between the constructs e.g., self-efficacy, ProQOL, and service delivery) and demographic factors (e.g., age, gender, ethnicity, level of education, length of experience as a school counselor, length of experience as a school counselor, and student caseload) using Pearson Product Moment Correlations. Next, MLR examined if the constructs are predicted by the demographic factors. Last, the mean scores between variables were compared using analyses of variances (ANOVA).

Statistical Methods used to examine Exploratory Research Questions Four and Five

The exploratory questions four and five employed multiple methods of data analysis. First, unit nonresponse rate (total possible response - total completed response = unit nonresponse rate) were calculated based on data collection method, sample population, and incentive type. Then, mean score of the SCSEs, ProQOLs, and SCARS instruments were compared using several ANOVAs with data collection method, sample population, and incentive type as the separate grouping variables. Post hoc tests were be used if significant was found. Last, separate logistic regression analysis by data collection method and sampled population was be used to predict participants' tendency to response based on demographic factors and incentive type.

Ethical Considerations

The ethical considerations that were considered by the IRB and the researcher's dissertation committee include the following:

1. Participants' data was collected *anonymously* and secured to protect *confidentiality*.
2. Participation in this study was voluntary and did *not* have an impact on participants' employment.
3. Participants were informed of their rights as participants of this study.
4. Participants were able to withdraw at any time from the study without consequence or retribution.
5. Participants were given an Explanation of Research that was approved by the IIRB.
6. The researcher obtained permission to use *all* of the instruments used in this study prior to collecting data.
7. The researcher conducted this study after obtaining permission and approval from the dissertation chairs, the committee members, the individual school districts, and the IRB at the University of Central Florida.

Potential Limitations of the Study

Several limitations exist for this study. First, the research being conducted is correlational; thus, causality cannot be concluded from the results (Stanley & Campbell, 1963). In addition, correlational research is susceptible to the threats to validity, including: external validity, internal validity, and construct validity. Furthermore, the data being collected is self-report and may *not* be the most accurate measure for the constructs. Moreover, the sampling was convenient, which may *not* be inclusive of all school counselors. As well, the survey packets

contain four collection forms with a large amount of item that participants are asked to answer; hence, the length of the packet may have contributed to non-response bias.

Chapter One Summary

The purpose of chapter one was to introduce the study. The constructs for this study were presented, along with the rationale for the study, significance of the study, and operational definitions. The research design was reviewed, including the population and sampling procedures, data collection methods, research hypothesis and exploratory research questions, research method, and data analysis. In addition, the ethical considerations and limitation were presented. A need exist to examine the contributionof school counselors' self-efficacy and professional quality of life to their programmatic service delivery. Also, there is a need to research survey research methodology with school counselors. Therefore, this study sought to investigate the directional relationship of these constructs as measured by the aforementioned instruments. Additionally, this study examined survey methodology with practicing school counselors.

CHAPTER TWO: REVIEW OF THE LITERATURE

Introduction

Chapter two reviews the theoretical background and supporting research for the constructs of interest in this investigation, which includes school counselors': (a) self-efficacy, (b) professional quality of life, and (c) programmatic service delivery. The literature review begins with an introduction to social-learning theory, focusing on the theoretical ground and research relating to self-efficacy (e.g., social cognitive theory; Bandura, 1986, 1997; Rotter, 1954). Next, the literature review presents the theoretical underpinning regarding *professional quality of life* (e.g., compassion satisfaction, burnout, and compassion fatigue); including pertinent empirical research. The chapter continues with a brief historical review of the school counseling profession, focusing on the professional roles, responsibilities, and standards. Moreover, research on school counselors' service delivery is reviewed. In addition, the chapter outlines the theoretical and logical connection between these three constructs of interest to support the merit of the study. In conclusion, the chapter reviews literature on survey research methodology.

Social Cognitive Theory

Social cognitive theory (SCT; Bandura, 1977b), originally called *social learning theory* (SLT), was a derivative of social-cognitive-development theory postulated by Miller and Dollard (1941). In SLT's earliest form, it brought together reinforcement theories (or stimulus-response theories) and cognitive theories (Rotter, 1954, 1982). Moreover, Rotter described SLT as using both a process and content to explain personality. Miller and Dollard (1941) define learning theory as "the study of the circumstances under which a response and a cue simultaneously

become connected” (p. 1). Miller and Dollard continue to advocate that once the response and cue are connected, any appearance of the cue evokes a response (Miller & Dollard, 1941). These scholars suggested that learning is a *social* engagement that uses the processes of imitation to learn new behavior. They define imitation as “a process by which ‘matched,’ or similar, acts are evoked in two people and connected to appropriate cues” (Miller & Dollard, 1941, p. 10). That is, an individual witnesses or is exposed to the behavior of another persona and connects it to a cue, which is later modeled independently. In addition, Miller and Dollard state that the four fundamental aspects of learning are: (a) *Drive* – Motivation to learn, (b) *Response* – Action taken to learn, (c) *Cues* – Learned indicator for responses, and (d) *Reward* – Benefit or payoff for the response (Miller & Dollard, 1941).

SLT was developed and applied to clinical psychology in Rotter’s *Social Learning and Clinical Psychology* (1954). Rotter’s approach to social learning was a focus on personality development and clinical methods to work with clients. However, Bandura and Walters (1963) returned to and expanded upon Miller and Dollard’s (1941) work with the goal of formulating a theory that brings to light the influence of social interactions in the cognitive processes of learning. Initially, Bandura and Walters (1963) described social learning as an approach to *personality* (e.g., drive stimulation/reduction) that held a strong emphasis on imitation and modeling as a key learning process. However, later on Bandura (1977) moved away from learning and development as *solely* a product of *drive reduction* and placed more emphasis on *expectancies* and various *cognitive variables* (Rotter, 1982). SL as described by Rotter (1982) differs from Bandura’s (1977) SCT in that it attempts to describe stable and general aspects of *personality*, as where SCT does *not*.

Specifically, SCT (Bandura, 1977a) is a theory of learning that attributes cognitive development to be an interactional process between a learner and their environment, taking in consideration that an individual's cognitive processes are active in the development of reality as a result of the assimilation of information. In addition, SCT suggests that learning occurs as a result of observing others in social interactions, personal experiences, and other forms of contact (Bandura, 1977b; 1997). Moreover, cognition serves as a decision-making structure that incorporates the values, expectations, and experiences of an individual as they take action (Bandura, 1977b; 1986).

SCT (Bandura 1986; 1989) proposes that humans are neither self-governing nor mechanistic in relation to their environmental interaction. Instead, people are self-regulating beings that make decisions regarding actions and motivation as a result of *triadic reciprocal causation* (Bandura, 1989). Triadic reciprocal causation refers to the equal and mutual influence of *personal factors* (cognitive, affective, and biological), *environment*, and *behavior* on the decision making process (Bandura 1986; 1989). In triadic reciprocal causation, human action is a product of an interaction of personal factors, environment, and behavior. As a result, SCT advocates that the actions an individual takes incorporate self-generated stimulus as a persuading reason (Bandura, 1989). An additional mechanism of action is self-efficacy (Bandura, 1997).

Self-Efficacy

Self-efficacy is an important catalyst for an individual to take action (Bandura, 1989). Bandura (1995) defines perceived self-efficacy as “beliefs in one's capabilities to organize and execute the courses of action required to manage prospective situations” (p. 2). That is, self-efficacy is the belief individuals hold in relationship to their ability to accomplish, complete, or finish a set tasks or goals (Bandura, 1997). Beliefs regarding self-efficacy impact motivation,

affect, and agency towards events, tasks, or goals (Bandura, 1997). The theorized cause of self-efficacy includes complex and diverse sources, including positive mastery experience, vicarious experiences (e.g., observational learning) that compare an individual's ability to another person, and social influences (e.g., verbal persuasion; media, peers, authority figures; Bandura, 1989, 1995, 1997). Of these sources for self-efficacy development, positive mastery experiences are the most effective method of developing mastery (Bandura, 1995).

Efficacy influences an individual's thoughts in ways that support or hinder performance. Furthermore, the actions individuals' takes are affected by their thoughts (Bandura, 1997). As a result, individuals' thought and developed cognitive processes guide the development of their proficiency (Bandura, 1986). A function of individuals' thought is to enable forethought, which aids them in predicting outcomes and decision-making regarding what actions one should take (Bandura, 1997). Explicitly, self-efficacy regulates and influences the actions of an individual through four efficacy-activated processes, including: (a) Cognitive Processes, (b) Motivational Processes, (c) Affective Processes, and (d) Selection Processes. Subsequently, these four efficacy-activated processes are described next.

Cognitive processes. Cognitive processes relate to the thoughts and decision-making an individual undergoes when facing a stimulus or cue (Bandura, 1997). The intentionality of human behavior requires a sense of forethought, which, is based on personal goals. The development of goals results from individuals' beliefs of their ability. Therefore, humans take actions based on their goals and their perception of the likelihood of accomplishing the said goal (Bandura, 1995). Stated differently, goal setting is impacted by an individual's self-efficacy regarding the successful completion of the goal. Additionally, thought provides the ability for individuals to predict events; therefore, develop means to control their actions (Bandura, 1995,

1997). Foresight, which results in construction and rehearsal of future activities, is impacted by efficacy beliefs. In demanding situations, the ability of individuals to remain on task is supported or weakened by their efficacy beliefs. Conversely, individuals with strengthened confidence exhibit resilience when encountering demanding and taxing situations (Bandura, 1997).

Motivation processes. The concept of motivation includes one's level of desire to pursue a task or goal (Bandura, 1997). SCT proposes that motivation is a cognitive process, which is susceptible to influence from confidence (Bandura, 1997). Self-efficacy determines motivational levels in regards to level of effort towards a goal and resilience in the face of challenges (Bandura, 1989, 1997). The exercise of forethought produces anticipatory response and decision-making. Therefore, if individuals' feels an activity may *not* be a good experience, their motivation to partake in the activity might be hindered. As a result, people may avoid tasks that they are unmotivated to perform.

Affect processes. Affective processes include an individual's the emotional experiences (e.g., joy, stress, and anger). The confidence individuals have regarding their ability to cope or handle stressors may play a role in emotional arousal. For example, individuals with poor efficacy may focus more on their inadequacy or inability to overcome feelings, tasks, or situations, which results in distress (Bandura, 1989; Lazarus & Folkman, 1984). The amount or frequency of negative thoughts regarding coping skills is *not* the issue, but instead, negative thought relates to the confidence one has in reacting to their thoughts. That is, the strength in individuals' efficacy regarding affective process is related to their ability to recover from stressors or anxiety (Bandura, 1989, 1997)

Selection processes. SCT proposed that selection processes represent the idea that people have some authority of their lives through the selection and manipulation of their environments

(Bandura, 1989). People may avoid (e.g., select different environments) circumstances or tasks that they perceived to be outside of their range of ability (Bandura, 1989), resulting from the lack of confidence in their ability to be successful in the task or context. Conversely, individuals make be more involved in tasks for which they have higher levels of self-efficacy (Bandura, 1997).

School Counselor Self-Efficacy

Counseling is a complex interplay of processes, which involve the integration of skill, knowledge, self/other awareness, and intuition (Young, 2013). Moreover, counseling expects the integration of these processes to occurs quickly, timely, and with efficacious. Self-efficacy involves “a generative capability in which component cognitive, social, and behavioral skills must be organized into integrated courses of action to serve innumerable purposes (Bandura, 1982, p. 122). As such, self-efficacy is a resource to conceptualize counselor’s abilities to accomplish key tasks in counselor training, development, and evaluation (Larson & Daniels, 1998). School counselors strive to be effective practitioners (American School Counselor Association [ASCA], 2010, 2012); therefore, perceived self-efficacy can measure one’s perceptions regarding the execution of key activities.

It is the responsibility of school counselors to learn, develop, and maintain their counseling abilities (American Counseling Association [ACA], 2005; ASCA, 2010). Furthermore, counselor educators have a responsibility to foster the learning and development of these skills (ACA, 2005). Additionally, counselor educators are expected to measure student-learning outcomes as a result of their training programs (Council for Accreditation of Counseling and Educational Related Programs [CACREP], 2009). With the need for counselors to maintain their counseling skill and the increased need for counselor educations to account for skill

development in trainees, the measure of self-efficacy may be an appropriate measure that can aid in assessing and promoting school counselor development. The following section reviews the empirical research on self-efficacy as it related to the counseling and the school counseling professions.

Empirical Research on Self-Efficacy

The focus of this section is on research regarding self-efficacy in the counseling and school counseling professions. Self-efficacy “is the conviction that one can successfully execute the behavior required to produce the outcome” (Bandura, 1977, p. 79). Therefore, it may be inferred school counselors’ self-efficacy relates to their job performance. Stajkovic and Luthans (1998) conducted a meta-analysis of 117 studies ($k = 157, N = 21,616$) on self-efficacy in relation to work performance, concluding that self-efficacy is correlated (significant weighted average correlation of $G[r_+] = .38$) to work performance based on completion of tasks and job productivity. Additionally, Peterson, Luthans, Avolio, Walumbwa, and Zhang (2011) found that over time (e.g., a longitudinal study of psychological capital) employees’ self-efficacy is a contributor to work-related performance. Peterson and colleagues suggested that ongoing promotion of self-efficacy as a tool to support enhanced work performance. These studies focused on self-efficacy influence on work performance. As a result, this study sought to examine the contribution of school counselors’ self-efficacy on their programmatic service delivery (i.e., job related task).

Self-efficacy relates to the confidence regarding one’s ability to be successful in a specific task or goal (Bandura, 1997). Therefore, individuals’ confidence is related to their wellness (or burnout). Gündüz (2012) examined the relationship between self-efficacy and burnout in 194 school counselors in Mersin, Turkey. The researcher used the *Maslach Burnout*

Inventory (MBI; Maslach & Jackson, 1986) and the *School Counselors Self-Efficacy Scale* (Yiyit, 2001), identifying that self-efficacy had a negative relationship between emotional exhaustion and depersonalization. In addition, they reported a positive relationship between personal accomplishment and self-efficacy. Gündüz (2012) identified that social support was positively correlated to higher levels of self-efficacy but did *not* report the correlation coefficient (or any other results) in their article. The results Gündüz's (2012) described support the need to further explore the influence of self-efficacy on school counselors' wellness because there is an apparent, yet unclear, positive relationship between the constructs. However, these results should be interpreted with caution because the author did *not* report the statistical results; rather, the researcher only reported a description of the results. In addition, the study was conducted in Turkey, which limits its generalizability to the population being used in this study. This study supports the existence of a relationship between self-efficacy and factors of burnout in school counselors.

Sutton and Fall (1995) surveyed school counselors ($N = 316$) regarding school climate and self-efficacy. Their study involved the development of a scale to measure counselors' self-efficacy based on outcome expectancy and efficacy expectation. Also, they created the school climate scale to measure contextual factors related to the work environment of school counselors. Specifically, they mailed questionnaires to 383 school counselors in the state of Maine, with a response rate of 83% ($N = 316$). These authors found that staff ($\beta = .20, p < .05$) and administrator support ($\beta = .23, p < .05$) was the strongest predictor of increased self-efficacy $F(12,197) = 3.03, p < .001$. Moreover, support from administrators ($\beta = -.22, p < .01$) and staff ($\beta = -.34, p < .001$) and limited non-counseling duties ($\beta = .54, p < .05$) were predictive of higher outcome expectancy, $F(12,197) = 6.77, p < .001$. Consequentially, the work place environment

and assign duties related to school counselors' self-efficacy. Sutton and Fall (1995) did *not* examine the impact of the respondents self-efficacy on their work wellbeing and service delivery. Future research is warranted that examines how the efficacy beliefs influence the services school counselors provide.

Owens, Bodenhorn, and Bryant (2010) examined the relationship between school counselors' ($N = 157$) self-efficacy and their multicultural competency. They found that *cultural acceptance*, as measured by a subscale on the *School Counselor Self-Efficacy Scale* (SCSEs; Bodenhorn & Skaggs, 2005), was predictive of multicultural competence, $F(3,118) = 10.64, p < .01$, as measured by the *Multicultural Competency Scale* subscales (MCC; Holcomb-McCoy & Day Vines, 2004). The results from the study supported the importance of self-efficacy in relationship to essential school counselor functions, as shown in its predictive ability regarding multicultural competence. Therefore, research is needed to further explore the influence of school counselors' self-efficacy on other significant counselor qualities (e.g., service delivery and professional quality of life).

Bodenhorn, Wolfe, and Airen (2010) surveyed a national sample of school counselors (e.g., members of the ASCA; $N = 860$) to examine the relationship between their self-efficacy, type of program, status of achievement gap, and equity in their school. A random sample of 1,600 ASCA members were sent a packet of questionnaires either through email (electronically) or mailed a paper-pencil version using *Tailored Design Method* (Dillman, Smyth, & Christenson, 2009). The response rate for those participants receiving postal mail was 41% and 77% for those receiving electronic invitations (total of 54% response). Of the participants who completed the survey, 85% ($n = 721$) were female and 15% ($n = 139$) were male. In addition, the authors reported that 89% ($n = 756$) were European American, 5% ($n = 45$) African American, 2%

Hispanic American/Hispanic, 1% ($n = 6$) Asian American, 1% ($n = 6$) Native American, and 2% ($n = 16$) multiracial, and 2% ($n = 14$) did *not* report ethnicity. The authors used several instruments, including: (a) SCSEs (Cronbach's alpha = .97), (b) six questions assessing achievement gap status (no Cronbach's alpha reported), (c) four questions assessing school equity (Cronbach's alphas = .77), (d) seven questions inquiring about program approach.

Bodenhorn and colleagues (2010) examined two research questions that involved self-efficacy. First, they sought to see if self-efficacy has a relationship with their perception of achievement gap status and equity in the school. They used a bivariate regression to examine the relationship between SCSES and equity, which resulted in significant results $F(1,847) = 104.70$, $p < .001$, $R^2_{adj} = .11$, identifying a medium to large effect size (e.g., $r = .33$). These results indicate that as school counselors' self-efficacy increases their perceptions of equality also increase. In addition, the authors used a logistical regression to use SCSES (continuous) as a predictor variable of perceived achievement gap (categorical). They simplify the analysis by breaking the scores of the SCSES into quartiles and found significant results, $X^2(6) = 25.52$, $p = .0003$, $R^2 = .01$. Specifically, the results identified that school counselors with higher self-efficacy were more aware of the achievement gap than counselors with lower self-efficacy. Again, school counselors' self-efficacy was related to their counselor tasks, providing merit to examine the influence of self-efficacy on counselors' service delivery.

Bodenhorn and colleagues (2010) also used a logistical regression, which identified a relationship between self-efficacy and school counseling program approach, $X^2(3) = 33.69$, $p = .0001$, $R^2 = .02$. The authors placed the SCSES scores in quartiles to make the analysis simpler. The results indicated that school counselors with higher self-efficacy were more likely to implement the ASCA *National Model* as their school counseling program approach. Participants

with lower self-efficacy were more likely to report using a comprehensive guidance curriculum ($X^2 [1] = 3.91, p = .05$). Thus, counselors' self-efficacy relations to their choice of service delivery. Another noteworthy finding is that 10% ($n = 87$) of the participants indicated that they do *not* use any acknowledged framework for implementation of a school counseling program. Therefore, self-efficacy in school counseling tasks may aid in role clarity. This study examined the relationship between school counselors' self-efficacy and their implementation of service activities.

Bodenhorn and colleagues (2010) identified relationships between school counselors' self-efficacy and other importance counselor variables; however, the study included limitations. The study participants consisted of ASCA member, which excludes anyone who is *not* a member of ASCA (limited generalizability). In addition, the study relied on participant self-report, which may require other forms of measurement to confirm their answers (Gall, Gall & Borg, 2007). Another limitation includes the limited reliability and validity of the three of the four instruments used. Specifically, the constructs program approach, perceived achievement gap and equity in the school were all measured by researcher-designed constructs that have limited testing. This study supported the need to continue exploring how self-efficacy relates to the behaviors of school counselors. Specifically, this study found that higher levels of self-efficacy are related to school counseling program approach. Thus, more research examining the influence of school counselors' self-efficacy on their professional quality of life and service delivery practices is warranted.

Clark (2006) conducted a study that examined the relationship between the use of the ASCA *National Model* and school counselor self-efficacy. The participants for this study consisted of 110 (10.43% response rate) school counselors in the state of Alabama, who

completed a survey online after an email invitation. The participants consisted of 46 elementary school counselors, 7 middle/junior high school counselors, and 34 high school counselors. Additionally, 89.10% ($n = 98$) of the sample was female and 10.90% ($n = 12$) were male. Of these participants, 70% were Caucasian, 25.5% were Black, 1.8% were Hispanic, 0.9% were Native American, and 0.9% indicated some other form of ethnicity (note the author did *not* provide the amount but only percentage for ethnicity). The participants ranged from 26 to 68 years of age, with a mean of 44.22 ($SD = 11.17$). The author constructed and implemented the email survey following the recommendations of Dillman and colleagues (2007).

The author used three data collection instruments, including: (a) a demographics questionnaire, (b) the *School Counselor Activity Rating Scale* (SCARS; Cronbach's alpha .91; Clark, 2006), and the SCSEs (Cronbach's alpha .96). The SCARS resulted in mean score of 3.60 ($SD = .52$, $range = 2.10$ to 4.57). The SCSES resulted in a mean score of 4.14 ($SD = .53$, $range = 2.57$ to 4.98). To examine the relationship between the ASCA *National Model* and school counselor self-efficacy, the researcher analyzed the correlation of the total mean scores between the SCARS and SCSES scores. The results identified a statistically significant correlation, $r = .30$, $p < .01$. In addition, subscale scores were examined and resulted identified multiple correlations. Table one outlines the correlations between subscales mean scores.

Table 1 *Correlations between SCARS and SCSES subscales*

SCARS Subscales	SCSES Subscales				
	<i>Personal/Social</i>	<i>Leadership/ Assessment</i>	<i>Career/Academic</i>	<i>Collaboration</i>	<i>Cultural Sensitivity</i>
<i>Counseling</i>	0.29*	0.42**	0.28*	0.27*	0.33*
<i>Consultation</i>	0.28*	0.32**	0.25	0.32**	0.32**
<i>Curriculum</i>	.10	0.24	0.04	0.03	0.10
<i>Coordination</i>	0.39**	0.36**	0.24**	0.36**	0.32**
<i>Other</i>	-0.12	-0.05	-0.07	0.13	-0.00

Correlation is significant at 0.01 (two-tailed). ** Correlation is significant at 0.05 (two-tailed).

Note. This table was adapted from Clark, 2006.

In addition to examining correlations, Clark (2006) examined the extent to which school counselor self-efficacy varies in accordance with perceived understanding of the *ASCA National Model*, employing a stepwise multiple regression with the SCSES as the dependent variable and some questions from the demographics questionnaire as the predictor variables. The author found that the reported greater the understanding of the *ASCA National Model* predicted higher levels of reported self-efficacy, $F(1,108) = 21.53, p < .01, R^2 = .17$. Thus, the results identified that counselors with more familiarity with the *ASCA National Model* had higher self-efficacy scores were regarding their work as a counselor. While Clark' (2006) study provides promising results, several limitations were presented. The author used a single state for the sample, which excludes most of the country. In addition, the author achieved a small response rate, which may lead to results to be impacted by non-response bias. Another limitation is the limited depth of the statistical analysis used and small effect sizes on some of the correlations. Nonetheless, Clark's results supported the relationship between the constructs of school counselor service delivery (e.g., SCARS) and school counselor self-efficacy (e.g., SCSES).

Professional Quality of Life

This next section of Chapter Two reviews the theoretical tenets of *professional quality of life* as it relates to counseling and school counseling professions. Professional quality of life consists of multiple constructs, including: *Compassion Satisfaction*, *Burnout*, and *Compassion Fatigue*. In addition, the connection between counselors' professional quality of life, self-efficacy, and service delivery is presented.

Quality of Life

The concept quality of life has many definitions that vary depending on the scholars (Felce & Perry, 1995). Researchers have used population-wide social indicators as aggregated

indicators of general wellbeing (e.g., Baernholdt, Hinton, Yan, Rose, & Mattos, 2012; Bonomi, Patrick, Bushnell, & Martin, 2000). In addition, researchers use social and psychological indicators at the individual level (e.g., Bigelow, McFarland, & Olson, 1991). However, the term quality of life relates to wellbeing of individuals and the general population (Nussbaum & Sen, 1993). Quality of life is both descriptive and evaluative (Sirgy, Michalos, Ferriss, Easterlin, Pavot, & Patrick, 2006). Specifically, quality of life can describe and evaluate an individual's or a society's quality of living circumstances (e.g., *descriptive* – describes the person's life quality; *evaluative* – places an evaluation on the person's life quality).

As noted, many definitions regarding quality of life exist. However, two commonly used definitions are Felce and Perry's (1995) and World Health Organization's versions (WHO; 1998). Felce and Perry (1995), after a comprehensive review of the literature, define *quality of life* as “an overall general wellbeing that comprises objective descriptors and subjective evaluations of physical, material, social, and emotional wellbeing together with the extent of personal development and purposeful activity, all weighted by a personal set of values” (pp. 60-62). The WHO (1998) defines *quality of life* as “individuals' perceptions of their position in life in the context of the culture and value systems in which they live and in relation to their goals, expectations, standards and concerns” (p. 2). In addition, the WHO (1998) states their definition of quality of life “is a broad ranging concept incorporating in a complex way the persons' physical health, psychological state, level of independence, social relationships, personal beliefs and their relationships to salient features of the environment” (p. 2). Quality of life is a mechanism in which researchers can explore systemic, cultural, and contextual outcome differences with the goal of improving life for a given population (Sirgy et al., 2006). The following section describes professional quality of life.

Professional Quality of Life

Quality of life has many definitions whereas professional quality of life is a newer concept that has limited clarification. The construct of professional quality of life is derived from the development and enhancement of the *Compassion Fatigue Self-Test* (CFST; Figley, 1995; Stamm, 2005). As researchers tested and revised the CFST, they found the instrument measured constructs related to positive system change (Stamm, 2005). Thus, once the CFST was tested and developed, the labeling of the identified constructs changes to more accurately represent the positive and negative aspects of the professional life. The refinement of the CFST resulted in the constructs (in the form of subscales) of compassion satisfaction, compassion fatigue, and burnout. As a result, professional quality of life represents *how an individual feels in relation to their work as a helper* (Stamm, 2010). The feelings associated with quality of life are influenced by both the positive experiences (e.g., satisfaction, altruism, and fulfillment) and negative experiences (e.g., frustration, emotional turmoil, stress).

School counselors become connected to their work and the students they serve (Kottler, 2010). Many counselors enter the profession as the result of feeling called to help students (Ribak-Rosenthal, 1994). In addition, counselors-in-training may have aspired to become a school counselor as a direct result of the experiences they had with their own school counselor. As such, helping students or helping others may be a chief motivator for become a school counselor (Kottle, 2010). Compassion is defined as an awareness of the duress of others and the desire to help them alleviate or overcome it (Marriam-Webster Online Dictionary, n.d.). As such, school counselors are often guided by compassion and a sense to help the development of the students at their school. Professional quality of life relates to compassion as experienced through one's work (Stamm, 2010).

Professional quality of life can be broken down into two specific constructs: (a) *Compassion Satisfaction* (positive components) and (b) *Compassion Fatigue* (negative components; Stamm, 2010). Additionally, compassion fatigue breaks into two distinct parts, including: (a) *Burnout* and (b) *Secondary Traumatic Stress*. Figure one presents a graphical representation of professional quality of life and its related constructs.

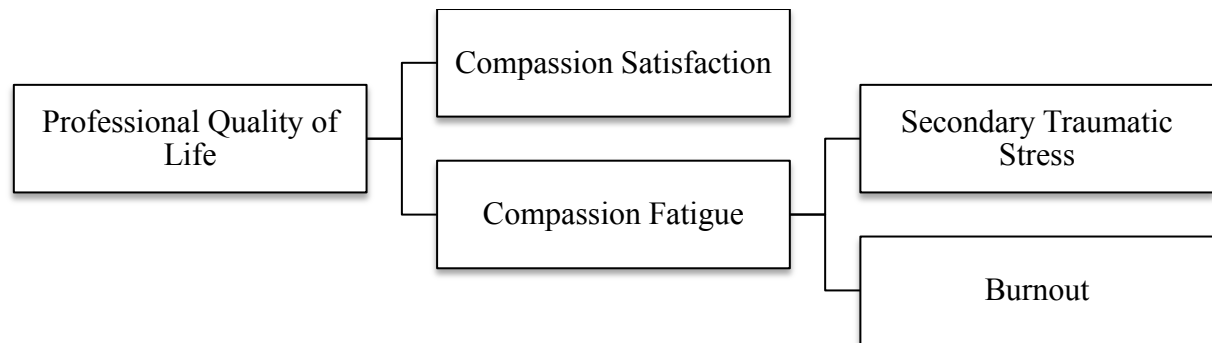

Note. Adapted from Stamm, 2010

Figure 5: Diagram of Professional Quality of Life

Compassion Satisfaction

Much of the research on the wellbeing of school counselors has a focus on the negative aspects of the job such as burnout (e.g., Butler & Constantine, 2005; Lambie, 2007; Limberg, 2013). Counselors' work environment is destined to result in fatigue and stress (Kottler & Hazler, 1996; Norcross & Guy, 2009; Skovholt & Trotter-Mathison, 2010); however, research also identifies positive aspects of work as a counselor (e.g., Lawson, 2007; Lawson & Meyers, 2011). Some helping professionals do *not* have negative experiences in their interactions with clients/students and maintain their vigor for their work (Bride, Radey, & Figley, 2007).

Unfortunately, limited research is published regarding how positive experiences in the helping profession impact counselors (Linley & Joseph, 2007).

Stamm (2010) describes compassion satisfaction as “the pleasure you derive from being able to do your work well” (p. 12). The positive feelings in compassion satisfaction result from colleague support, contributing to the work setting, and aiding society in general (Cicognani, Pietrantonio, Palestini, & Prati, 2009). Compassion satisfaction is similar to altruism, which is the “behavior motivated by the concern for others or by internalized values, goals, and self-rewards rather than by the expectation of concrete or social rewards, or the desire to avoid punishment or sanctions” (Eisenberg, Guthrie, Murphy, Shepard, Cumberland, & Carlo, 1999, p. 1360). However, compassion satisfaction is related to the outcome of one’s work rather than the motivation to do the work (i.e., *altruism* – motivated by the concern for others; Stamm, 2010). Satisfaction in one’s work (i.e., compassion satisfaction) is important with consideration to job retention (Tillman, 2013), positive life satisfaction (Lent, Nota, Soresi, Ginevra, Duffy, & Brown, 2011), implementation of school counseling programming (Pyne, 2011), lower levels of burnout (Lee, Cho, Kissinger, & Ogle, 2010), and positive subjective-wellbeing (Bowling, Eschleman, & Wang, 2010), necessitating further investigation.

Protective factors exist that support the experience of compassion satisfaction (Phelps, Lloyd, Creamer, & Forbes, 2009). Spiritual wellbeing (Kim & Seidlitzm 2002; Norcross & Guy, 2009), capacity for empathy (Figley, 2002), organizational support (Collings & Long, 2003), and social support (Hesse, 2002) are all examples of protective factors that may support counselors’ wellness. Additional career sustaining behaviors include time with family, sense of humor, work-personal life balance, and self-awareness (Lawson & Meyers, 2011). The formation of resilience is an active process in which the counselor must engage in behaviors that foster wellbeing (Skovholt & Trotter-Mathison, 2010).

Compassion Fatigue

Working as a helping professional is rich with challenging experiences (Kottler, 2010). Compassion fatigue was recognized in the 1990's (e.g., Joinson, 1992). The construct of compassion fatigue results from an exposure to job-related events that are stress ending (Figley, 1995). Radey and Figley (2007) suggested compassion fatigue develops from the witness of client suffering and limited support at home and in the workplace. A counselor's exposure to traumatic circumstances and limited support to resolve the experience results in his or her deteriorated capability to be present with clients/students and feelings of inability and confusion (Figley, 2002). Counselors who are impaired are more likely to harm clients' as compared to non-impaired counselors (Lawson, Venart, Hazler, & Kottler, 2007). Moreover, Stamm (2010) suggested that compassion fatigue is the result of two specific components, which include: (a) Secondary Traumatic Stress and (b) Burnout.

Secondary traumatic stress. Secondary traumatic stress was first defined as an emotional duress that results from close contact with an individual who has experienced a trauma (Figley, 1983, 1995; Figley & Kleber, 1995; Stamm, 2010). Secondary traumatic stress is considered an occupational hazard as a result of its breadth across professions and prevalence (Bride, Hatcher, & Humble, 2009). Symptomology of secondary traumatic stress includes similar indicators as Post Traumatic Stress Syndrome (Jenkins & Baird, 2002). However, secondary traumatic stress results from the *helper's experiences* of stress as the results of hearing the client (or student) describe their struggle. For example, if clients/students describes an abuse situation, the counselor may then form anxiety or stress as the result of hearing it, impacting his or her thinking about the clients'/students' experience outside of the counselor's work with him or her. Additionally, helping professionals may experience symptoms of secondary traumatic stress such as sleep related difficulties, fear regarding the experience, intrusive images related to the

experience, persistent arousal, and avoidance of anything that is related to the client's issues (e.g., paperwork, professional development, movies; Figley, 1995; Stamm, 1995).

Figley (1995) renamed secondary traumatic stress to *compassion fatigue* as a result of the potential stigmatizing of mental health care workers due to its commonality in helping professions. Therefore, the name changes to compassion fatigue served to normalize the perception of compassion fatigue. Figley (1995) emphasizes that secondary traumatic stress is synonymous with compassion fatigue; however, Stamm (2005, 2010) argues that secondary traumatic stress is a single component of compassion fatigue. Stamm (1995, 2005, 2010) states that burnout is a second component of compassion fatigue. That is, secondary traumatic stress's impact on the helpers' outlook results in burnout (Stamm, 1995, 2005, 2010), which results in compassion fatigue have two dimensions.

Burnout. The concept of burnout is researched (Limberg, 2013; Maslach, 2003). Two influential contributors to the current knowledge on burnout include Freudenberger (1974) and Maslach (1978, 2003). Burnout is a mental and physical exhaustion that causes a negative outlook and interest in one's job, which may lead to diminished services for the clients being served (Freudenberger, 1978, 1989; Maslach, 2003). Moreover, Maslach (2003) asserts that burnout consist of three factors, including: (a) emotional exhaustion, (b) depersonalization, and (c) reduced personal accomplishment. Burnout may result in reduced quality of care provided by helping professionals (Poghosyan, Clarke, Finlayson, & Aiken, 2010). Also, burnout can result in dissatisfied work experiences and increased level of negative impressions (DeVoe, Fryer, Hargraves, Phillips, & Green, 2002; Soderfeldt, Soderfelt, & Warg, 1995).

Helping professionals who are impaired function with limited confidence and competence (Kottler & Hazler, 1996; Maslach, 2003; Norcross & Guy, 2007; Skovholt &

Trotter-Mathison, 2011). Furthermore, burnout is common amongst helping professionals (Kottler & Hazler, 1996; Norcross & Guy, 2007). Symptoms of burnout include negative: (a) attitudes, (b) mental and emotional state, (c) behavioral state, (d) motivation, (e) physical state (Freudenberger, 1989; Maslach, 2003). The symptomology results in an impairment of personal and professional functioning (Maslach, 2003). Fortunately, the topic of burnout in the counseling profession is researched (e.g., Butler & Constatine, 2005; Lambie, 2007; Limberg, 2013; Moyer, 2011; Wilkerson, 2009; Wilkerson & Belinki, 2006).

Empirical Research on Professional Quality of Life Factors

There is limited research investigating school counselors' professional quality of life; nevertheless, research from related fields is reviewed along with specific counseling and counseling related literature on this topic. Craig and Sprang (2010) examined the relationship between the use of evidence-based practices and its effect on compassion fatigue, compassion satisfaction, and burnout. They conducted the study with 532 mental health professionals who work with trauma inflicted clients. They used the *Professional Quality of Life scale* (ProQOLs; Stamm, 2005) along with the *Trauma Practices Questionnaire* (Craig & Sprang, 2009). They found that among their participants, younger participants reported greater burnout and more experienced participants reported higher levels of satisfaction. Also, they found that the use of evidenced-based practices predicted decreases in burnout and fatigue. Conversely, the use of evidenced-based practices has shown increase in compassion satisfaction. This study provides insight into the impact of evidenced based practice on professional quality of life. However, some study limitations included: (a) a low response rate (e.g., 27.1%), (b) limited generalizability as a result of participants being member in professional association, and (c) the authors noted flaws in the *Trauma Practices Questionnaire*. Nevertheless, this study supported the need to

explore the relationships between service delivery (e.g., evidenced-based practices) and professional quality of life.

Lawson (2007) investigated wellness and impairment of ACA members who were practicing counselors. Specifically, the author surveyed 1,000 ACA members following *Tailored Design Method* (2007), resulting in a 50.9% response rate ($N = 501$). The author used three instruments: (a) a demographics questionnaire, (b) the *Career-Sustaining Behaviors Questionnaire* (CSBQ; Stevanovic & Rupert, 2004), and (c) the ProQOLs (Stamm, 2005). The participants included 77.6% ($n = 388$) female, 21.2% ($n = 106$), and 1.2% ($n = 6$). Of the respondents, 71.8% ($n = 359$) identified as White Caucasian, 4.8% ($n = 24$) identified as African American, 2.2% ($n = 11$) identified as Hispanic, 1.2% ($n = 3$) identified as Native American or Alaskan Native, 0.8% ($n = 4$) identified as Native Hawaiian or other Pacific Islander, and 0.6% ($n = 3$) identified as Asian. The mean age of the participants was 48.8 ($SD = 11.23$), including an average of 12.3 years of experience. Participants reported working in a variety of settings, including: (a) private practice (42.6%; $n = 197$); (b) community agency setting (22.5%; $n = 104$); (c) K-12 educational setting (19%; $n = 88$); (d) college or university (9.3%; $n = 43$); (e) hospital or residential setting (5.6%; $n = 26$); and (e) other setting (0.9%; $n = 4$).

The ProQOL was selected to measure respondents' compassion satisfaction, compassion fatigue, and burnout (Lawson, 2007). The respondents reported a mean score of 39.84 ($SD = 6.43$, $\alpha = .77$) on the compassion satisfaction scale, a mean score of 18.37 ($SD = 6.0$, $\alpha = .82$) on the burnout scale, and a mean score of 10.05 ($SD = 5.91$, $\alpha = .85$) on the compassion fatigue scale. As compared to the nationally normed scores, these participants scored statistically significantly lower in fatigue (e.g., $M = 13$, $SD = 6.3$, $\alpha = .80$; $t(942) = 7.47$, $p < .05$, $d = -.48$) and burnout (e.g., $M = 22$, $SD = 6.8$, $\alpha = .71$; $t(950) = 9.1$, $p < .05$, $d = -.57$) and statistically

significantly higher in satisfaction (e.g., $M = 37$, $SD = 7.3$, $\alpha = .89$; $t(950) = 6.54$ $p < .05$, $d = .41$). In addition, those participants who work as counselors in K-12 settings reported lower scores on the burnout scale ($M = 19.70$, $SD = 6.29$, $d = -.64$) as compared to participants in private practice ($M = 15.77$, $SD = 6.04$, $d = -.63$) but higher than the respondents in a community setting ($M = 19.85$, $SD = 6.88$, $d = -.63$), $F(5, 456) = 8.22$, $p = .000$. Furthermore, respondents that work as counselors in K-12 settings higher on compassion fatigue scale ($M = 11.89$, $SD = 6.40$, $d = -.62$) than participants in community settings ($M = 10.31$, $SD = 5.78$, $d = -.37$) and private practice ($M = 8.26$, $SD = 5.25$, $d = -.64$), $F(5, 456) = 5.72$, $p < .035$. However, the results of this study should be interpreted with caution as a result of its limitations, including: (a) limited diversity in sampling and (b) the self-report nature of the study. Nevertheless, this study's findings supported the need for further investigation into school counselors (e.g., counselors in K-12 settings) professional quality of life. Specifically, the findings identified that school counselors have unique responses regarding professional quality of life as compared to other counseling professionals. Therefore, this study examined how school counselors reported professional quality of life contributed to their service delivery.

Sprang, Clark, and Whitt-Woosley (2007) examined the relationships between compassion fatigue, compassion satisfaction, and burnout, including setting characteristics. Their study they surveyed 6,720 helping professional (e.g., psychologist, counselors, social workers, family therapist, and addiction counselors) respondents that resulted in 1,121 participants (19.5% response rate). Specifically, they surveyed licensed or certified behavioral health providers (e.g., counselors, social workers, and marriage and family therapists) in a single rural state in southern United States (U.S.). The authors used paper-pencil mailing survey, which included the following instruments: (a) a detailed demographics questionnaire and (b) the ProQOLs (Stamm,

2005). The demographics questionnaire included a series of scale items that identifies personal and professional characteristics. The participant's average age was 45.22 years ($SD = 10.84$, range = 23 to 81). Regarding gender, 69.6% ($n = 749$) were female and 30.4% ($n = 327$) were male. The participants had on average 13.92 years of experience ($SD = 9.54$). The participants reported their highest earned degree; with 68.6% holding a Masters degree (no other degree statistics were reported). Of the participants, 35.8% worked in community mental health settings, 13.6% worked in public agencies, 29.6% worked in private practice, 6.2% worked in inpatient facilities, 4.9% worked in private facilities, and 9.9% work in other settings (authors did *not* provide n 's). The authors did *not* report ethnicity.

The authors reviewed the mean scores on the ProQOL (Sprang et al., 2007), including: (a) Compassion Fatigue – 10.64, (b) Compassion Satisfaction – *not reported*, (c) Burnout – 19.9 (author *did not* report standard deviations). Compassion fatigue and burnout were lower when compared to the national norm average of 13 and 23 respectively. In addition, the researchers analyzed burnout, compassion satisfaction, and compassion fatigue using a multivariate analysis of variance (MANOVA) using gender as a grouping variable. The results of this comparison indicated statistically significant differences between these variables, $F(3, 1054) = 7.10, p < .001$ ($\eta^2 = .02$, power = .98). The findings identified that female participants had higher scores on compassion fatigue and burnout than their male counterparts.

Next, the authors conducted a MANOVA to examine the mean score differences between burnout, compassion satisfaction, and compassion fatigue using highest degree earned. The resulting MANOVA identified significant differences between groups, $F(9, 771) = 2.56, p < .01$ ($\eta^2 = .03$, power = .94). Participants who reported holding a Medical Doctorate (MD) reported higher levels of compassion fatigue as compared to participants who reported holding a master's

degree or Doctorate of Philosophy, indicating that entry-level counselors (i.e., Masters level) report less negative side effects of their work as compared to medical doctors. Potentially, Sprang and colleagues' findings support that higher degree levels may negatively impact professional quality of life and the results may support that the training practices of entry-level counselor prepare practitioners who are more focused on self-care.

Sprang and colleagues (2007) produced an up-close examination of compassion satisfaction, compassion fatigue, and burnout as compared to some demographic variables. Sprang and colleagues found that gender, age, licensure, location, degree level, clinical experience, and percentage of trauma work *all* influence levels of compassion satisfaction, compassion fatigue, and burnout. However, this study consists of some limitations, including: (a) small effect sizes (e.g., $\eta^2 = .02$) and (b) limited demographic reporting in the findings. Nonetheless, this study's findings supported the need to examine demographic factors as they relate to compassion satisfaction, compassion fatigue, and burnout in school counselors.

Lawson and Myers (2011) examined the wellness, professional quality of life, and career-sustaining behaviors of 1,000 professional counselors who were members of ACA using mail based surveying that following Dillman et al's (2009) *Tailored Design Method*. The researchers got a 51.7% response rate ($N = 506$). The author used four instruments: (a) a demographics questionnaire, (b) the *Career-Sustaining Behaviors Questionnaire* (CSBQ; Stevanovic & Rupert, 2004), (c) the ProQOLs (Stamm, 2005), and the Five Factor Wellness Inventory (5F-Wel; Meyers & Sweeney, 2004). The participants included 78.8% female ($n = 399$) and 21.1% male ($n = 107$). The ethnicity of the respondents was Caucasian (89.1%; $n = 451$), African American (5.5%; $n = 28$), Asian/Pacific Islander (2.6%; $n = 14$), Hispanic (1.8%; $n = 10$), and Native American (1.0%; $n = 6$). The mean age of respondents was 49.9 ($SD = 11.1$), including an

average years of experience of 13.6 ($SD = 9.4$). Participants reported working in a variety of settings, including: (a) private practice (39.3%; $n = 199$); (b) community agency setting (23.5%; $n = 119$); (c) K-12 educational setting (20.6%; $n = 105$); (d) college or university (11.7%; $n = 60$); (e) hospital or residential setting (4.9%; $n = 25$).

The ProQOL was selected to measure respondents' compassion satisfaction, compassion fatigue, and burnout (Lawson & Meyers, 2011). The respondents reported a mean score of 40.53 ($SD = 5.57$, $\alpha = .84$) on the compassion satisfaction scale, a mean score of 19.93 ($SD = 5.96$, $\alpha = .72$) on the burnout scale, and a mean score of 10.32 ($SD = 5.98$, $\alpha = .80$) on the compassion fatigue scale. As compared to the nationally normed scores, these participants scored lower in fatigue (e.g., $M = 13$, $SD = 6.3$, $\alpha = .80$; $t(967) = 6.33$, $p < .001$, $d = .44$) and burnout (e.g., $M = 22$, $SD = 6.8$, $\alpha = .71$; $t(967) = 4.73$, $p < .001$, $d = .32$) and higher in satisfaction (e.g., $M = 37$, $SD = 7.3$, $\alpha = .89$; $t(967) = 8.04$, $p < .001$, $d = .54$). In addition, those participants who work as counselors in K-12 settings reported lower scores on the burnout scale ($M = 19.98$, $SD = 6.20$) as compared to participants in private practice ($M = 17.21$, $SD = 5.17$) but higher than the respondents in a community setting ($M = 20.43$, $SD = 6.39$), $F(4, 481) = 7.28$, $p < .001$, $\eta^2 = .06$. Furthermore, respondents that work as counselors in K-12 settings higher on compassion fatigue scale ($M = 40.06$, $SD = 5.08$) than participants in community settings ($M = 38.91$, $SD = 6.64$) but lower than those respondents in private practice ($M = 42.13$, $SD = 4.46$, $d = -.64$), $F(4, 481) = 7.82$, $p < .001$, $\eta^2 = .06$. The results of this study should be interpreted with caution due to its limitations, including: (a) limited diversity in sampling and (b) the self-report nature of the study. Nevertheless, this study provides support to further investigate school counselors (e.g., counselors in K-12 settings) professional quality of life. In addition, Lawson and Myers' findings supported that school counselors report unique responses regarding burnout, compassion fatigue,

and compassion satisfaction as compared to other counseling professionals (e.g., mental health counselors).

School Counselor Service Delivery

The following section reviews relevant theory, literature, and research regarding the profession of school counseling. Specifically, this section of the chapter presents information on the following topics: (a) history, growth, and development of the school counseling profession; (b) school counselors' role and responsibilities; (c) service delivery activities; and (e) research on school counselor service delivery.

History, Growth, and Development of the School Counseling Profession

Reviewing the historical background of the school counseling profession supports in understanding contemporary school counseling practices and systematic professional influences. Initially, school counseling was termed *vocational guidance*, as the profession was a tool to aid the career transitions of the students/clients. Specifically, the vocational guidance movement came about to help people find jobs during an industrialized culture (Gysbers, 2010). The vocational guidance movement was seen as a response to the economic, social, and education problem of the time (Gysbers & Henderson, 2004). The role of early school counselors (e.g., vocational counselors) was similar to modern day career counselors. Scholars identify two purposes for the initial use of vocational counselors: (a) *social efficiency* – to aid the economy to be as efficient as possible and (b) *democratic philosophy* – to develop industrial conditions and to aid students in occupational decision-making (Schmidt, 2008). Over time, this role transitioned to become more flexible to the needs of students, the community, and society.

Throughout the development and transformation of the school counseling profession, various events played a role in the development of school counselors' role and responsibilities.

Some of these events include (a) legislative changes (e.g., *National Defense Education Act* [Schmidt, 2008]), (b) significant publications (e.g., *School Counseling: A Profession At-Risk* [Gysbers & Henderson, 2006]), (c) developments in the field (e.g., humanistic movement [Rogers, 1957]), and (e) the formation of professional associations (Gysbers & Henderson, 2006). The profession of school counseling has received attention for having an ambiguous purpose (Lambie & Williamson, 2004; Schmidt, 2008). However, ASCA has taken measures to articulate a clear and concise role for counselors (e.g., ASCA, 2012, 2013). Additionally, scholars have established a vision for developmental comprehensive school counseling programs (Gysbers & Henderson, 2006).

An important process in the development of school counselors' identity was the creation of key publications that communicate the roles, responsibilities, and standards for school counselors. These publications include (a) the ASCA (2003, 2005, 2012) *National Model*, (b) ASCA(1997, 2004) *National Standards for Students*, (c) ASCA (2012) *School Counselor Competencies*, and (d) ASCA (2013) *Position Statements*. The ASCA (2003, 2005, 2012) *National Model* provides guidelines for school counselors on how to development comprehensive school counseling programs. The ASCA *National Standards for Students* allocate the specific competencies that students should acquire through the facilitation of a school counseling program. The ASCA *School Counselor Competencies* provide an outline of the knowledge, skills, abilities, and aptitude that school counselors have that make them qualified to meet the diverse and complicated need for students. Lastly, the ASCA position statements provide an assortment of comments on topics of interest to school counselors (e.g., character education; ASCA, 2013). These ASCA publications provide an articulate and concise communication of the role school counselors have in the educational setting.

The foundation of the ASCA *National Model* (2003, 2005, 2012) was first conceptualized in position statements made by ASCA in the 1960's and has progressed overtime to encompass the growing and diverse roles of school counselors (Gysbers & Henderson, 2006). The ASCA *National Model* is a significant contributor to the advancement of the school counseling profession. Specifically, the model postulates the systemic framework that school counselors utilize in their facilitation of developmental and comprehensive school counseling programs (ASCA, 2012). The framework for comprehensive school counseling programs consist of these four components: (a) foundation, (b) management, (c), accountability (d) and delivery (ASCA, 2012). The *foundation* represents the focus on student outcomes (e.g., program focus), student competencies, and expected professional competencies. The *management* component of ASCA framework represents the organizational assessment of school needs. In addition, management includes the leadership responsibly that support the operation of the program (e.g., advisory councils, annual agreements, data, action plans, and calendar management). *Accountability* is the use of assessments and analysis to interpret the impact of the school counseling program on the student population impacted by the services. *Delivery* represents the direct services that school counselors provide to students, families and other stakeholders, including direct students services (e.g., curriculum, student planning, and responsive services) and indirect student services (e.g., consultation, coordination, and collaboration). Moreover, delivery is the component in the ASCA model that describes the counseling (individual and group) aspect of the school counselors' job.

Appropriate service delivery activities.The ASCA (2012) *National Model* articulates the responsibility of school counselors. This study examined the activities and interventions related to appropriate delivery activities, including (a) curriculum (e.g., classroom guidance), (b) counseling (e.g., individual and group), (c) consultation, and (d) collaboration (Bodenhorn,

2005). These activities are the focus of school counselor training programs (CACREP, 2009) and are identified as modalities to aid in supporting student needs (ASCA, 2012; Schmidt, 2008).

However, counselors are often unable to perform their preferred activities as a result of situational and systemic barriers (Scarborough & Culbreth, 2008). In addition, school counselors may be asked or required to partake in non-counseling related activities.

Non-counseling related service delivery activities. Regularly, school counselors engage in activities that are *not* designated by the ASCA (2012) *National Model* (Dollarhide, 2003; Scarborough & Culbreth, 2008). These non-counseling activities may include (a) substitute teaching, (b) clerical work, (c) discipline, (d) hall/bus duty, (e) medical issues, and (f) course scheduling (e.g., Gysbers & Henderson, 2006; Lambie & Williamson, 2004; Scarborough, 2005). While these tasks may be vital to school functioning, they are misguided use of advanced graduates of counselor training programs. Furthermore, the participation in such activities may lead to role conflict and ambiguity, poor professional identity, minimization of school counselor skills and abilities, impaired work wellness (Culbreth, Scarborough, Banks-Johnson, & Solomon, 2005; Lambie & Williamson, 2004; Lieberman, 2004; Woods, 2009). Therefore, non-counseling related activities should be minimized with the goal of utilizing the school counselors' abilities to support the holistic development of all students.

Throughout the advancement of the school counseling profession, the focus was on the support of student development. Although the motivation, direction, and responsibilities have changes, school counselors are charged to improve the academic, personal/social, and career opportunities for students with the goal to support and efficient societal system. The current expectation regarding behaviors and responsibilities for school counselors are clear and specific (e.g., ASCA 2012). Nevertheless, some school counselors lack clarity regarding their roles

(Bodenhorn et al., 2010; Clemens, Milsom, & Cashwell, 2009), which necessitating further inquiry. The subsequent section reviews example of research examining factors that influence or are influenced by school counselors' programmatic service delivery.

Empirical Research on Programmatic Service Delivery

Bodenhorn and Luke (2008) examined the perspectives of school counselors who implemented comprehensive developmental school counseling program using a grounded theory qualitative study. The authors interviewed eight practicing school counselors (six females and two males) who identified as European American. The participants represented multiple states in the U.S. and all grade levels (e.g., K-12). Participant caseloads ranges from 175 to 410 and one participant was a K-12 director of guidance. The participants' years of experience ranged from four to thirteen years. The researcher used a semi-structured interview process that focused on specific topics (e.g., training, professional identity, important characteristics of school counselors). The data was collected through telephone interviews that occurred over 13-months.

The authors identified themes that motivation to help students, personal characteristics, training, model school counseling programs, role models, and school counseling experience contribute to casual conditions that lead to the phenomenon of implementing a comprehensive developmental school counseling program (Bodenhorn & Luke, 2008). Moreover, the authors identified factors associated with content, actions, and intervening conditions. Specifically, the contextual factors influenced the implementation of comprehensive developmental school counseling programs were school counselor self-efficacy and systemic awareness/integration (Bodenhorn & Luke, 2008). The actions that influence the implementation of comprehensive developmental school counseling program included marketing, planning, and evaluating. Finally, the intervening conditions that influence comprehensive developmental school counseling

program include facilitating and deterring. These three factors all led to the consequence of perceived opportunities to serve all students. The authors emphasize that the participants had a personhood that supported the intentional and direct attempts to create and facilitate the comprehensive developmental school counseling program, which they state is a primary ingredient for success. While this study provides relevant information, the study limitations included: (a) limited geographical diversity and (b) limited discussion on participant values that may be influenced the meaning making of program implementation. Nevertheless, an important finding that relates to this study was that school counselor self-efficacy is a contextual factor that is related to the implementation of comprehensive developmental school counseling programs.

Shillingford and Lambie (2010) investigated the relationship between school counselors' leadership practices, values, and programmatic service delivery in a single southeastern state ($N = 163$). In their study, participants indicated the most frequent service they provided was coordination ($M = 39.34, SD = 8.86$), with next most frequent services being counseling ($M = 33.41, SD = 6.95$), other unrelated activities ($M = 32.08, SD = 6.56$), consultation, ($M = 26.47, SD = 4.91$), and curriculum ($M = 22.40, SD = 8.05$; *scores represent total scale scores*). The findings from Shillingford and Lambie (2010) differed from Herbert (2007) who found that participants ($N = 305$) from a single southern state indicated consultation was the most frequent service ($M = 3.6, SD = .7$), then curriculum ($M = 3.4, SD = 1.3$), counseling ($M = 3.39, SD = .67$), other unrelated activities ($M = 3.10, SD = .74$), and coordination ($M = 3.0, SD = .83$; *scores represent average item scores per subscale*). Also, Clark (2006) found that school counselors in a single southern state ($N = 110$) reported that curriculum was the most frequent service ($M = 3.72, SD = 1.10$), then coordination ($M = 3.68, SD = 0.62$), counseling ($M = 3.65, SD = 0.61$), consultation ($M = 3.57, SD = 0.66$), other unrelated activities ($M = 3.33, SD = 0.64$; *scores*

represent average item scores per subscale). Interestingly, these three aforementioned studies returned varied results but all drew from unique, single state populations of school counselors. Thus, a national and more rigorous sample of participants may return different results.

Clemens and colleagues (2009) examined the effect of school counselor-principal relationship and school counselor's advocacy skills on the school counselors' role definition and program implementation using a path analysis ($N = 188$). The researchers sampled three Southeastern states in the U.S. using cluster sampling. Clemens et al. (2009) used weighted least squares estimation methods and utilized multiple fit indices (e.g., chi-squared fit statistic, root mean square error of approximation [RMSEA], comparative fit index [CFI], and standardized root and mean square residual [SRMSR]) based on recommendations (e.g., Kline, 2005). The researchers reported all fit indices for the path diagram were good, including: (a) chi-square fit statistic ($\chi^2 = 7.41, df = 6, p = .28$), (b) RMSEA (.04), (c) CFI (.99), (d) SRMSR (.03). The school counselor-principal relationship had a significant contribution with an effect estimate of $-.025$ ($p < .05$), which indicates that the stronger the relationship between the school counselor and the principal the more the school counselor implements the ASCA national model for the samples school counselors. In addition, self-reported school counselor self-advocacy skill had an effect estimate of $-.24$ ($p < .05$), indicating that as school counselors lack self-advocacy skills they implement fewer programs for the samples school counselors. Further research can support these findings by researching these constructs with a more rigorous sampling method and an increased sample size.

Hatch and Chen-Hayes (2008) investigated members of ASCA's beliefs regarding the ASCA *National Model*. Specifically, they sought to school counselors' beliefs regarding the importance of certain components of comprehensive developmental school counseling programs.

In addition, the study describes the development of an instrument to assess these beliefs. The researcher surveyed 3,000 ASCA members who were practicing school counselors across the U.S., resulting in a 43% response rate ($N = 1,279$). Of these participants, 34% ($n = 433$) worked at the elementary school level, 21% ($n = 267$) worked at middle/junior high school, 30% ($n = 389$) worked at the high school level, 8% ($n = 101$) worked at multiple levels, 5% ($n = 64$) worked as program supervisors, and 2% ($n = 25$) did *not* respond to this item. Regarding ethnicity, 92% ($n = 1,162$) reported as White, 3% ($n = 35$) reported as African American, 2% ($n = 23$) reported as Latino, 1% ($n = 15$) reported as Asian/Pacific Islander, 1% reported as Multiracial, and .5% ($n = 6$) reported as Native American. Regarding gender, 83% ($n = 1,041$) reported as female and 17% ($n = 238$) reported as male. All 3,000 potential participants were sent an instrumentation packet that consisted of a cover letter, the instruments used, and a return envelope. After 20 days, a reminder postcard was sent and after a month, a new packet was sent. The instruments used in this study were the *School Counseling Program Component Scale* (SCPCS; Hatch & Chen-Hayes, 2008) and a demographics questionnaire.

The SCPCS was developed based on (a) a review of the literature, (b) focus group discussions with school counseling leaders, and discussions with ASCA leadership (Hatch & Chen-Hayes, 2008). The SCPCS includes 19 items that score on a 5-point Likert scale ranging from 1 (very important) to 5 (*not* important). The survey was piloted with norming groups that consisted of school counselors at multiple levels. The SCPCS resulted in four factors that include: (a) use of Data for Program Planning (five items), (b) use of Data for Accountability (six items), (c) Administrator Support (four items), and (d) Mission, Goals, and Competencies (four items). The Cronbach's Alpha for each factor was .82, .80, .78, and .86 respectively, with the full scale being .92. The results of this investigation indicated that the report of data was

moderately important but program foundation and administrator support were more important. These results are important because they indicate that the participants' felt that foundational factors of the ASCA *National Model* (e.g., mission, goals, and competencies) are more important aspects the use of data and accountability information. Despite these findings, the study has some limitations, including: (a) limited diversity in sampled population (e.g., all members of ASCA) and (b) limited elaboration of scale development procedures. However, the study's findings identified the need to examine the specific service delivery activities of school counselors to develop a more comprehensive understanding about the importance of data and accountability in school counselors' service delivery activities as defined by the ASCA national model.

Scarborough and Culbreth (2008) studied school counselor preferences in service delivery activities and what variables relate to the discrepancy between preferred and actual service delivery. The participants included 600 potential respondents from two southern states (300 per state) that were collected from state school counseling associations. The response rate for these participants was 60% ($N = 361$; 180 from one state and 181 from the other state). The participants' gender was 89.3% female and 10.7% male (authors did *not* provide sample n for gender). In regards to ethnicity, the participants were 10.7% African American, .3% Asian American, 1.1% Native American, 0.6% Hispanic American, and 87.3% European American (authors did *not* provide sample n for ethnicity).

The authors collected the data through tailored design methods (e.g., Dillman et al., 2009; Scarborough & Culbreth, 2008); however, no incentive was used. The instruments used in this study included the SCARS (Scarborough, 2005), the *Counselor Self-Efficacy Scale* (CCS; Sutton & Fall, 1995), the *School Climate Survey* (SCS; Sutton & Fall, 1995), and a demographics questionnaire. The author used the CCS, SCS, and demographic variables in addition to looking

at the mean difference between actual and preferred scores on the SCARS. The SCARS and a 48 items instruments that measures two scales, preferred and actual. Within the SCARS, there are five subscales, including: Counseling, Consultation, Coordination, Curriculum, and Other Activities. These subscales intend to measures participants reported preferred and actual service delivery activities that are derived from the prescribed activities in the ASCA National model (Scarborough, 2005). The Cronbach's Alphas for each subscale in this study were as following: (a) Curriculum – Preferred (.90), Actual (.93); (b) Coordination – Preferred (.85), Actual (.84); (c) Counseling – Preferred (.83), Actual (.85); and (d) Consultation – Preferred (.77), Actual (.75). In addition, the SCARS measures three subscales related to non-counselor activities, including: (a) Clerical Activities, Fair Share Activities, and Administrative Activities. The Cronbach's alphas for these scales ranged from .43 to .84. The CSS scale is a 33 item 6-point Likert scale that measures counselors' outcome expectancy, efficacy expectancy (multifaceted), and efficacy expectancy (counseling). The CSS had Cronhach's alpha ranging from .61-.83. The SCS is a 6-point Likert scale designated to measure school climate factors and the Cronhach's alpha for SCS was .95 with these data.

The results of a paired sample *t* test indicated that there were differences between overall and subscale scores on the preferred and actual scales of the SCARS, $t = -21.22, p < .001, d = 1.02$ (Scarborough & Culbreth, 2008). Moreover, each subscale had a difference, including (a) Curriculum – ($t = -15.13, p < .001, d = .68$); (b) Coordination ($t = -17.77, p < .001, d = .99$); (c) Counseling – ($t = -20.03, p < .01, d = 1.09$); and (d) Consultation – ($t = -7.52, p < .01, d = .32$). These results reflect that school counselors have an inclination to preferring to partake in activities associated with the *ASCA National Model*. Additionally, the findings supported that many counselors are *not* able to facilitate their preferred activities.

Scarborough and Culbreth (2008) conducted several regression analyses that examined the predictor variables of service delivery and found that high school counselors are least likely to be facilitating in the way they prefer and elementary school counselors practiced in the way they preferred. In addition, practitioners who have more experience, practice in a more preferred manner. Moreover, school counselors who implemented the *National Standards for School Counseling Programs* (Campbell & Dahir, 1997) were more likely to be doing their preferred activities. Supportive school culture and outcome expectancy both predicted the difference between actual and preferred activities. Essentially, counselors who believed there would be better outcomes were more likely to complete their preferred practices. This study had limitations, including: (a) the use of a single state for sampling and (b) the sample consisted only of school counselors who are members of a state association. Nonetheless, this study's findings provide relevant information pertaining to factors associated with school counselor service delivery, including that self-efficacy contributes to service delivery.

School Counselors' Self-Efficacy, Professional Quality of Life, and Service Delivery

Chapter Two reviewed the theoretical underpinnings and empirical research regarding school counselors' self-efficacy, professional quality of life, and service delivery. The various works that have related self-efficacy to service delivery and its' related factors were presented. In addition, the factors associated with counselors' professional quality of life were reviewed. Furthermore, factors correlating with school counselors' service delivery were identified. Next, the connection between these three constructs of interests is offered.

Baggerly and Osborn (2006) investigated the correlates and predictors of career satisfaction by examining various independent factors, including school counselors' self-efficacy and job duties. Their instrumentation was the *Florida School Counselor Survey*, which was

adapted from the 1994 Texas Education Agency (1996) survey for Florida. They survey used a four-point Likert scale to assess various constructs. The authors examined correlations and regression analysis to test their data. Their results supported that school counselors' completion of school counselor roles (as identified by ASCA) positively correlated to job satisfaction ($r = .14, p < .01$). Conversely, school counselors' completion of ASCA identified inappropriate job responsibilities negatively correlated to job satisfaction ($r = -.18, p < .01$). While both correlations are small, they are statistically significant. Notable, self-efficacy regarding appropriate school counselor duties did *not* have predictive ability in relation to job satisfaction ($b = .003, t = .065, p > .05$) or job commitment ($b = .061, t = -1.59, p > .05$). While the results provide relevant findings, their study had limitations, including: (a) a questionable survey that was used and (b) a single state was used for sampling. This study's findings indicated there is a relationship between job satisfaction and the job duties of school counselors. However, it suggests that self-efficacy may *not* be a predictor of job satisfaction. Therefore, this study builds off the Baggerly and Osborn (2006) study by using more comprehensive measures to examine the constructs and attempt to find a positive contribution of self-efficacy and professional quality of life to school counselor service delivery.

Woods (2009) examined self-efficacy as a mediator between non-counseling roles and school counselor wellness through a an email survey of school counselors who were members of a national school counseling association in the state of Texas. The total response included 1,456 participants with 980 usable responses. Of the respondents, 87% ($n = 854$) were female and 19% ($n = 126$) were male. The participant's average age was 41 ($SD = 11.4$). Regarding ethnicity, 87% ($n = 858$) reported being Caucasian, 5.8% ($n = 57$) reported being African American, 4.6% ($n = 45$) reported being Hispanic, 1.3% ($n = 13$) reported being Asian/Pacific Islander, 0.4% ($n =$

4) reported being Native American, and 0.6% ($n = 6$) did *not* report their ethnicity. The researcher utilized four instruments in this investigation, including: (a) a demographics questionnaire, (b) the SCARS (Scarborough, 2005), (c) the 5FWel (Meyers & Sweeney, 2005), and (d) the SCSEs (Bodenhorn & Skaggs, 2005). The author used the *Work Wellness* subscale under the creative self on the 5FWel, which measures an individual's welling being in relation to their work environment. The 5FWel measures a similar construct as the ProQOLs; however, the ProQOLs is briefer and more focused on topics of interest to counselor's *professional* wellbeing (e.g., burnout, compassion satisfaction/fatigue)

Woods (2009) examined the bivariate correlations of the measured variables. Years of experiences correlated with the all items on the SCSEs, with correlations all significant at the $p < .01$ level and ranging from .108 to .302. Work wellness was correlated with all subscales of the SCARS, with correlations *all* statistically significant at the $p < .01$ level. The four subscales that focused on positive school counselor roles correlated ranging from .161 to .282. Notable, Work Wellness negatively correlated with non-counseling activities. Additionally, Work Wellness correlated with the all items on the SCSEs, with correlations all significant at the $p < .01$ level and ranging from .157 to .328. Additionally, three of the five subscales for the both the SCARS and SCSEs correlated, with non-counseling activities *not* having a correlation with any of the SCSEs subscales. The correlations were all at the $p < .01$ level with a range of .84 to .508. In addition, Cultural Acceptance (subscale on SCSEs) and Curriculum (subscale on SCARS) did *not* correlate ($r = .05$, $p = .121$). Noteworthy, the strongest correlation among the SCARS and SCSES subscales was between Coordination (subscale on SCARS) and Leadership and Assessment (subscale on SCSEs; $r = .413$, $p < .001$).

The results from the bivariate correlation analysis indicate the existence of relationships between these variables (Woods, 2009). In addition to this analysis the author tested two models using Structural Equation Modeling. Of these models, a significant finding was that school counselors' self-efficacy was a strong predictor of work wellness. Furthermore, Wood found higher levels of non-counseling duties predicted lower levels of work wellness. The study contained limitations, including: (a) the sample consists of participants who are members in a national counseling association and (b) limited articulation regarding the method of survey collection. Nonetheless, the study's findings support that the constructs of self-efficacy, service delivery, and work wellness have some form of relationship as evidenced by the identified correlations. This current investigation continued to examine and replicate the directional relationships between self-efficacy and work wellness (e.g., professional quality of life). Moreover, Woods (2009) examined the directional relationships between service delivery and these constructs.

Survey Research Methodology

At the root of any research investigation is a question that guides the methodology being utilized (Gall et al., 2007). Surveys are tools researchers use to gather information to describe and understand a respondent's knowledge, feelings, beliefs, values, behaviors, and states of mind (Fink, 2006). Survey research includes studies that involve the use of surveys, instruments, or questionnaires that seek to learn about target population (Gall et al., 2007). *Status surveys* seek to articulate the current status of a given target population (Graziano & Raulin, 2006). Status surveys take a snapshot of a population through the lens of the constructs of interest with the goal of better understanding that population. Additionally, surveys are used to examine the relationships among measured multiple constructs or variable (Gall et al., 2007; Graziano &

Raulin, 2006; Johnson & Christensen, 2004). Surveys can be used to assess change over time (e.g., longitudinal) or single collection perspectives (Gall et al., 2007). No matter the purpose, survey research has similar principals related to methodology and sampling.

Surveys can be conducted through multiple means of respondent interaction, including: (a) face-to-face interview, (b) telephone interview, (c) mail based, and (d) web based (Fink, 2006; Rea & Parker, 2005). Researchers (i.e., Dillman et al., 2009) advocate for the integration of multiple forms of data collection (the use of mail contacts with email follow up contacts) because they produce better response rate than a single method and diversify respondent interaction. Respondent interaction type has developed over time based on cultural and technology changes (Dillman et al., 2009).

Generally speaking, the interaction between participant and researcher has grown over time to be less interactive and more remote with developing focus on the use of technology as a vehicle for obtaining participation in surveys (Converse, 1987; Granello & Wheaton, 2004; Rea & Parker, 2005). Prior to the 1970's, face-to-face survey administration was normal method for data collection in the social sciences (De Leeuw, Mellenbergh, & Hox, 1996). Since the 1970's, paper based questionnaires and instruments (e.g., mail based or face-to-face administration) are historically common (Dillman et al., 2009). Newer methods of data collection are encouraged (Granello & Wheaton, 2004) and are beneficial due to ease in respondent interaction, cost, and time (Hayslett & Wildemuth, 2004; Hine, 2005). For example, Harris (2013) conducted a web based survey of 10,724 school counselors using the ASCA online directory as a free source of participant email addresses, which was a low cost and fast method as compared to mail or face-to-face based methods. Nonetheless, Harris obtained a small response rate of 14% ($N = 1,627$) as

compared to mail based surveys with commonly return higher response rates (e.g., 50.9%; Lawson, 2007).

Researchers have concerns regarding the difference in response characteristics based upon collection method (e.g., Couper & Miller, 2008; Dillman et al., 2009; Link & Mokdad, 2006). Research comparing web and mail based surveying has produced inconsistent findings (Greenlaw & Brown-Welty, 2008; Shih & Fan, 2008; Wolfe, Converse, & Oswald, 2008). On the whole, web based surveys have lower unit response rates when compared to mail surveys (Shih & Fan, 2009), with a few exceptions where web based surveys return higher unit response rate as compared to mail surveys (e.g., Greenlaw & Brown-Welty, 2008). The inconsistent findings in unit nonresponse rate may be a result of differences in study design or administrative aspects of the survey (Couper & Miller, 2008; Dillman et al., 2009). In addition, studies with a low response rate can still be considered a viable tool (Shih & Fan, 2009); however, the study results should be interpreted with caution.

Groves, Fowler, Couper, Lepkowski, Singer, and Tourangeau (2004) suggested four perspectives of survey research to examine, including: (a) survey purpose, (b) question standardization, (c) sampling methodology, and (d) data collection methods. The purpose of surveys can include collecting a census (e.g., systemic effort to collect data from an entire population), examining a social issue, investigating theoretical constructs and their relationships, and examining public opinion in relationship to political affairs or commercial items. In their early use, surveys were designed for consensus regarding taxation and population documentation (Converse, 1987, Groves et al., 2004; Wright & Marsden, 2010) and can be traced back to use with the Roman and Egyptian civilizations. Today, surveys serve as a common tool in

educational and social science research (Gall et al., 2007; Hackett, 1981) and public opinion polls (e.g., market research; Groves et al., 2004).

The standardization of questions in surveys helped to solidify its place as a useful data collection method (Converse, 1987; Groves et al., 2004). The art of measuring subjective states (e.g., states that cannot be observed) required that researchers examine the wording scoring systems used in surveys. Early researchers (e.g., Likert, 1932; Thurstone & Chave, 1929) initiated efforts to assign numbers to feelings or states of being through the study of question working and psychometric properties of surveys. Furthermore, researchers have identified best practice methods of designing and laying out surveys so that they support response rate (e.g., Dillman et al., 2009; Groves, Dillman, Eltinge, & Little, 2002). Dillman and colleagues (2009) developed the *Tailored Design Method* of surveying which is built upon the *Social Exchange Theory* (SET; Emerson, 1976). In survey research, SET represents the phenomenon in which people are more likely to respond to a survey if the reward (intrinsic or extrinsic; monetary or nonmonetary) outweighs the costs of participation (Dillman et al., 2009; Emerson, 1976). Therefore, Dillman et al., (2009) offered strategies that address all aspects of communication to make the participation in surveys more rewarding and less costly. Cumulative research and literature on survey questioning and formatting has led to widely accepted techniques of survey development (e.g., Dillman et al., 2009).

In early survey research, practitioners aimed to obtain responses from *all* population members (Groves et al., 2004; Wright & Marsden, 2010); however, this method is impractical in large-scale research studies. The theory of probability was *not* applied to sampling methods until the 20th century (Grooves et al., 2004) with the advent of *probability sampling*. The field of agriculture contributed sampling methodology through its development of area probability

sampling, which is the sample of typical farmland based upon seasonal crops with the goal of predicting the crops for sequential season crops (Converse, 1987; Grooves et al., 2004).

Furthermore, the depression and World War II were catalysis for survey research sampling practices as the U.S. government sought to gather data to guide decision-making and interventions (Converse, 1987; Grooves et al., 2004).

Sampling is a vital part of conducting survey research. A goal of survey research is the ability to examine the relationship of variables and make statements about target populations (Hackett, 1981). Therefore, a representative sample of the target population is important. Survey sampling theory is a division of statistics that focuses on the methods of sample selection for larger populations (Frankel, 2010). *Probability sample* is the selection of participants in a manner that gives each member of a target population an equal chance of being selected (Gall et al., 2007). Unique to probability sampling is that each known member of a population is given an equal opportunity for selection (Frankel, 2010). Different types of probability sampling exist, including: (a) simple random, (b) systematic random, (c) stratified random, (d) random cluster, (e) stratified cluster, and (f) complex multistage random sampling (Gall et al., 2007; Graziano & Raulin, 2006; Johnson & Christensen, 2004). Initially, probability sampling was found sound but costly and restrictive (Frankel, 2010); however, overtime was found more effective than nonprobability sampling. *Nonprobability sampling* (e.g., quota, purposive, and convenience) is the selection of participants in a manner that limits the opportunity for each member of a given population to be selected for participation (Gall et al., 2007). Nonprobability sampling is another common approach in survey research (Grooves et al., 2004; e.g., Lambie, Ieva, Mullen, & Hayes, 2011) but has limited representativeness of the population due to high bias based on the selection criteria, which limits the generalizability of nonprobability samples

(Gall et al., 2007; Graziano & Raulin, 2006). Yet, nonprobability sampling is a lower cost and in some cases more effective for the identified population (Gall et al., 2007; Johnson & Christensen, 2004).

School counseling researchers often use organizations (i.e., ASCA; Harris, 2013; Bodenhorn et al., 2010) to obtain participants for survey research. However, these populations do *not* represent all school counselors but instead only those who hold membership in their respective organizations. A sample that represents the population of *all* school counselors would need to include be drawn from a database of every school counselors in the U.S. (e.g., Common Core Dataset). Furthermore, common sampling methods used in school counseling research includes the use of: (a) simple random sampling of ASCA members (e.g., Lambie, 2007), (b) simple random sampling of single (or a few) state(s) school counselors (e.g., Clemens et al., 2009; Wilkerson, 2009), (c) cluster random sampling (*state-level*; e.g., Pryne, 2011) and (d) convenience sampling (*nonprobability*; e.g., Bodenhorn & Skaggs, 2005). Overall, the consistency of sampling methods and the rigor to represent *all* school counselors is limited. Nevertheless, researchers should clearly describe the intended population for which their results can be inferred (Gall et al., 2007). If researchers seek to examine interest for all school counselors they should sample accordingly.

Nonresponse in Survey Research

Researchers have sought to identify key factors in increasing response rates in survey research. *Unit nonresponse* takes place when a sample unit (participant) does *not* complete survey and most often occurs due to participant refusal to complete or ineffective communication with a participant (Dixon & Tucker, 2010). Nevertheless, unit nonresponse complicates inference drawn from the results if the act of nonresponse relates to the variables investigated and the

results of the analysis (Little & Rubin, 2002; Rubin, 1987). The research on unit nonresponse identified that electronic methods of data collection have a lower response rate as compared to traditional methods (e.g., mail-out surveys; Cole, 2005; Kwak & Radler, 2002; Leece et al., 2004; Wolfe, Converse, Airen, & Bodenhorn, 2009; Wolfe, Converse, & Oswald, 2008). Moreover, some previous research comparing demographics characteristics of respondents based on survey methods identified that web-based survey respondents are more likely males (McCabe, Diez, Boyd, Nelson, & Weitzman, 2006; Wolfe et al., 2009) and there are racial based differences based on access to internet (Pew Internet & American Life Project, 2006). Specifically, Wolfe and colleagues (2009) found that internet-based respondents were two times more likely to be Caucasian versus a minority as compared to paper-pencil mail-out surveys, providing support that minority respondents are less likely to complete a survey online.

Item nonresponse is the act of participants *not* completing *all* items in the survey (Dixon & Tucker, 2010) and concerns the quality of the measures being used (Wolfe et al., 2009). Item nonresponse can result from respondents' limited availability (e.g., limited knowledge) to answer an item or unwillingness to provide information. In one case, 36% of participants left at least one item unanswered (Bosnjak & Tuten, 2001). Items that ask personal information or information that is of a sensitive nature (e.g., drug-buying rates) have a higher likelihood of lower response (Wolfe, 2003). Additionally, fill-in-the-blank items on web-based surveys have a higher likelihood of returning item nonresponse (Wolfe et al., 2008) as compared to other forms of response. Information on nonresponse is concerning and merits further investigation to better understand its impact on the inference one can make from a study's findings.

Nonresponse bias

The effect of nonresponse on estimates is termed *nonresponse bias* (Dixon & Tucker, 2010). Nonresponse bias occurs when the mean difference in estimates is different between respondents and non-respondents. While nonresponse rate is often known, the mean of estimates for non-responders is rarely known. Therefore, it is difficult to estimate the exact rate of nonresponse bias in most research. However, researchers can examine nonresponse bias by considering the how the data is missing. If the data is missing completely at random, then the mean in scores will no differ and there is no nonresponse bias (Dixon & Tucker, 2010). If the data is missing at random, adjustments can be made to account for the missing data and thus removes nonresponse bias. Both missing completely at random and missing at random nonresponse are considered ignorable. However, when data is missing in relation to constructs of interest for the study, the data is *not* ignorable and nonresponse bias plays a role in interpretation (Little & Rubin, 2002; Rubin, 1987).

Token incentive

The largest predictor of participant response in multiple contacts and the second largest contributor of participant response is the use of token incentives (Dillman et al., 2009). Dillman and colleagues suggest that token incentives support SET and serve as novel and unexpected gestures, which both increases response rate and decreases nonresponse bias. Different forms of incentive can impact both response rates and respondent characteristics. For example, Laguilles, Williams, and Saunders (2011) found that a lottery incentive had a positive impact on response rate and impacted the typical gender of respondents. Further, Hawley, Cook, and Jensen-Doss (2009) found that response rate varied based upon incentive type (e.g., no incentive, magnets, and \$1-\$5) amongst mental health practitioners ($n = 494$; $\chi^2 = 19.19$, $p < .001$); however, the larger monetary incentive (e.g., \$1, \$2, and \$5) did *not* produce a statically significant difference

in response rate for mail-out surveys ($n = 298$; $\chi^2 = 4.04$, $p = 0.13$). The impact of incentive for online survey has provided inconsistent results in relationship to an increased response rate and response quality (e.g., Sánchez-Fernández, Muñoz-Leiva, & Montoro-Ríos, 2012; Wilson, Petticrew, Calnan, & Nazareth, 2010). Nevertheless, there is a dearth of research on incentive in school counseling research, which supports the need to explore the influences of incentives in research with school counseling professionals.

Empirical Research on Survey Methodology

There is limited research on survey methodology in the school counseling field. Therefore, the following section describes research from similar fields to draw logical inferences about the characteristics that school counselors may have in regards to response to surveys. Dykema, Stevenson, Klein, Kim, and Day, (2013) surveyed 280 faculty members by three collection methods evenly (email, mail [no incentive], and mail with incentive) with the goal of examining and comparing data collection methods. Dykema et al. found the mailed invitation (with incentive) group response rate (38.3%) was slightly higher than the mailed group that did *not* receive an incentive response rate (30.1%) and a moderately higher response rate than the participants who only received an email (19.4%). In addition, Dykema et al. compared the *cost per completed survey* and found that mailed invitation (with incentive) group cost the most (\$9.09), the mailed invitation (with no incentive) group was second most expensive (\$4.43) and the email invitation was least expensive (\$1.49).

De Leeuw, Mellenbergh, and Hox (1996) compared the response rate based upon the method of collection for a random sample 1380 participants in the Netherlands using mail ($n = 400$), telephone ($n = 450$), and face-to-face surveying ($n = 530$). Du Leeuw et al. obtained a 68% (254) response rate for mail surveys, a 51% (243) response rate for face-to-face surveys, and a

66% (266) response rate for telephone surveys. Surprisingly, Du Leeuw et al. found a low face-to-face response rate, which the authors contribute to the cultural norm of refusing to be a part of surveys found in the Netherlands.

Kwak and Raddler (2002) surveyed 2,000 students in a large university in the U.S. to compare the use of mail and email data collection methods. Of these methods, the mail survey got a response rate of 42.5% ($n = 402$) and the email survey got a response rate of 27.4% ($n = 270$). The web survey has a faster average turnaround speed with 2.2 days as compared to 9.0 days for mail survey ($t = -20.89, p < .001$). Kwak and Raddler found that a higher percentage of respondents in the mail survey were women (59.6%) as compared to the slightly lower percentage of women in the web survey (49.6%;).

Greenlaw and Brown-Welty (2008) surveyed 3,842 participations (overall response rate of 51.58%; $N = 1,982$) by one of three methods, (a) paper based (response rate of 42.03%; $n = 538$), (b) web based (response rate of 52.46%; $n = 672$), or (c) mixed mode (response rate of 60.27%; $n = 772$) with the purpose of examining response rate and cost rate per data collection method. Interestingly, paper based survey had a lower response rate than web based, which contradicts other studies (e.g., Converse, Wolfe, Huang, & Oswald, 2008; Kwak & Raddler, 2002). The authors found that there was a difference in response between the methods of data collection ($F [2, 3,840] = 44.799, p < .001$). Furthermore, Greenlaw and Brown-Welty found that paper based surveys cost the most (\$4.78 per response) then mixed mode (\$3.61 per response) and web based (\$0.64 per response). While the results of this study identified the use of we based surveys, the results do *not* describe the characteristics of the sampled population, which may be difference based on method of collection.

Wolfe and colleagues (2010) compared the unit and item nonresponse rates of school counselors based on web and paper based survey administrations. The researchers drew a random sample of ASCA members and received a response rate of 41% ($N = 656$). The respondents were 83.5% female ($n = 548$) and 16.5% male ($n = 108$). The respondents ethnicity included 88.7% ($n = 582$) Caucasian, 4.9% ($n = 33$) African American, 2.0% ($n = 14$) multiracial, 1.5% ($n = 10$) Hispanic, 0.8% ($n = 6$) Asian American, and 0.6% ($n = 4$) Native American with 1.5% ($n = 10$) *not* reporting ethnicity. In addition, the unit response rate for the separate administrations (e.g., web or paper based) resulted in a statistically significant difference ($\chi^2 [1] = 207.47, p < .01$) with mail based administration having (response rate of 59%) five times greater likelihood of returning a response than web based administration (response rate of 23%; Wolfe et al., 2009). The overall item nonresponse rate was 4%, which means that on average each participant lefts 4 of the 107 survey items unanswered. The item nonresponse rate (mail based = 4.2%; web based = 3.5%) did *not* result in a statistically significant difference based on administration type ($F [1,654] = 2.7, p = .10$). This study provides relevant information in terms of the difference in response rate (both unit and item level) based on survey administration method with school counselors, which supports the need for further research. Future studies can supplement this study by examining other forms of data collection (i.e., face-to-face) and replicating the findings across multiple populations of school counselors (e.g., diverse sampling groups).

In a review of prominent journals that publish research on school counseling and school counseling research (e.g., *Measurement and Evaluation in Counseling and Development*, *Journal of Counseling and Development*, and *Professional School Counseling*), *no* articles examined the use of incentives to increase response rate or response quality. Moreover, there exist a single

article that investigates survey research and response related issues in school counseling research (e.g., Wolfe et al., 2009). Therefore, there is a need to explore survey research methodology to better understand how to conduct effective research with school counselors.

Chapter Two Summary

Chapter two presents the theoretical constructs and supporting empirical research regarding this study. Specifically, school counselor self-efficacy and programmatic service delivery were reviewed, including an overview of SCT. Next, the construct of professional quality of life was introduced, including the topics: (a) compassion satisfaction, (b) burnout, and (c) compassion fatigue. The chapter presented both the theoretical support of these three constructs of interest and the current research identifying the relationships between professional quality of life. Then, a historical review of the school counseling profession with a focus on the professional roles, responsibilities, and standards was provided. Research on school counselor service delivery was reviewed. Furthermore, the chapter presented the connection between the three theoretical constructs of interest, supporting the merit of the current investigation. In conclusion, the chapter reviewed survey research methodology, identifying the need for research examining survey methodology in the school counseling field.

CHAPTER THREE: METHODS

Chapter three reviews the method, research design, and procedures that were utilized in this investigation. The purpose of this investigation was to examine the directional relationship between practicing school counselors' level of professional quality of life (ProQOL) and self-efficacy to their programmatic service delivery activities. This investigation tested the theoretical model that practicing school counselors' level of ProQOL (as measured by the *Professional Quality of Life Scale* [ProQOLs; Stamm, 2010]) and their self-efficacy (as measured by the *School Counselor Self-Efficacy Scale* [SCSEs; Bodenhorn & Skaggs, 2005]) contribute to their service delivery activity (as measured by the *School Counselor Activity Rating Scale* [SCARS; Scarborough, 2005]). Specifically, this study examined the hypothesized directional relationship that school counselors who have higher ProQOL scores (e.g., less burnout and compassion fatigue and higher compassion satisfaction) and higher self-efficacy scores (e.g., more confident about counseling skills) have increased levels of programmatic service delivery facilitation (e.g., they do more school counseling activities for students and stakeholders). Also, the study investigated the relationship between the school counselors' self-reported demographic variables (e.g., ethnicity, age, years of experiences) and their ProQOL, self-efficacy, and service delivery scores. Furthermore, the study examined survey research methodology by comparing: (a) data collection methods, (b) sampling methods, and (c) incentive types.

This study utilized a nonexperimental descriptive, correlational research design (Gall, Gall, & Borg, 2007) to examine the research hypothesis and exploratory questions. The research design for this study is correlational due to the goal of determining directional relationships between the variables of school counselors' ProQOL, self-efficacy, and service delivery without manipulation (Fraenkel & Wallen, 2009). This chapter on research methodology presents the

following components regarding this study: (a) population and sampling procedures, (b) data collection methods, (c) study instrumentation, (d) research design/method, (e) research hypothesis and exploratory questions, (f) data analysis methods, (g) ethical considerations, and (h) study limitations.

Population and Sampling Procedures

Sample Size Determination

This study investigated the contribution of practicing school counselors' self-efficacy and professional quality of life to their programmatic service delivery with practicing school counselor as the target population being examined. Representativeness of research results to the target population is important to consider when determining sample size, which can be determined prior to data collection based upon the size of the population (Gall et al., 2007; Krejcie & Morgan, 1970). According to the Common Core Data from the Federal Department of Education, there were 105,078 school counselors nationwide during the 2010-2011 school year (most recent available school year). The United States (U.S.) Department of Education tracks basic records and demographic information for all public and private schools in the U.S. and make this information available to the public through the Common Core Data set (c.f. <http://nces.ed.gov/ccd/>). Therefore, to generalize the results to the population of practicing school counselors in the U.S. ($N = 105,078$) with a 95% confidence level, a minimum random sample of 384 was required (Krejcie & Morgan, 1970).

Sample size is an essential consideration in quantitative analysis and should be considered prior to data collection. Researchers should use the largest sample size possible for the target population because larger samples sizes increase the likelihood of obtaining a better representation of the population (Gall et al., 2007). Furthermore, sample size has a direct

relationship to statistical power with power increasing as the sample size increases (Gall et al., 2007). It is suggested that *a priori* power analysis is essential to guide sample size selection, which may avoid Type II errors (failing to reject a false null hypothesis; e.g., Balkin & Sheperis, 2011). Power analysis in SEM is important and there are several methods and recommendation to follow.

Schumacher and Lomax (2010) recommend the use of www.Danielsoper.com (*a priori* sample size calculator) to calculate required sample size. Based on this website, to identify a small effect size (0.1) and a high power (0.8) with three latent variables and 13 manifest variables at the probability level of $p < .05$, a minimum sample size of 290 was needed for this study. Moreover, MacCallum, Browne, and Sugawara (1996) provide a chart to guide sample size based upon degrees of freedom (*df*) and desired power for SEM analysis of power, which means based on $df = 65$ ($91[\text{known parameters}] - 29[\text{unknown parameters}] = 65$ [*df*]; MacCallum et al., 1996, pg. 142; Weston & Gore, 2006; see structural model) and a power estimate of .8 or higher, a sample size of approximately 200 was needed. Furthermore, Schumacker and Lomax (2010) state that many SEM articles “used from 250 to 500 subjects, although the greater the sample size, the more likely it is one can validate the model using cross-validation” (p. 42). In addition, Raykov and Marcoulides (2006) identified that when estimating sample size, “a cautious and simplified attempt at a rule of thumb might suggest that sample size would be desirably be more than 10 times the number of free model parameters” (p. 30). Therefore, a minimum sample size of 400 was an acceptable standard for this SEM research investigation with the aim to be generalizable to the population and provide a high degree of power (Krejcie & Morgan, 1970; MacCallum et al., 1996; Schumacker & Lomax, 2010).

Population

The study utilized both *convenient* and *simple random* sampling of school counselors in three separate data collection methods with unique samples. First, samples of participants from 10 separate, diverse school districts from across the U.S. were invited to participate in the study during a face-to-face administration of the survey (with approval from the IRB; Hox & DeLeeuw, 1994). The process of selecting potential school districts involved identifying districts that varied in location (e.g., urban, suburban, and rural) and size. Also, consideration was given those districts that were geographically different (e.g., in different states). Lastly, the researcher identified districts that were feasible (e.g., accessible based upon the financial ability and time availability of the researcher) to involve in the study. After contacting 10 school districts in eight different states, two responded with interest in participating in the study. During this data collection, participants were given the data collection packets and invited to complete the assessment instruments. The face-to-face administration group did *not* receive an incentive. The sample size goal of 200 participants was set for the face-to-face administration of the data collection packets because this sample size allowed a comparison across sampling methods and supports the overall goal of obtain, at minimum, 400 participants.

The second sampling method included paper-pencil mail survey using mixed methods (Dillman, Smyth, & Christian, 2009; Greenlaw, & Brown-Welty, 2009). A sample of participants received a paper-pencil mailing of the data collection materials and had the option of mailing back the completed instruments or completing the survey online (*mixed response method*). The sampling method drew from two sources of potential respondents, including: (a) the American School Counselor Association (ASCA) membership database and (b) a random selection of school counselors from the Common Core Dataset list of school in the United States (U.S.). For ASCA membership database, the researcher contacted an ASCA staff member to obtain the

mailing address of 2,000 practicing school counselor members (randomly selected from the ASCA membership Data base; at all grade levels) to use in the mailing of the paper-pencil mixed mode surveys (the cost of the mailing addresses was \$250.00). Regarding the school counselors from the Common Core Dataset, the researcher extracted a list of every school in the country. Then, the researcher randomly identified 300 schools. Of these schools, the researcher then identified a school counselor for the school and to mitigate bias in the school counselor selection, the researcher randomly selected (using Microsoft Office's excel RAND option) a single counselor from each school. In total (e.g., ASCA Membership and Common Core Dataset participants), this mail survey sample group targeted 600 participants (300 per population) with an expectation that 50% ($N = 300$) may complete the survey based on prior research study using a similar methodology (e.g., Bodenhorn, Wolfe, & Airen, 2010; Lawson, 2007; Sutton & Hall, 1995; Wolfe, Converse, Airen, & Bodenhorn 2009).

The third sampling method included the use of online survey methods (Dillman et al., 2009). For the online survey sampling method, 3,000 participants were selected from ASCA's online membership directory. The online directory is available for members of ASCA to use in connecting with other ASCA members. ASCA members have the option to post their email address and other professional information in the directory upon joining ASCA. In addition, these potential participants were screened to assure they were practicing school counselors and *not* students, administrators, or counselor educators. Permission to use the ASCA online directory as a participant database was granted through personal communication (through e-mail; See appendix) with Kathleen Rakestraw, the Director of Communications for ASCA. Specifically, the researcher randomly selected individuals from this online directory who are practicing school counselors and who are *not* already included in the other two sampling pools.

The names and email addresses of all potential participants were cross-analyzed to check for duplicate sampling. Then, these potential participants were emailed an invitation to an online version of the study. Response rate for online surveys with school counselors varies; however, the researcher anticipated 300 (10% response rate) participants based on previous research (Limberg, 2013; Shih & Fan, 2009; Wolfe et al., 2009).

As a result of these three sampling populations (face-to-face administration, paper-pencil mail survey, and online survey), this investigation is expected to have a usable response rate of 800 participants. The diverse sampling methods were established with the goal of obtaining as comprehensive and accurate representation of practicing school counselors. Response rate is often times viewed as an indicator of quality regarding the participant's response (Hox, & DeLeeuw, 1994). However, inconsistency in these findings may indicate that the non-response is *not* as important as many believe (Shih & Fan, 2009). Therefore, this study's comprehensive sampling methods examine the response variance based upon the sampling groups by comparing respondent response rate across the data collection methods. Thus, if similar scores are found amongst the different sampled populations then the researcher can conclude: (a) all the data equally represents the constructs being measured and (b) the sampling methods are equivalent despite the variance in response rate (Shih & Fan, 2009).

Data Collection

This study employed both convenient and simple random sampling. Convenience sample is a method of selecting participants when using one or more pre-identified groups (Fraenkel & Wallen, 2009). Moreover, convenience sampling is a nonprobability sampling technique that is characterized by targeting specific areas or groups for a study to obtain a representative sample (Kerlinger, 1986; e.g., geographical representation). Simple random sampling is the process of

selecting a sample of participants from a larger population in a way that every person has an equal chance of being chosen for participation (Fraenkel & Wallen, 2009). The face-to-face populations used the convenience sampling methods. To sample the population of ASCA members, the researcher utilized simple random sampling of the purchased membership list and online directory. To sample the population of *all* practicing school counselors the utilized the Common Core Data set and used simple random sample to identify participants for this study. Thus, the participants were both general practicing school counselors and practicing school counselors who are members of ASCA.

Prior to any collection of data, the researcher applied for permission from the University of Central Florida's Institutional Review Board (IRB) to conduct the study. Once IRB approved the study, initial contact was made with the school district leaders to inquire about participation in the study (See appendix). The researcher identified districts that varied in location (e.g., urban, suburban, and rural) and size. Also, the researcher identified school districts that were geographically different (e.g., in different states). Lastly, the researcher identified districts that were feasible (e.g., accessible based upon the financial ability and time availability of the researcher) to involve in the study. If the school district allowed the study to take place, the researcher completed the needed forms to administer the surveys at the willing school districts' *Offices of Evaluation and Research* to obtain permission to conduct the study. Moreover, permission to use the instruments (ProQOLs [Stamm, 2010]; SCSEs [Bodenhorn & Skaggs, 2005]; and SCARS [Scarborough, 2005]) was verified (See appendix).

First, the survey was administered at the school counseling professional development meetings of the two school districts during the Fall 2013 school year. The researcher scheduled the dates to meet with each school counseling coordinator individually and collect the data from

the participating school counselors. The participants were able to opt out of participating or withdrawal at any time from the study (e.g., informed consent; General Demographics Form; ProQOLs [Stamm, 2010]; SCSEs [Bodenhorn & Skaggs, 2005]; and SCARS [Scarborough, 2005]). Each participant received an envelope that has *no* identifying information. If they wish to opt out of the study, they simply turn in an incomplete/blank envelope. If they choose to participate, they completed the data collection instruments and seal the envelope. Either way, when the participants are finished they return the envelope back to the researcher. Once all the participants complete the data collection packets, the research thanked the participants and left. All envelopes were seal and kept sealed until the research beings the data entry process. When the data entry process begins, each participant's data collection instruments were coded with a number to track that envelopes score and results. No identifying information (e.g., name, employee id, address) was collected.

To reduce measurement error, the instruments were checked, rechecked, and piloted to assure legibility and understandability (Dillman et al., 2009). The researcher checked and rechecked the instruments for legibility and understandability. Then, the researcher had 10 colleagues (e.g., researchers) pilot the instruments for legibility and understandability. Then, the instruments (e.g., ProQOLs, SCSEs and SCARS) and the consent and demographics were formatted to support legibility and understandability. Feedback from the colleagues and dissertation committee was incorporated into the development of the instrument packets.

After the in person administration, participating school districts were offered the opportunity to have the researcher present the findings and their implications to the districts school counselors. Additionally, the researcher offered to provide a video module with an

assessment on the topic of school counselor career sustaining mechanisms for the district's ongoing use. One district requested the researcher return to present the findings of the study.

The second method of data collection was through mixed-method, paper-pencil mail out of instrumentation packets. In the paper-pencil collection method, participants received the same aforementioned instrumentation packet. However, the mixed-method, paper-pencil mail out method followed the recommended *Tailored Design Method* to surveying (Dillman et al., 2009). The following steps took place: (a) participants were mailed an initiation letter and instrument packet (e.g., informed consent; General Demographics Form; ProQOLs [Stamm, 2010]; SCSEs [Bodenhorn & Skaggs, 2005]; and SCARS [Scarborough, 2005]); (b) after one week, participants were mailed a reminder/thank you post card; (c) after two weeks, non-respondent participants were mail another instrument packet; and (d) after three weeks, non-respondent participants were mailed a final request to participate. In addition, when participants received the letter inviting them to participant and instrumentation packet (first step), they had the option to complete the survey online or by completing and returning the instrumentation packet. All participants were assigned a *personal access code* to use when completing the survey to support their anonymity. Copies of these letters are included in the appendix.

Response rate is an important survey research design concern (Hox & DeLeeuw, 1994). To encourage survey completion participants were contacted multiple times (Dillman et al., 2009). The second method for improving response rate is the use of monetary or non-monetary (e.g., donation on behalf of the participant) incentive (Dillman et al., 2009). Incentive in survey research increases response rate (Church, 1993). Moreover, Dillman and colleagues (2009) indicate that the largest increment in response rate is the results of going to \$0 incentive to \$1 incentive; however, as the amount of incentive increases, so does the likelihood of response rate.

In regards to school counselor survey research, Wolfe and colleagues (2009) found that participants are more likely to respond by mail (59%) than by web (23%). Furthermore, they identify the need to examine response rate issues to support research with school counselors (Wolfe et al., 2009). Therefore, on the initial mailing, participants received either (a) no incentive, (b) \$1 token incentive, or (c) \$2 token incentive for participating in the study (incentive type was coded in the participant database). The varied incentive sought to identify an effective incentive for school counselor survey research. These groups were randomly assigned to all mixed-method, mail-out survey recipients.

The final sampling method includes email/web-based survey, which also followed the *Tailored Design Method* (Dillman et al., 2009). Participants were randomly selected from the ASCA online membership directory. The instrument packets used in each previously described administration were converted into an online survey using Qualtrics.com. Each participant received three emails through Qualtrics.com. The first email was an introduction to the study, a link to participate, and information regarding the IRB approval. The second e-mail was a reminder email for any individuals who did *not* complete the study. The third and final email was another reminder email. The appendix contains copies of each email, which are developed based on *Tailored Design Method* (Dillman et al., 2009). Participants either did *not* receive an incentive or a donation of \$1 was made to the American Red Cross on their behalf. Selected participants were randomly assigned to either the nonmonetary incentive group or the no-incentive group. The use of nonmonetary incentive is an effective and efficient method to increase response rate in electronic surveys (Church, 1993). Table one provides a summary of the research sample and sampling procedures.

Table 2 *Sampling Characteristics*

Sampling Method	Sampling Type	Sample	Sample Size (<i>Esti. Response</i>)
Face-to Face	Convenient	Practicing School Counselors in Two Different Districts	200(200)
Mixed Method Paper Pencil	Simple Random	ASCA Members and Practicing School Counselors in the U.S.	600(300)
Email/Web-based	Simple Random	ASCA Members in the Online Directory	3000(300)
Total			3800(800)

Instrumentation

Four data collection instruments were used in this study, including (a) a *general demographics questionnaire*, (b) the ProQOLs, (c) the SCSEs (Bodenhorn & Skaggs, 2005), and (d) the SCARS (Scarborough, 2005). The instruments used in this study are included in the appendix. The next section of the chapter reviews each of the data collection instruments and the psychometric properties of the instruments with diverse populations.

General Demographics Questionnaire

This study utilizes a general demographics questionnaire to collect participant data and self-report information. The general demographics form was created by the researcher and can be found in the appendix. The general demographics questionnaire requests the following information from participants: (a) ethnicity/race; (b) age; (c) gender; (d) current school level (e.g., elementary school, middle/junior high school, and high school); (e) years of experience as a teacher prior to the current year (zero indicates no teaching experience); (f) years of experience as a school counselor prior to current year (zero indicate it is their first year as a school counselor); (g) school location (e.g., rural, urban, suburban); (h) type of school setting (e.g.,

regular school [private or public], career center, special education center, alternative education), (i) degree level (e.g., masters, educational specialist, or doctorate), (j) graduate program CACREP status, (k), current professional membership status, and (l) open comment box.

In addition, the general demographics questionnaire included 12 five-point Likert scaled statements that assess following topics: (a) principal-counselor relationship, (b) role ambiguity/role control, (c) job satisfaction, (d) job stress, and (e) subjective wellbeing (one item). These topics address issues related to other studies conducted on service delivery (e.g., Clemens et al., 2010). Each topic is addressed through three separate items developed by the researcher. The psychometrics of these items was assessed using the data from this study. To support the face validity and reliability, the dissertation committee, research colleagues, and school counseling professionals reviewed these items (expert review).

Professional Quality of Life Scale (ProQOLs)

The ProQOLs (Stamm, 2010) is a 30-item self-report instrument that measures two compassion factors, which include compassion satisfaction and compassion fatigue. Compassion fatigue is broken into two subscales, which include burnout and compassion fatigue (e.g., secondary traumatic stress). Overall, the ProQOLs consists of three subscales, including: (a) *compassion satisfaction* (10 items), (b) *burnout* (10 items), and (c) *secondary traumatic stress* (10 items). Burnout and secondary traumatic stress combine to represent compassion fatigue.

Initially, the ProQOLs was called the *Compassion FatigueScale* and has undergone several versions based on the emergence of research (Figley, 1995; Figley & Stamm, 1996; Stamm, 2005). The ProQOLs seeks to assess both the positive and negative factors associated with ones' profession (Stamm, 2010). In addition, the ProQOLs was used with a wide variety of

professions (e.g., health care professionals, teachers, and social service workers) and has a large base of supporting literature (Stamm, 2010).

To score the ProQOLs, researchers first need to reverse score items 1, 4, 15, 17, and 29. Then, researchers sum the items for each subscale. Last, the Stamm (2010) recommends researchers convert the Z-scores into t-scores; however, not all researchers convert the scores (e.g., Lawson & Meyers, 2011). The norm group summed scores for the ProQOLs scales ($N = 967$) are: Compassion Satisfaction ($M = 37.00$, $SD = 7.30$), Burnout ($M = 22.00$, $SD = 6.80$), and Compassion Fatigue ($M = 13.00$, $SD = 6.30$). Stamm reported the following Cronbach's Alphas for the three subscales: Compassion Satisfaction (.88), Burnout (.75), and Secondary Traumatic Stress (.80). In addition, the three subscale intercorrelations are low, supporting the construct validity.

Psychometric properties of the ProQOLs. The ProQOLs was used in multiple studies that examine counseling practitioners. Lawson (2007) examined the career sustaining behaviors and ProQOL of 1,000 American Counseling Association (ACA) members. The study produced a 50.9% response rate ($N = 501$) with 88 participants who work in K-12 settings. The average scores on the three scales were: *Compassion Satisfaction* ($M = 39.84$, $SD = 6.43$, Alpha = .77); *Compassion Fatigue* ($M = 10.05$, $SD = 5.91$, Alpha = .85); and *Burnout* ($M = 18.37$, $SD = 6.00$, Alpha = .82). Lawson (2007) found that those participants in K-12 settings scored ($M = 19.70$, $SD = 6.29$) lower on the Burnout scale than their counterparts in community settings ($M = 19.84$, $SD = 6.88$), but higher than practitioners in private practice ($M = 15.77$, $SD = 6.04$), $F(5, 456) = 8.22$, $p = .000$. Additionally, K-12 practitioners scored ($M = 11.89$, $SD = 6.40$) higher in *Compassion Fatigue* when compared to private practitioners ($M = 8.26$, $SD = 5.25$) and practitioners in community settings ($M = 10.31$, $SD = 5.78$), $F(5, 456) = 5.78$, $p < .035$. There

were no group differences in *Compassion Satisfaction* scale scores. In addition, there were no significant differences in the ProQOLs scores and demographic factors.

In a separate study, Lawson and Meyers (2011) examined the levels of counselors' wellness, ProQOL, and career sustaining behaviors, the group's differences for these variables, and the relationships for these variables. The authors used paper pencil mail survey methods with 1,000 ACA members, which resulted in a 51.7% response rate ($N = 506$). Of the 506 participants, 20.6% work in K-12 setting. Importantly, the authors used the third version of the ProQOLs, yielding the following internal consistency coefficients: *Compassion Satisfaction* (.84), *Burnout* (.78), and *Secondary Traumatic Stress* (.80). Additionally, the third version of the ProQOLs produced the following mean scores: *Compassion Satisfaction* ($M = 40.52, SD = 5.57$), *Burnout* ($M = 19.93, SD = 5.96$), and *Compassion Fatigue* ($M = 10.32, SD = 5.98$). The authors concluded that counselors working with more clients/students with a history of trauma were at a higher risk for burnout. In addition, those counselors working with high-risk clients had higher levels of burnout and had lower levels of compassion satisfaction.

School Counselor Self-Efficacy Scale (SCSEs)

The *SCSEs* (Bodenhorn & Skaggs, 2005) is a self-report instrument that consists of 43-items, which is designed to measure the self-efficacy of school counselors. In addition, the *SCSEs* includes five subscales that measure school counselors' confidence to facilitate job roles, including: (a) personal and social development (12 items), (b) leadership and assessment (nine items), (c) career and assessment (seven items), (d) collaboration (11 items), and (e) cultural awareness (four items). The *SCSE* utilizes a five-point Likert scale (1 = Not Confident, 2 = Slightly Confident, 3 = Moderately Confident, 4 = Generally Confident, 5 = Highly Confident).

The SCSEs (Bodenhorn & Skaggs, 2005) was developed in four separate studies. The first study consisted of two steps. Initially, the authors reviewed the *National Standards for School Counseling* (Campbell & Dahir, 1997), the Council for Accreditation of Counseling and Related Educational Programs (CACREP, 2001) *Standards*, and established counseling based self-efficacy scales. The SCSEs initial item develop process resulted in the original 44 items, which was presented to a panel of five experts in school counseling, resulting in 51 items scale.

The second study included dissemination of the new SCSEs to 582 ASCA conference attendees through a survey by email, which resulted in 226 respondents (a 38.7% response rate; Bodenhorn & Skaggs, 2005). Eight items on the scale were initially deleted either due to a high degree of nonresponse by participants (an indicator of a confusing or poorly worded item) or poor discrimination (low variance in responses). The mean across all SCSE items was 4.21 ($SD = .67$, range = 3.50 to 4.85). The mean of the total SCSE scale score was 180.97 ($SD = 19.86$). In addition, the authors reported high item correlation. In examining group differences (using Analysis of Variance [ANOVA]), the authors found significant difference in the following areas: (a) participants' gender $F(1, 223) = 6.81, p < .05; R^2 = .03$ with females reporting stronger self-efficacy than males; (b) participants' teaching experience $F(1, 223) = 8.235, p < .01; R^2 = .04$ with participants with teaching experience having more self-efficacy; and (c) participants' experience as a school counselor $F(1, 220) = 7.04, p < .01; R^2 = .03$.

The third study was disseminated to counselor educators at 22 universities who administered it to 326 school counselors-in-training to with a 36% response rate ($N = 116$) (Bodenhorn & Skaggs, 2005). This study paired the SCSEs with other instruments to assess the construct validity by examining interment correlations. The other scales used included the *Counseling Self-Estimate Inventory* (COSE; Larson et al., 1995), the *Social Desirability Scale*

(SDS; Crowne & Marlowe, 1960), the *State-Trait Anxiety Inventory* (STAI; Spielberger, 1983), and the *Tennessee Self-Concept Scale* (TSCS 2; Fitts & Warren, 1996). The results identified the following relationships: (a) COSE ($n = 28$; $r = .41$, $p < .05$); (b) SDS ($n = 25$; $r = .30$, $p > .05$); (c) STAI; State ($n = 38$; $r = -.41$, $p < .05$), Trait ($n = 38$; $r = -.31$, $p > .05$); and (d) TSCS 2 ($n = 28$; $r = .16$, $p > .05$). These results supported concurrent validity of the SCSEs with instruments measure similar constructs; however, these result must be interpreted with caution.

The fourth study conducted to develop the SCSEs included the combination of all the data collected from study two and three for item analysis, which resulted in 342 total respondents (Bodenhorn & Skaggs, 2005). The authors used principal component analysis with a resulting eight-factor solution that accounted for 65% of the variance. Then, the authors reviewed the scree plot and examined the breaks, resulting in breaks after one, two, five, and eight. They tested each solution using an oblique rotation (e.g., direct oblimin) seeking to find the simplest structure that aligns with theory. The result of their investigation was a five-factor solution that accounted for 55% of the variance. The subscale coefficient alphas were: personal and social development (.91), leadership and assessment (.90), career and assessment (.85), collaboration (.87), and (e) cultural awareness (.72).

Psychometric properties of the SCSEs. The SCSEs (Bodenhorn & Skaggs, 2005) was used in multiple studies that support its validity and reliability with diverse samples. Bodenhorn, Wolfe, and Alren (2010) examined the relationship between school self-efficacy (using the SCSEs), school counselors' awareness and utilization of achievement gap data, and school counseling program choice. The study surveyed 1,600 ASCA members with a response rate of 54% ($N = 860$), and the coefficient alpha was .97. They found that school counselors' knowledge regarding program choice is related to their self-efficacy. In addition, Bodenhorn et al. (2010)

found that school counselors' with higher levels of self-efficacy have a higher likelihood to implement the ASCA *National Model* as compared to school counselors with lower levels of self-efficacy. Scoles (2011) surveyed 129 members of the Ohio School Counselors Association comparing the self-efficacy of members who held teaching experiences versus those who did *not* have prior teaching experience. The results identified differences in three of the subscales (e.g., Personal and Social Development, Leadership and Assessment, and Collaboration). The Cronbach's alphas for the SCSEs subscales in this study were as follows: personal and social development (.88), leadership and assessment (.90), career and assessment (.84), collaboration (.82), and (e) cultural awareness (.68) with an overall Cronbach alpha of .96.

School Counselor Activity Rating Scale (SCARS)

The *SCARS* was developed by Scarborough (2005) as a self-report instrument to measure the service delivery activities and roles of school counselors. The *SCARS* is a self-report measure that can be used to measure the practices of school counselors and serve as an accountability tool. The *SCARS* was developed due to two main factors: (a) the need to assess the effectiveness of school counselors and advocate for their role in schools and (b) the paucity of valid and reliable instruments to measure how counselors spend their time. Therefore, Scarborough developed the *SCARS* to assess preferred and actual job duties that are carried out by school counselors. The *SCARS* provides information on both how school counselors spend their time and the discrepancy between how they would like to spend their time and what they actually do.

The *SCARS* was developed in two steps. First, the Scarborough (2005) designed the task statements, rating scale, and format of the instrument. The task statements were derived from prescribed by the ASCA *National Model* (ASCA, 2003) to reflect the expected roles of school

counselors. SCARS items were selected to describe school counseling activities in five areas, including: (a) *counseling* (individual and group); (b) *consultation*; (c) *coordination*; (d) *curriculum* (e.g., classroom guidance lessons); and (e) *other activities* (e.g., activities that are *not* suggested by ASCA, 2003).

The second step in the development of the SCARS included a pretesting of the instrument. During the pretest, Scarborough (2005) assessed for production mistakes, readability, and understanding by conducting interviews with two individuals who took the scale, one took the scale in the presence of the interviewer and the other took it first and then provided input. Both forms of feedback provided the researcher with feedback to improve the SCARS. Next, the researcher had five colleagues (experts in school counseling) review the SCARS to provide additional feedback. Feedback from both groups guided the wording, style, and format of the scale.

The SCARS was tested with 50 total items (Scarborough, 2005). The researcher conducted an exploratory factor analysis study (principal components factor analysis; orthogonal transformation; varimax rotation). The sample consisted of 600 participants (100 per level – elementary, middle/junior high, and high school) from two southern states. Scarborough used *Tailored Design Method* survey to collect the data, resulting in a usable response rate of 60% with 117 elementary school counselors, 120 middle/junior high school counselors, and 124% high school counselors. In addition, the sample consisted of 89.7% females and 10.3% males. Regarding ethnicity, 10.7% were African American, .3% Asian American, 1.1% Native American, .6% Hispanic American, and 87.4% European American. Regarding age, the participants had an average 45.72 years of age ($SD = 10.02$). The average years of experience of

the participants was 11, including 27.9% of them having five or fewer years of age. In addition, 43.5% of the school counselors reported graduating from a CACREP Programs.

The results of the Scarborough's (2005) investigation supported a four-factor solution for both the *Actual* and *Preferred* scales for the original 40 items that measures the four main categories (e.g., *Counseling* [10 items], *Consultation* [7 items], *Coordination* [13 items], and *Curriculum* [8 items]; Scarborough, 2005). The reliability (Cronbachs Alpha) of these individual scales was as follows: (a) *Counseling* (Actual = .85; Preferred = .83), (b) *Consultation* (Actual = .75; Preferred = .77), (c) *Coordination* (Actual = .85; Preferred = .85), and (d) *Curriculum* (Actual = .93; Preferred = .90). Regarding the sub-scale for *Other School Counseling Activities*, the results support a two-factor solution; however, the author utilized a three factor solution to enhance the meaning of the subscales (Clerical [three items], Fair Share [five items] and Administrative [two items]). The reliability (Cronbachs Alpha) of these individual scales are as follows: (a) *Clerical* (Actual = .80; Preferred = .84), (b) *Fair Share* (Actual = .58; Preferred = .58), and (c) *Administrative* (Actual = .43; Preferred = .52). It is notable that both the Fair Share and Administrative scales produced low reliability ($> .60$; Tabachnick & Fidell, 2007), which merits caution with the interpretation of the results.

The author established the construct validity of the SCARS through the examination of group differences ($N = 360$) based on their school level (elementary, middle/junior high, and high school; Scarborough, 2005), which resulted in a significant difference between school levels. The author examined correlations between subscales and between the subscales and demographic factors (e.g., years of experience) to review discriminate validity, which resulted in two significant correlations between Coordination ($r = .21, p < .001$) and Consultation ($r = .19,$

$p < .001$) and years of experience; however, the results of the correlations suggest a small effect size (Cohen, 1988, 1992).

The resulting version of the SCARS consists of 48 items (Scarborough, 2005) that measures school counselor activities. Specifically, the SCARS has five subscales, including: (a) *Counseling* (10 items) - activities in which counselors provide individual and group counseling; (b) *Consultation* (seven items) - activities in which counselors working with stakeholder to meet student needs; (c) *Coordination* (13) - activities in which counselors manage, evaluate, and implement counseling programs; (d) *Curriculum* (eight items) – activities in which counselors facilitate classroom lessons; and (e) *Other Activities* (10 items) - activities in which counselors perform non-counseling tasks. Participants rate their Actual and Preferred activities on a five point Likert Scale in two spate columns. The rating scale (1-5 respectively) is as follows: (a) Never, (b) Rarely, (c) Occasionally, (d) Frequently, and (e) Routinely. Researchers can use both total scores (total score for each subcategory) and mean scores (e.g., divide the total number of item by the total score in each subscale). Participants who score higher indicate greater levels of engagement in the designated counselor activity. For this study, permission was requested to only obtain *Actual* score from participants.

Psychometric properties of the SCARS. The SCARS (Scarborough, 2005) was used in multiple studies that support its reliability and validity with diverse samples. For example, Clark (2006) examined school counselors' ($N = 118$) self-efficacy in relation to the *ASCA National Model* (2005) using the SCARS, and identified Cronbach Alpha scores ranging from .78 to .91. The results of Clark's study indicated that there is a relationship between the SCARS and the *School Counselor Self-Efficacy* (SCSEs; Bodenhorn & Skaggs, 2005) scale. In addition, Hebert (2007) used the SCARS with 305 school counselors to examine the time spent on specific tasks.

Herbert's Cronbachs Alpha scores ranges from .61 to .96, with coordination being the least reliable. Herbert reported that missing data contributed to the unreliability of coordination. Shillingford (2008) explored the relationship between school counselor activities (as measured by the SCARS; Scarborough, 2005), leadership qualities, and values. Her results indicated an overall Cronbachs Alpha score of .73 with the subscales ranging from .61 to .78. The findings of Shillingford's study indicated the successful leadership promotes the service activities they facilitate.

Research Design

This study employed a descriptive, correlational research design to examine the research hypothesis and exploratory questions. The goal of correlational research is to examine the relationship between two or more variables without the manipulation of variables (Gall et al., 2007). In addition, correlational research is used to determine the direction and strength of the relationship between variables (Graziano & Raulin, 2006). However, correlation does *not* indicate causation (Graziano & Raulin, 2006; Stanley & Campbell, 1963). Nonetheless, the use of descriptive, correlational research supports the examination of cause and effect relationships between constructs and predictive outcomes (Tabachnick & Fidell, 2007). However, to provide evidence of cause and effect relationships researchers must check for the presence of three necessary conditions, including: (a) the variables being measured are related, (b) proper time order, and (c) the relationship is no due to a confounding factor (Cook & Campbell, 1979; Johnson & Christenson, 2004). In correlational research, investigators should always look for alternative explanations for the relationships found in the data (Fraenkel & Wallen, 2009).

There exist potential threats to validity when using correlational research, including the following: (a) External Validity, (b) Internal Validity, and (c) Test Validity. External validity is

considered the generalizability of the results to other people, places, and setting (Campbell & Stanley, 1963; Gall et al., 2007; Fraenkel & Wallen, 2009). Within external validity, there are a few issues that may impact the results, including (a) ecological and (b) population validity.

Ecological validity refers to the extent to which the results can be generalized based upon the environmental conditions or across settings (Johnson & Christensen, 2004). For example, this research investigation took place during the fall semester of the school year; however, one may question whether the results would be different if it was conducted during the spring.

Unfortunately, there are limited precautions the researcher can take to prevent ecological factors from influencing the results. However, a replication of this study at a different time with a different sample of school counselors may support its conclusions.

Population validity refers to the extent in which the results from the sample can be generalized to the population (Johnson & Christensen, 2004). Moreover, population is related to the issue of *response bias*, in that the resulted may inaccurately represent those individuals who chose *not* to participate in the study (Johnson & Christensen, 2004). For example, a sample that is drawn from a population (or the participants who participated in the study) may *not* accurately represent the entire population being measured. This study used multiple samples (e.g., face-to-face administration – to obtain some participants who wouldn't normally participate; national samples of ASCA and non-ASCA members – to obtain group differences in results) with the goal of obtaining a comprehensive and diverse sample of the population. In addition, a sample with a 95% confidence level was selected to support its generalizability (Krejcie & Morgan, 1970). Furthermore, this study sought to circumvent barriers to increase the breathe of the *accessible population* (i.e., participants available for research).

Internal validity is the extent to which non-measured (e.g., extraneous) variables are accounted for or controlled (Campbell & Stanley, 1963; Johnson & Christensen, 2004). Moreover, internal validity supports our claim that there is a relationship between the dependent and independent variables (Johnson & Christensen, 2004); therefore, mitigating threats to internal validity is important in correlational research. The nature of correlational research results in a better understanding of relationships; however, causality cannot be inferred (Stanley & Campbell, 1963). Therefore, the results provide more information but further investigations would be required to understand causality.

In this study, the threats to internal validity include: (a) instrumentation, (b) self-report nature of the study, (c) characteristic correlation, (d) testing, (e) extraneous and confounding variables, and (f) mortality. Issues of validity related to instrumentation refer to the possibility that the instruments do *not* measure the construct accurately (Graziano & Raulin, 2006; Johnson & Christensen, 2004). Issues regarding instrumentation were addressed in two ways, including: (a) using sound instruments and (b) accounting for measurement error in the data analysis. Next, the self-report nature of the study is an inherent threat to internal validity that cannot be controlled for. For example, participants may just select (falsely) random responses to the instrumentation. Ways to account for false random responses are to include multiple measures (e.g., observational score); however, in this study this threat was *not* controlled. In addition, characteristic correlation is an internal threat of validity, which is the concern that a participant's characteristic accounts for a correlation between variables, *not* the construct being measured (Fraenkel & Wallen, 2009). Participant characteristic cannot be controlled; however, demographic characteristics were collected and examined for any unique relationships. Another threat to internal validity occurring when a response to one instrument or item impacts the response on other instruments or items

(Graziano & Raulin, 2006). For example, if participants take an instrument that challenges their knowledge (e.g., SCARS; Scarborough, 2005) they may report lower levels of confidence on a following instrument (e.g., SCSEs; Bodenhorn & Skaggs, 2005). This study could not account for the testing threat. Another threat to internal validity was extraneous variables (Gall et al., 2007), which refers to the concern that other variables (extraneous or variables that are *not* a focus of the study) influence the dependent variable. This study collected demographic information and examine any unique relationships with the goal of identify extraneous variables; however, some other variables are *not* measured may impact the results of the study.

In addition, mortality was a threat to internal validity (Fraenkel & Wallen, 2009). In mortality, participants may drop off or start but *not* complete a study (i.e., missing data; Fraenkel & Wallen, 2009), resulting in their voice *not* being present in the results. For example, it is logical to believe that participants (e.g., school counselors) who are *not* well, have *low* self-efficacy, or do *not* perform their duties may choose *not* to participate in the survey after viewing the items being measured. To reduce mortality, data was being collected from two separate samples: (a) in person administration, (b) online administration, and (c) mail survey. The in person administration *should* get more diverse (e.g., variances in dispositions) participant results. Additionally, the mail survey obtained a broader amount of participants (e.g., nation-wide).

Test validity is the soundness of inferences that are drawn from the instruments and assessments being measured (Reynolds, Livingston, Willson, 2010). Test validity includes (a) construct validity, (b) content validity, and (c) criterion validity. Construct validity refers to whether inferences drawn from an instrument measures represent the social construct being measured (Reynolds et al., 2010). Both convergent and discriminate validity are subcategories of construct validity. Convergent validity examines whether two measures in a construct that should

(theoretically) relate actually relate to one another whereas discriminate validity refers to whether two measures in a construct that should (theoretically) *not* relate actually do relate (Reynolds et al., 2010). In this study, the researcher supported the construct validity in two ways: (a) clearly defining the operational definitions of the constructs with a concise review of the literature (e.g., chapter two) and (b) conduct an exploratory and confirmatory factor analysis of each instrument associated with the measured social construct (Graziano & Raulin, 2006; Tabachnick & Fidell, 2007). Content validity refers to whether an instrument measures the entirety of an identified social construct (Reynolds et al., 2010). For example, if a measure of burnout only measures depersonalization, then it may *not* represent the full construct of burnout that also includes emotional exhaustion and reduced personal accomplishment. Criterion validity related to how well a variable (or multiple variables) is effective at predicting an outcome or indicator of a construct (Reynolds et al., 2010). Criterion validity includes (a) *concurrent validity* – simultaneously tested with similar instrument and produces the same results and (b) *predictive validity* – the ability of an instrument to predicts past or future outcomes (Reynolds et al., 2010). To support content and criterion validity, a thorough literature review was conducted that outlines the support of the instruments being used in the study. Additionally, in the analysis of the data, the instruments were compared to prior studies to assess the similarity.

Overall, in correlational research various threats to validity exist. Therefore, the researcher took precautions during the planning and implementation stages of the investigation to mitigate these threats to internal and external validity. The subsequent section presents the research hypothesis and exploratory research questions.

Research Hypothesis and Exploratory Questions

This study sought to examine the directional relationship between practicing school counselors' professional quality of life and self-efficacy in relation to their service delivery activities. This section of the chapter presents the primary research question, research hypothesis, and exploratory questions. In addition, the measurement and structural models used for the research hypothesis are provided (Figures 1 to 4).

Primary Research Question

Do practicing school counselors' levels of ProQOL (as measured by the *ProQOLs* [Stamm, 2010]) and their self-efficacy (as measured by the *SCSEs* [Bodenhorn & Skaggs, 2005]) contribute to their levels of service delivery (as measured by the *SCARS* [Scarborough, 2005])?

Research Hypothesis

School counselors' professional quality of life (as measured by the *ProQOLs* [Stamm, 2010]) and their self-efficacy (as measured by the *SCSEs* [Bodenhorn & Skaggs, 2005]) contributed to their service delivery (as measured by the *SCARS* [Scarborough, 2005]).

Specifically, this investigation tested the hypothesized directional relationship that practicing school counselors scoring at higher levels of ProQOL and higher levels of self-efficacy would have higher levels of service delivery.

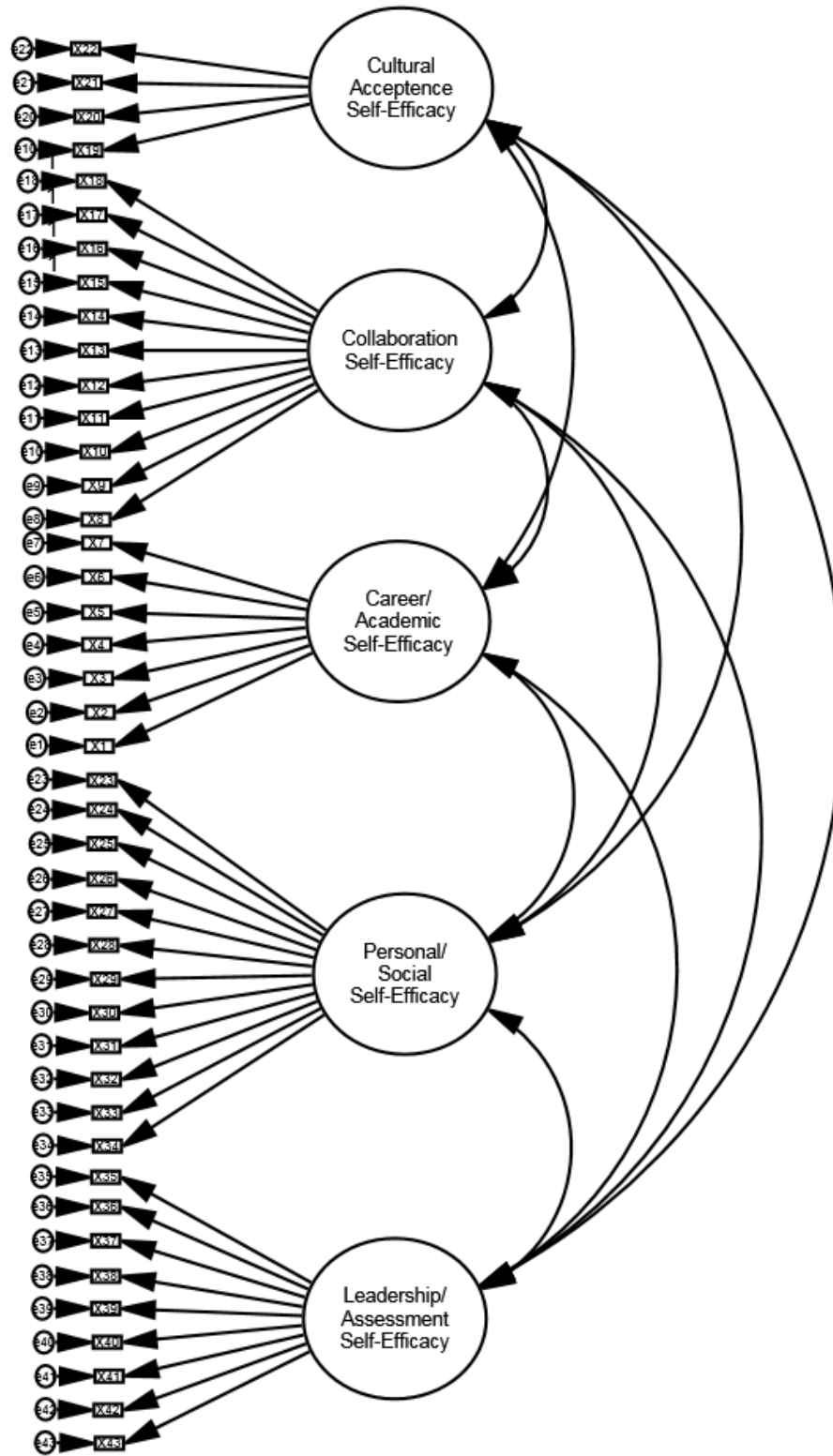

Figure 6: Measurement Model for the SCSEs (Bodenhorn & Skaggs, 2005)

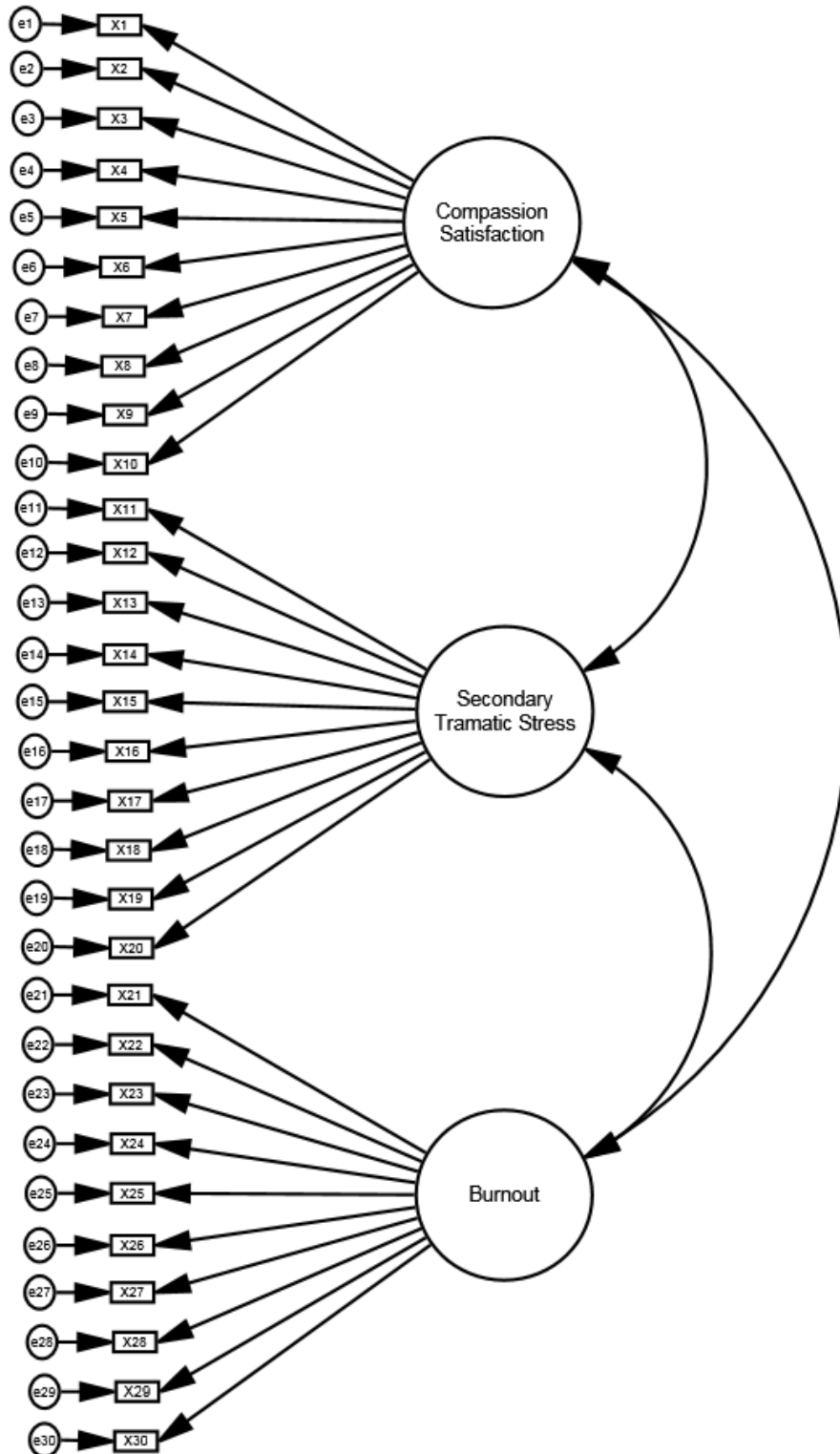

Figure 7: Measurement Model for the ProQOLs (Stamm, 2010)

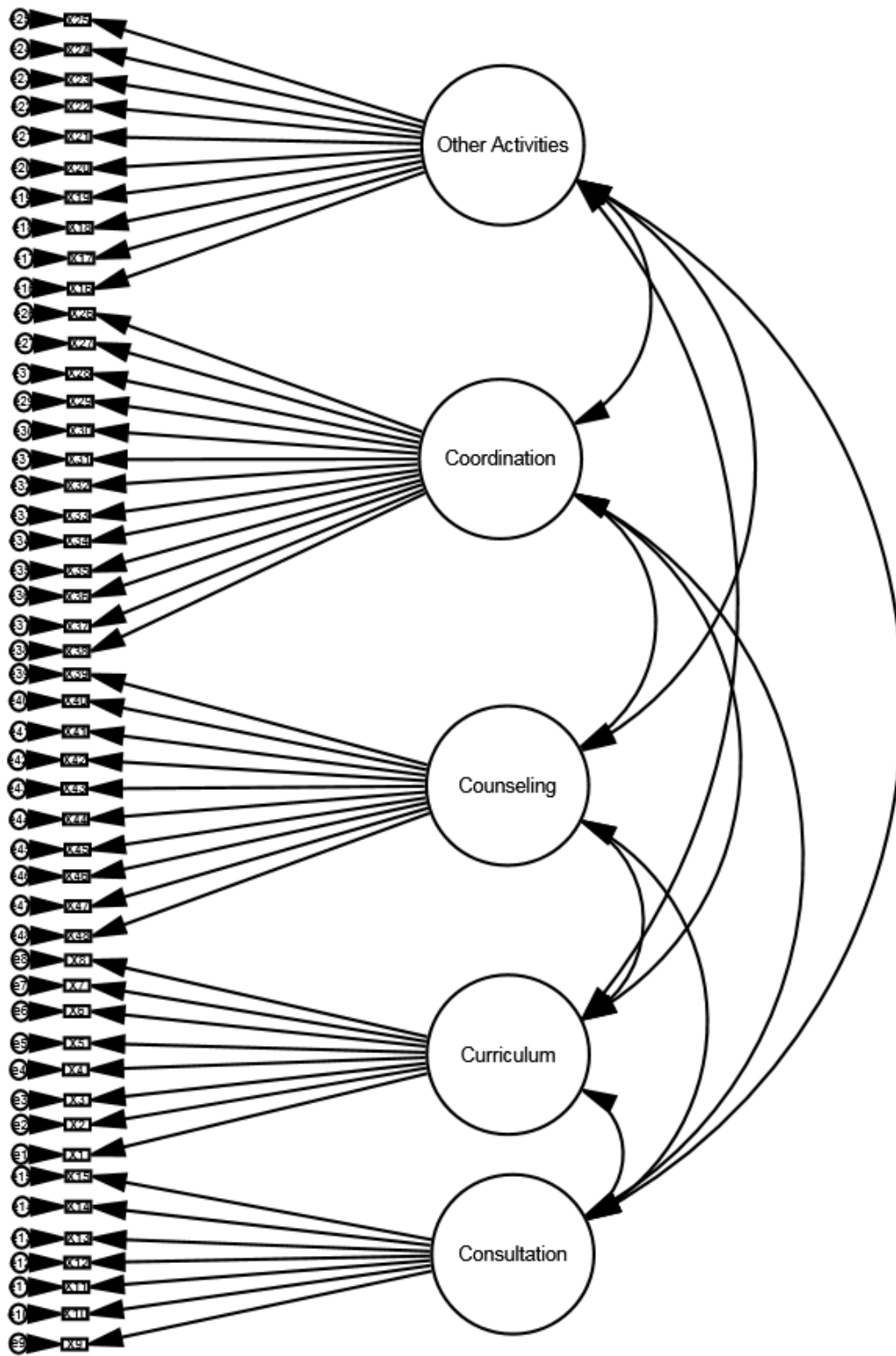

Figure 8: Measurement Model for the SCARS (Scarborough, 2005)

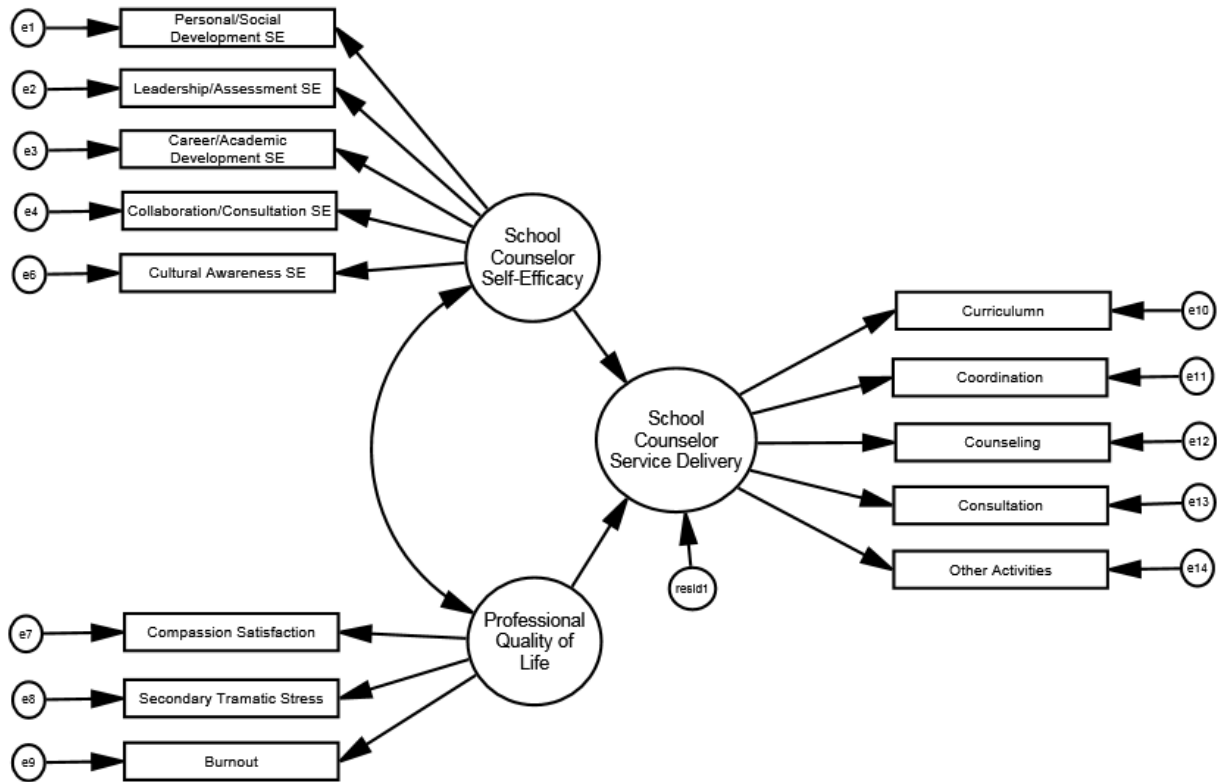

Figure 9: Path Diagram of the Structural Model to be Tested

Exploratory Research Questions

1. Is there a statistically significant relationship between schools counselors' levels self-efficacy (as measured by the SCSEs [Bodenhorn & Skaggs, 2005]) and their reported demographic variables (e.g., age, gender, and ethnicity)?
2. Is there a statistically significant relationship between practicing schools counselors' service delivery (as measured by the SCARS [Scarborough, 2005]) and their demographic variables (e.g., age, gender, and ethnicity)?
3. Is there a statistically significant relationship between practicing schools counselors' professional quality of life (as measured by the ProQOLs [Stamm, 2010]) and their demographic variables (e.g., age, gender, and ethnicity)?

4. Is there a statistically significant difference in practicing school counselors' total and subscale scores on the SCSEs (Bodenhorn & Skaggs, 2005), ProQOLs (Stamm, 2010), and SCARS (Scarborough, 2005) based upon the (a) sampling method (e.g., email web-based, paper-pencil mail-out survey, face-to-face survey administration), (b) token incentive type (e.g., monetary [\$1.00, \$2.00, or no incentive] or non-monetary [\$1.00 donation to the American Red Cross or no donation]), and (c) sampling population (e.g., professional association membership or no professional association membership)?

5. Is there a statistically significant difference in practicing school counselors' response rate (as measured by completion of the SCSEs, Bodenhorn & Skaggs, 2005; ProQOLs, Stamm, 2010; and SCARS, Scarborough, 2005) based upon the (a) sampling method (e.g., email web-based, paper-pencil mail-out survey, face-to-face survey administration), (b) token incentive type (e.g., monetary [\$1.00, \$2.00, or no incentive] or non-monetary [\$1.00 donation to the American Red Cross or no donation]), and (c) sampling population (e.g., professional association membership or no professional association membership)?

Data Analysis

The data analysis for this study was derived from three collection sources: (a) in person administration at multiple sites; (b) mixed-mode, mail out surveys to American School Counselor (ASCA) Members and identified school counselors from the Common Core Dataset; and (c) through email-online survey sent to ASCA member listed in the ASCA online directory. Participants completed the following instruments: (a) *general demographics form*, (b)

SCSEs (Bodenhorn & Skaggs, 2005), (c) *ProQOLs* (Stamm, 2010), and (d) *SCARS* (Scarborough, 2005). Data were collected in paper-pencil format or through an online survey and then inputted into Statistical Package Social Sciences (Version 20; SPSS, 2011). The data analysis used both SPSS (for data cleaning/management and Multiple Regression analysis) and Analysis of Moment Structures (AMOS; for Structural Equation Modeling [SEM] analysis) software program.

Initially, the data were cleaned (e.g., find and examine missing data). Listwise deletion method was used to clean the data (Tabachnick & Fidell, 2007). Next, the statistical assumptions were tested to ensure the appropriateness of the data for the desired analysis (i.e., SEM and Multiple Regression). Specifically, the researcher tested for normality, homogeneity, and multicollinearity. The section that follows described the data analysis that was used to test the research hypothesis and exploratory research questions.

Statistical Power

Power analysis is an important consideration when presenting the findings of SEM. Specifically, the power of a statistical analysis is the probability of rejecting the null hypothesis when the alternative hypothesis is true (e.g., likelihood that that a Type II error is not being committed) based upon the effect size, sample size, and alpha level for the analysis (Balkin & Sheperis, 2011). Statistical power for testing a SEM “is a function of N (sample size), d (degrees of freedom), ϵ^0 (RMEA under H^0), and ϵ^1 (RMEA under H^1), and critical value χ^2_c corresponding to a given α (significance level)” (Lee, Cai, & MacCallum, 2012, p. 191). For this study, power was reported based on MacCallum and colleague’s (1996) chart that indicates power levels derived from degrees of freedom and sample size of the model. The final useable sample size achieved was 577, which indicated high power ($> .80$) for analysis (Gall et al., 2007; MacCallum et al., 1996).

Research Hypothesis

This study employed correlational data analysis. Specifically, SEM (also known as Latent Variable Modeling) was used to analysis the two research hypothesis. SEM is “a sophisticated method of multivariate correlational research” that “can be used to test theories of casual relationships” (Gall et al., 2007, p. 371). In addition, Tabachnik and Fidell (2007) state that SEM “is a collection of statistical techniques that allow a set of relationships... to be examined” (p. 681). SEM is a combination of both *multiple regression analysis* and *exploratory factor analysis* and is used to examine the directional relationships of the variables being measured (Tabachnick & Fidell, 2007). However, SEM is a confirmatory approach that is used to test a theory (Tabachnick & Fidell, 2007).

This study used SEM to test a theoretical model that contains both manifest and latent variables. Manifest variables are the direct observations as measured by the scales (Schumacker & Lomax, 2010). Latent variables are the theoretical constructs that are formed by the manifest variables (Schumacker & Lomax, 2010). In this study, the latent variables are school counselor self-efficacy, ProQOL (e.g., mental and physical ProQOL), and school counselor service delivery. The investigation’s manifest variables consist of parcels comprised of individual items from the data collection instruments. Parceling is “an aggregate-level indicator comprised of the sum (or average) of two or more items” (p. 152) and is used to simplify complex structural models by reducing the required number of parameters need to obtain a fit model (Little, Cunningham, Shahar, & Widaman, 2002). However, some scholars suggest it disguises the true meaning of the parameter estimates and may lead to an increased potential for a misspecified model (Little et al., 2002). Nonetheless, this investigation uses parceled indicators due to the complexity of the measurement models. In SEM, arrows represent the directionality of the relationship; with a two way line representing correlated items. Manifest variables (i.e., direct

observations) are represented with squares and circles represent latent variables. A unique contribution of SEM is the dual model function. Specifically, SEM consists of a measurement model (e.g., confirmatory model) and a structural model (Schumacker & Lomax, 2010). The measurement model focuses on the manifest variables that contribute to the latent variables, resulting in the ability to test each instrument and make modifications that strength it (Schumacker & Lomax, 2010). The measurement model identifies the hypothesized relationships (Schumacker & Lomax, 2010). Another unique contribution that SEM offers is the ability to account for measurement error; that is, the relationships in SEM are free of measurement error (Schumacker & Lomax, 2010).

SEM requires that the following assumptions are met: (a) linearity, (b) absence of multicollinearity and singularity, (c) multivariate normality and outliers, and (d) residuals should be centered or close to zero (Tabachnick & Fidell, 2007). Additionally, all data must be cleaned and missing data must be addressed before using SEM. SEM has five steps that should be followed, including: (a) specification, (b) identification, (c) estimation, (d) evaluation, and (e) modification (Bryne, 1998; Crockett, 2012; Schumacker & Lomax, 2010; Tabachnick & Fidell, 2007). The following section of the chapter presents these five steps in greater detail (Crockett, 2012; Schumacker & Lomax, 2010):

1. *Model Specification* – The process of developing a theoretical model of relationships based upon prior knowledge of the individual constructs, occurring prior to any data analysis and results in a visual diagram (Schumacker & Lomax, 2010). The researcher must develop a plausible explanation for the relationships in the model (Crockett, 2012). Additionally, during model specification the researcher determines whether the parameters are *fixed* (e.g., no relationship between variables) or *free* (e.g., estimated from the data).

2. *Model Identification* – The process that determines whether or *not* the specified model is capable of obtaining a unique value for *all* of the free parameters from the observed data. In other words, model identification seeks to find out “whether or not there is a unique set of parameters are consistent with the data” (Bryne, 1998, p. 28). The specified model is identified and tested to see if it is able to produce parameter estimates and distinct results (Crocket, 2012). Both the measurement model and structural model must be identified with the measurement model needing to be identified first.
- a. The measurement model (e.g., the relationships between observed scores and latent variables) is tested through the use of confirmatory factor analysis (CFA). CFA empirically tests an *a priori* theoretical model of observed variables in relationship to a latent variable, which allows multiple items (e.g., indicators) to correlate to a single latent variable (Tabachnick & Fidell, 2007). Individual factor loadings of the observed variables indicate their contribution to the latent variable; therefore, it necessitates that factor loadings have a significant contribution to be included in the model. A factor loading of 0.32 is poor, 0.45 is fair, 0.55 is good, 0.63 is very good, and 0.71 is excellent (Comrey & Lee, 1992; Tabachnick & Fidell, 2007). However, a minimum cut-off of 0.40 is suggested (Stevens, 1992). The separate latent variables are then tested in the *a priori* theoretical structural model, which allows researchers to test the contribution of the latent variables to one another in a theoretically driven manner (Bryne, 1998; Schumacker & Lomax, 2010). The measurement model’s identification can be established through the use of O’Brian’s (1994) rules.
 - b. The structural model (e.g., the relationships between the latent variables) is a path diagram that consists of the combined latent variables from the separate measurement

models. The structural model is developed based upon an intense review of the literature and is a theory driven model. Researchers can test the relationships and contribution of the latent variables. The structural model's identification can be established through the use of Bollen's (1989) recursive rule and *t* rule.

3. *Model Estimation* – The process of examining values of “unknown parameters and the error associated with the estimated value” (Weston & Gore, 2006, p. 737). Model estimation “involves estimating the parameters of the theoretical model in such a way that the theoretical parameter values yield a covariance matrix as close as possible to the observed covariance matrix” (Crockett, 2012, p. 38). Iterative procedures seek to improve the initial parameter estimates using calculation cycles. The resulting parameter estimates represent the best fit to the observed covariance matrix. Researchers select a fitting function to use (e.g., Maximum likelihood [ML], Generalized Least Squares [GLS]), with ML being the most common approach (Crockett, 2012).
4. *Model Testing* – The process of analyzing the fit (e.g., Goodness-of-Fit) of both the measurement and structural models to verify the support of the sample variance-covariance data (Crockett, 2012; Schumacker & Lomax, 2010). Model testing examines both (a) global fit (e.g., entire model) and (b) individual model parameters fit. To examine fit, researchers examine the Chi-square Statistic (want *non-significance*) and standalone fit indices for the model (e.g., Comparative Fit Index [CFI]; Root Mean Squared Error of Approximation RMSEA]; Goodness-of-Fit Index [GFI]; and Standardized Root Mean Squared Residual SRMSR]; Fan & Sivo, 2005; Hu & Bentler, 1999). Table 3 present a description of the fit indices, including their cutoff criteria.

5. *Model Modification* – The process of modifying the theoretical model to enhance model to data fit (Schumacker & Lomax, 2010). While SEM is a *confirmatory* practice (e.g., pre-set model testing; Bryne, 1998), model modification is an *exploratory* procedure that involves the use of theory trimming and the introduction of new parameters with the aim to improve the model's fit to the data (Crocket, 2012). Modified models should be replicated with new samples to validate their results.

Further Breakdown of Steps in SEM

1. Formulate a theoretical model based upon a thorough understanding of the literature and research on the constructs of interest.
2. Examine and adjust measurement models through the use of CFAs (e.g., examine factor loadings and make adjustments as necessary).
3. Examine the parameters of the structural model by reviewing:
 - a. The signage (e.g., positive or negative values) and value of the parameters
 - b. Disproportionately large or small standard errors, which reflects the precision of the parameter estimate
 - c. Critical ratio (must be greater than ± 1.96 based on a probability level of .05)
4. Check the Chi-Square Statistic and standalone fit indices (e.g., CFI, RMSEA, GFI, SRMR, Fan & Sivo, 2005).
5. Modify the initial model through altering (e.g., setting or freeing) parameters.

Table 3 *Description of Fit Indices*

Fit Indices	Description	Cutoff Criteria
Chi-Square (χ^2)	Examines the comparison of the observed covariance matrix and predicted covariance matrix with the goal of verifying that the model predicts the matrix.	If the χ^2 is not significant, the model is acceptable.
Comparative Fit Index (CFI)	Examines the comparison of the ratio between the discrepancy of the hypothesized model to the discrepancy of the alternate model. The alternate model being derived from making latent variables and indicators uncorrelated. Least sensitive to sample size.	Greater or equal to .95
Root Mean Squared Error of Approximation (RMSEA)	Examines the amount of variance within the hypothesized model. Good fit index for models with few parameters and is sensitive to <i>df</i> .	Less than or equal to .08
Goodness of fit Index (GFI)	Examines the actual variance and covariance. Used as an alternative to chi-square.	Greater than or equal to .90
Standardized Root Mean Squared Residual (SRMR)	Examines the standardized difference between the observed and predicted correlation and is an absolute measure of fit.	Less than or equal to .06

Chart adopted from Fan & Sivo, 2005; Hu & Bentler, 1999; MacCallum et al., 1996

Statistical Methods used to examine Exploratory Research Questions One, Two, and Three

Exploratory research question one, two, and three were studied using several statistical analyses. First, the researcher examined the descriptive statistics. Then, the researcher examined the independent correlations (e.g., relationships) between the constructs (school counselor self-efficacy, ProQOL, and service delivery) and demographic factors (e.g., age, gender, ethnicity, level of education, length of experience as a school counselor, length of experience as a school counselor, and student caseload) using Pearson Product Moment Correlations. Next, multiple linear regression (MLR) analysis was employed to examine if the demographic variables

predicted the constructs of interest (outcome variables). Furthermore, analyses of variances (ANOVA) was employed to examine possible mean difference in the school counselors' scores on the data collection instruments (SCSEs, ProQOL, and SCARs) by their demographic data (e.g., gender, school level).

Statistical Methods used to examine Exploratory Research Questions Four and Five

The exploratory questions four and five employed multiple methods of data analysis. First, unit nonresponse rate (total possible response - total completed response = unit nonresponse rate) were calculated based on data collection method, sample population, and incentive type. Then, mean scores on the SCSEs, ProQOLs, and SCARS were compared using several ANOVAs with data collection method, sample population, and incentive type as the separate grouping variables. Post hoc tests were used if significant was found. Furthermore, separate logistic regression analysis by data collection method and sampled population were used to predict participant's tendency to response based on demographic factors and incentive type.

Dependent and Independent Variables

Dependent/Endogenous Variable

School counselor service delivery was the dependent variable that represents the enactment of the roles and responsibilities of school counselors by the participants' (Scarborough, 2005). School counselor service delivery was chosen as the dependent variable because based on a review of the literature it appears to be the criterion that is theoretically most affected by the independent variables (i.e., self-efficacy and ProQOL) as they are manipulated.

Independent/Exogenous Variables

The independent/exogenous variables in this study were derived from a comprehensive review of the literature that supported their effect on school counselor service delivery. The independent/exogenous variables are:

1. **Professional Quality of Life:** The construct of professional quality of life (as measured by the ProQOLs [Stamm, 2010]) was chosen as an independent variable because it may theoretically influence one's job productivity (e.g., service delivery), as noted in Chapter Two. Professional Quality of Life consists of three subscales: compassion fatigue, burnout, and compassion satisfaction. In addition, this is a latent variable because the ProQOLs dedicates 30 items (10 items per subscale) that represent manifest variables for professional quality of life.
2. **School Counselor Self-Efficacy:** The construct of self-efficacy (as measured by the SCSEs [Bodenhorn & Skaggs, 2005]) was chosen as an independent variable because it was empirically shown to influence school counselors' service delivery, as noted in Chapter Two. In addition, this is a latent variable because the SCSEs consist of five subscales (e.g., *Personal Social Self-Efficacy*, *Career and Academic Self-Efficacy*, *Leadership and Assessment Self-Efficacy*, *Collaboration Self-Efficacy*, and *Cultural Acceptance Self-Efficacy*) that form the latent variable of school counselor self-efficacy.
3. **Demographic Variables:** The demographics variables were included as independent variables, including: (a) age, (b) ethnicity, (c) gender, (d) experience as a teacher, (e) experience as a school counselor, (f) education level, and (g) student case load. These demographic variables were chosen based on a review of the literature (see Chapter Two) to reflect various factors that influence school counselor service delivery.

Ethical Considerations

The ethical considerations that were considered by the IRB and the researcher's dissertation committee include the following:

8. Participants' data was collected *anonymously* and secured to protect confidentiality.
9. Participation in this study was voluntary and did *not* have an impact on participants' employment.
10. Participants were informed of their rights as participants of this study.
11. Participants were able to withdraw at any time from the study without consequence or retribution.
12. Participants were given an Explanation of Research that was approved by the IRB.
13. The researcher obtained permission to use all of the instruments used in this study prior to collecting data.
14. The researcher conducted this study after obtaining permission and approval from the dissertation chairs, the committee members, the individual school districts, and the IRB at the University of Central Florida.

Study Limitations

Several limitations exist for this study. First, the research being conducted is correlational; thus, causality cannot be concluded from the results (Stanley & Campbell, 1963). In addition, correlational research is susceptible to the threats to validity, including: external validity, internal validity, and construct validity (as noted). Furthermore, the data being collected is self-report and may *not* be the most accurate measure for the constructs. Moreover, part of the sample is convenient, which may *not* be inclusive of all school counselors. As well, the survey

packets contain four collection forms with a large amount of item that participants are asked to answer. Hence, the length of the packet may contribute to non-response bias.

Chapter Three Summary

This chapter presented the methodology used for this research study. This study investigated a current void in the research, as discussed in Chapter Two. Specifically, the investigation sought to test a theoretical model that school counselors' professional quality of life (as measured by the ProQOLs [Stamm, 2010]) and self-efficacy (as measured by the SCSEs [Bodenhorn & Skaggs, 2005]) positively contribute to their service delivery activities (as measured by the SCARS [Scarsborough, 2005]). The research methods described in this chapter includes the following: (a) population and sampling procedures, (b) data collection methods, (c) study instrumentation, (d) research design/method, (e) research hypothesis and exploratory questions, and (f) data analysis methods. In addition, the chapter outlined the dependent and independent variables, ethical considerations, and limitations.

CHAPTER FOUR: DATA RESULTS

Chapter four presents the results of the research hypothesis and exploratory questions that were investigated in this study. The purpose of this investigation was to examine the directional relationship between practicing school counselors' level of professional quality of life and self-efficacy to their programmatic service delivery activities. This investigation tested the theoretical model that practicing school counselors' level of professional quality of life (as measured by the *Professional Quality of Life Scale* [ProQOLs; Stamm, 2010]) and their self-efficacy (as measured by the *School Counselor Self-Efficacy Scale* [SCSEs; Bodenhorn & Skaggs, 2005]) contribute to their programmatic service delivery activity (as measured by the *School Counselor Activity Rating Scale* [SCARS; Scarborough, 2005]). Specifically, this study examined the hypothesized directional relationship that school counselors who report higher scores in ProQOLs (e.g., less burnout and compassion fatigue and higher compassion satisfaction) and report higher levels of school counselor self-efficacy (e.g., more confident about counseling skills) would report increased levels of programmatic service delivery facilitation (e.g., they do more school counseling activities for students and stakeholders). In addition, this study investigated the relationship between the school counselors' self-reported demographic variables (e.g., ethnicity, age, and years of school counseling experience) and their self-reported professional quality of life, school counselor self-efficacy, and service delivery independently. Furthermore, this study explored survey research methodology by comparing: (a) data collection methods, (b) sampling methods, and (c) incentive types.

The research hypothesis was analyzed using *Structural Equation Modeling* (SEM). The exploratory research questions were analyzed using: (a) Multiple Linear Regression (MLR), (b) Spearman Rho correlation, (c) Mann-Whitney U test, (d) Kruskal-Wallis H test, and (e) Chi-

Square test of independence. Effect sizes were calculated for the Mann-Whitney U Tests and Kruskal-Wallis tests by using post-hoc analysis (Mann-Whitney: $r = Z/\sqrt{N}$; Kruskal-Wallis: $\eta^2 = \chi^2/N-1$). The results are presented in this chapter in the following order: (a) sampling and data collection procedures, (b) descriptive statistics used to examine the demographic data, and (c) data analysis per the research questions (primary and exploratory).

Sampling and Data Collection Procedures

This investigation examined practicing school counselors who work in educational (school) settings with students ranging from grade levels of kindergarten to 12th grade (e.g., elementary, middle/junior high school, and high school). This study did *not* include participants that were school counselor trainees, administrators, or counselor educators. According to the Common Core Data from the Federal Department of Education (<http://nces.ed.gov/ccd/>), there were 105,078 school counselors nationwide during the 2010-2011 school year (most recent available school year). Consequently, to generalize the results to *all* practicing school counselors in the United States (U.S.) with a 95% confidence level, a minimum random sample of 384 school counselors was required (Krejcie & Morgan, 1970).

The researcher acquired participants in several manners. First, a convenience sample of participants was selected to complete the study in a face-to-face administration. This sample included two school districts in separate states in the southern part of the U.S. The researcher identified and contacted 10 school districts based on diverse school context (e.g., size, location), geographical location, and feasibility (e.g., researcher's financial and time availability). Of the 10 school districts the researcher contacted; two school districts responded with an interest in participating in the investigation with an estimated 200 potential school counselor-participants. Second, the researcher utilized the online directory of the American School Counselor

Association's (ASCA) online directory. The online directory included approximately 24,000 contacts, which include *all* membership classes (e.g., students, practicing school counselors, counselor educators, and administrators). Participants were screened to assure they were practicing school counselors. A simple random sample of 3,000 potential participants was selected from this group. Third, the researcher accessed the Common Core Data list of *all* K-12 schools in the U.S. and used simple random sampling (via Excel) to select 300 schools. Then, the researcher visited the website of each of the 300 schools to identify a school counselor to select as a potential participant. To limit bias in the participant selection process, the researcher randomly selected the school counselor (via Excel) from *all* counselors in each of the 300 schools. Fourth, the researcher contacted ASCA to acquire the mailing addresses of practicing school counselors who hold membership in ASCA. The researcher requested 2,000 (minimum amount available for request) randomly selected ASCA members whose membership status was professional and worked as a school counselor (*not* school counselor trainees, counselor educators, or administrators). Of the 2,000 identified ASCA members, the researcher used simple random sampling to select 300 to invite to participate. In summary, the researcher identified a convenience sample of school counselors (two school districts) and simple random sample of school counselors (ASCA Members and General Practicing School Counselors) to invite to participate in this study. Therefore, 3,800 practicing school counselors (e.g., 3,000 ASCA Online Directory, 300 ASCA Membership List, 300 Common Core Data List, and 200 Face-to-Face) were invited to participate in this study.

First, the survey was administered face-to-face by the researcher at the school counseling professional development meetings of the two school districts during the Fall 2013 school year. Each potential school counselor was invited to participate in the study (e.g., informed consent;

General Demographics Form; *ProQOLs* [Stamm, 2010]; *SCSEs* [Bodenhorn & Skaggs, 2005]; and *SCARS* [Scarborough, 2005]) and had the opportunity to opt out or *not* participate at any time in the investigation. Participants received a large envelope that included all the data collection instruments. If the school counselors participated, they completed the instruments and returned a sealed envelope. Envelopes were kept sealed until the researcher began data entry. Participants in this data collection method did *not* receive an incentive.

The next method of data collection utilized was a mixed-method, where the school counselors were mailed a data collection packet to complete. Specifically, the following steps were taken: (a) participants were mailed an initiation invitation letter and instrument packet (e.g., informed consent; General Demographics Form; *ProQOLs* [Stamm, 2010]; *SCSEs* [Bodenhorn & Skaggs, 2005]; and *SCARS* [Scarborough, 2005]); (b) participants were mailed a reminder/thank you post card after one week; (c) non-respondent participants were mailed another instrument packet after two weeks; and (d) non-respondent participants were mailed a final request to participate after three weeks. Participants had the option to complete the survey online (www.counselorsurvey.net) or by returning the instrumentation packet. Participants were assigned a *personal access code* to use when completing the survey to support their anonymity. Participants in the mailed a data collection method received one of the following incentives: (a) *no* incentive, (b) a \$1.00 bill, or (c) a \$2.00 bill. The allocation of incentive was randomly assigned (via Excel).

The third method for sampling was email/web-based survey, which followed the *Tailored Design Method* (Dillman et al., 2009). Participants randomly selected from the ASCA online membership directory were invited to participate via email. The data collection packet was converted into an online survey using Qualtrics.com. Each participant received emails through

Qualtrics.com. The first email the school counselors received included: (a) an introduction to the study, (b) a link to participate, and (c) information regarding the IRB approval. The second email the school counselors received was a reminder email for non-respondents. The third email the school counselors received was another email for non-respondents. Participants either did *not* receive an incentive or a donation of \$1 was made to the American Red Cross on their behalf. The allocation of incentive was randomly assigned (via Excel).

Descriptive Data Results

The following sections reviews the response rate based upon sampling methodology. Table 4 presents the response rate in graph form.

Response Rate

Face-to-face data collection. Two school districts in the Southeastern U.S. volunteered to participate in this investigation. To measure response rate, the researcher examined the amount of data collection packets distributed versus the number of data collection packets completed. In district A, 171 packets were distributed with 155 being returned that were started (90.46% response rate). Of the 155 returned data collection packets, 147 were completed (85.96% usable response rate). In district B, 65 data collection packets were distributed with 65 being returned that were started (100% response rate). Of the 65 data collection packets returned, 61 were completed (93.85% useable response rate). Across both school districts, 236 data collection packets were distributed and 220 were returned that were started (93.22% response rate). Of the 220 returned data collection packets, 208 were fully completed (88.13% useable response rate).

Paper-pencil mail out. The researcher tracked the response rate for the paper-pencil mail out data collection packets using Excel. The original sample of participants included 600

practicing school counselors from the populations of ASCA membership and Common Core Database. For the ASCA membership sample, six participants *no* longer qualified for the study, resulting in 294. Of the potential 294 participants, 140 returned packets (47.61% response rate). Of the returned packets, 139 were completed (47.28% useable response rate). For the Common Core Data list sample, two participants *no* longer qualified for the study, resulting in 298. Of the potential 298 participants, 150 counselors returned packets (50.33% response rate). Of the returned data collection packets, 148 were completed (49.66% useable response rate). Across both the ASCA and Common Core Database samples ($N = 592$), 290 school counselor-participants returned packets (49.00% response rate). Of the returned packets, 287 data collection packets were completed (48.48% usable response rate).

Email/web-based. School counselor-participants were randomly selected to participate based on their choice to post their contact information in the ASCA online membership directory. Individuals from the ASCA online directory who participated in the study were screened by using an initial question at the start of the survey that asked about their current position. If they did *not* answer that they are currently working as a school counselor, they did *not* complete the survey and they were redirected to the end of the survey. Of the 3,000 potential participants, 34 indicated they were currently in another profession (e.g., student, counselor educator, administrator, and unemployed) other than school counseling. From the remaining 2,966, 341 participants visited and started the survey. Of those participants who visited the survey, 195 completed the all the data collection instruments (57.18% response rate for participants who started the survey), which resulted in a usable response rate of 6.57% response. In email/web-based surveys, the response rate is challenged by limited knowledge of the whether or *not* the email addresses are correct and work for the participant (Granello & Wheaton, 2004).

Therefore, the actual response rate may be higher than what is reported due to some potential participants *never* receiving the invitation to participate.

Total useable response rate. In total, 3,795 practicing school counselors were invited to participate in this study with a total useable response rate of 18.19% ($N = 690$). The number of participant response that was random (e.g., ASCA Membership, Common Core Data list, and ASCA Online Directory; $n = 482$) met the needed sample size of 384 to have a 95% confidence level (Krejcie & Morgan, 1970). In addition, the convenience sample ($n = 208$) was included. Furthermore, the 690 school counselors completing the data collection instruments were an adequate sample size for the data analysis being used (SEM; Schumacher & Lomax, 2010).

Table 4 *Sampling and Data Collection Methodology*

Data Category	Total (<i>n</i>)	Response Rate
Sample Group ($N = 690$)		
ASCA Membership List	139	47.3%
Common Core Data List	148	49.7%
ASCA Online Directory	195	6.6%
Identified School Districts (two)	208	88.1%
Data Collection Method ($N = 690$)		
Paper-Pencil Mail Out	287	48.5%
Email/Web-Based	195	6.6%
Face-to-Face	208	88.1%

The descriptive data and measures of central tendency for *all* of the participants ($N = 690$) are presented in the following section. The descriptive data in presented in three groups, including: (a) participant characteristics (table 5), (b) school characteristics (table 6), and (c) Likert demographic items (tables4-18).

Participant Characteristics

The participants' ($N = 688$) reported gender consisted of 545 females (79.0%) and 143 males (20.7%) with two (.3%) respondents *not* reporting gender. The reported ethnicity of the

participants ($N = 686$) was 407 (68.7%) White, 107 (15.5%) African-Americans, 70 (10.1%) Other Ethnicity, 15 (2.2%) Hispanic, 12 (1.7%) Multiracial, 6 (0.9%) Native-Americans, 1 (0.1%) Asian American, and 1 (0.1%) Pacific/Islander with 4 (0.5%) respondents *not* reporting ethnicity. The reported average age of respondents ($N = 679$) was 43.2 years ($SD = 11.18$, Range = 24 to 74, $Mdn = 42$, Mode = 34).

Regarding preparation, participants' ($N = 684$) reported that 548 (79.6%) earned a Master's Degree, 91 (13.2%) earned an Educational Specialists, 14 (2.0%) Doctorate of Educations, 14 (2.0%) earned a Doctorates of Philosophy, and 2 (0.3%) earned a Bachelor, with 6 respondents *not* reporting highest earned degree. Furthermore, of the reporting participants ($N = 684$), 451 reported attending or they attended a CACREP accredited program for their counselor preparation, 95 (13.8%) did *not* attend a CACREP program for their school counselor preparation, and 137 (19.9) indicated they did *not* know if they attended a CACREP program for their counseling preparation, with 4 (0.5%) participants *not* responding. The average number of *years of experience as a school counselor* of respondents ($N = 689$) was 10.38 years ($SD = 7.59$, Range = 0 to 39, $Mdn = 8$, Mode = 7), with 17 (2.4%) participants in their first year as a school counselor. The average number of *years of experience as a teacher* of respondents ($N = 691$) was 4.73 years ($SD = 6.95$, Range = 0 to 42, $Mdn = 1$, Mode = 0), with 314 (45.5%) participants having never worked as a teacher. Regarding membership in ASCA, 469 (68.4%) of respondents ($N = 686$) were members at the time of completing the data collection instruments with 217 (31.6%) *not* being members, and 4 (0.5%) *not* reporting their membership status. Within the subgroup of participants who were *not* a member of ASCA at the time of the data colleciton ($N = 217$), 92 (42.4%) were a member of ASCA in the previous five years and 125 (57.6%) were *not* a member of ASCA in the previous five years. Additionally, of the subgroup of participants who

were *not* a member of ASCA at the time of the data collection ($N = 217$), 81 (38.2%) reported that membership cost too much/cannot afford it, 52 (24.5%) reported membership in another organization, 38 (17.9%) reported that membership is *not* worth it/limited benefits, and 41 (19.3%) reported that there were other reasons for *not* having membership in ASCA.

Table 5 *Categorical Demographic Variables – Participant Characteristics*

Data Category	Total (<i>n</i>)	Percentage
Gender (<i>N</i> = 688)		
Female	545	79.0%
Male	143	20.7%
Other	0	0%
Ethnicity (<i>N</i> = 686)		
African-American	107	15.5%
Asian American	1	0.1%
Hispanic	15	2.2%
Multiracial	12	1.7%
Native-American	6	0.9%
Pacific/Islander	1	0.1%
White (Non-Hispanic)	474	68.7%
Other	70	10.1%
Degree Level (<i>N</i> = 684)		
Bachelor's	2	0.3%
Master's	548	79.6%
Educational Specialist	91	13.2%
Doctorate of Philosophy	14	2.0%
Doctorate of Education	14	2.0%
Other	14	2.0%
Was your counseling training program CACREP Accredited? (<i>N</i> = 684)		
Yes	452	65.5%
No	95	13.8%
I don't know	137	19.9%
Are you a member of ASCA? (<i>N</i> = 686)		
Yes	469	68.4%
No	217	31.6%
If <i>not</i> a current member, were you a member of ASCA in the past 5 years? (<i>N</i> = 217)		
Yes	92	42.4%
No	125	57.6%
Reasons for <i>not</i> holding membership in ASCA (<i>N</i> = 217)		
Cost too much/cannot afford it	81	38.2%
Not worth it/limited benefit(s)	38	17.9%
I am a member of another organization	52	24.5%
I have never heard of ASCA	0	0%
Other	41	19.3%

School Characteristics

The school counselor respondents' ($N = 686$) reported school levels include: (a) 215 (31.2%) at the elementary school level, (b) 195 (28.3%) at the middle school level, (c) 186 (27.0%) at the high school level, 47 (6.8%) in K – 12th grade settings, 23 (3.3%) in 6th – 12th grade settings, 18 (2.6%) in K – 8th grade settings, and 2 (0.3%) in some other grade level setting. Respondents' ($N = 686$) school type was 94.3% ($n = 651$) Regular Setting, 1.4% ($n = 10$) Alternative Education, 1.0% ($n = 7$) Special Education, and 0.9% ($n = 6$) Career Center, with 1.7% ($n = 12$) being another form of school type. Participants' ($N = 687$) school agency was 91.4% ($n = 631$) public, 7.1% ($n = 49$) private, and 1.0% ($n = 7$) charter, with 3 (0.4%) *not* reporting their school agency type. Regarding Title I status of the participants' school ($N = 686$), 447 (64.8%) reported their school qualifies for Title I, 200 (29.0%) reported their school does *not* qualify for Title I, and 39 (5.7%) do *not* know if their school qualifies for Title I, with 4 (0.5%) *not* responding. Respondents' ($N = 686$) school geographical environment was 36.9% ($n = 253$) suburban, 33.3% ($n = 228$) rural, and 29.8% ($n = 204$) urban with 4 (.5%) *not* reporting their school's geographical environment.

To explore school counseling program implementation, the following section reports: (a) the number of respondents who implement specified school counseling programs and (b) the number of respondents who implement integrated forms of school counseling programs. Respondents had the option to select the multiple school counseling programs (e.g., select *all* that apply) they implemented. The identified school counseling program implementation for the respondents included: (a) 58.8% ($n = 401$) Comprehensive Guidance and Counseling Program, (b) 56.3% ($n = 384$) ASCA National Model, (c) 51.8% ($n = 353$) ASCA National Standards, (d) 37.5% ($n = 256$) State Level Standards or Program, (e) 29.9% ($n = 170$) Developmental Guidance Program, (f) 14.4% ($n = 98$) No Specified Approach or Program, (g) 5.3% ($n = 36$)

some other program, and (h) 0.1% ($n = 7$) Education Trust's Transforming School Counseling Initiative. Regarding participants' ($N = 682$) integration of multiple school counseling program approaches, 477 (69.9%) respondents use *two or more* approaches. Furthermore, 148 (21.4%) of the school counselors who use the integration of two approaches, 162 (23.5%) who use the integration of three approaches, and 165 (23.9%) who use the integration of four or more approaches.

Table 6 *Categorical Demographic Variables – School Characteristics*

Data Category	Total (<i>n</i>)	Percentage
School Level (<i>N</i> = 686)		
Elementary	215	31.2%
Middle	195	28.3%
High School	186	27.0%
K – 8 th Grade	18	2.6%
6 th – 12 th Grade	23	3.3%
K – 12 th Grade	47	6.8%
Other	2	0.3%
School Type (<i>N</i> = 686)		
Regular	651	94.3%
Alternative Education	10	1.4%
Special Education	7	1.0%
Career Center	6	0.9%
Other	12	1.7%
School Agency (<i>N</i> = 687)		
Public	631	91.4%
Private	49	7.1%
Charter	7	1.0%
Does School hold Title I Status? (<i>N</i> = 686)		
Yes	447	64.8%
No	200	29.0%
I don't know	39	5.7%
School Location (<i>N</i> = 685)		
Rural	228	33.3%
Suburban	253	36.9%
Urban	204	29.8%
PSC Program Approach (<i>N</i> = 682) (<i>all that apply</i>)		
ASCA National Model	384	56.3%
ASCA National Standards	353	51.8%
Comprehensive Guidance and Counseling Program	401	58.8%
Developmental Guidance Program	170	29.9%
Education Trust's Transforming School Counseling Initiative	7	0.1%
No Specified Approach or Program	98	14.4%
State Level Standards or Program	256	37.5%
Other	36	5.3%
Use an integration of approaches (<i>2 or more</i>)	477	69.9%
Integrate 2 approaches	148	21.4%
Integrate 3 approaches	162	23.5%
Integrate 4 or more approaches	165	23.9%

Likert Demographic Items

The Likert demographic items sought to examine key factors that influence the work of school counselors past upon prior research (e.g., Butler & Constatine, 2005; Clemens, Milsom, & Cashwell, 2009; Falls & Nichter, 2007). Specifically, these Likert scale items measured (a) principal-counselor relationship, (b) work stress, (c) work satisfaction, and (d) perceived job control. Each construct is measured through the use of a researcher-developed scale that underwent scale development procedures (e.g., DeVellis, 2012) and consists of three items per construct. All items followed a point-value system ranging one (Strongly Disagree) to five (Strongly Agree). The following present the constructs of interest and the Likert scale items used to measure the constructs.

The first Likert statement that participants were asked to respond to regarding their principal counselor relationship was, “*My current principal respects my opinion on important school related issues.*” The data identified an average of 4.16 ($SD = 1.00$; Range = 1 to 5; $Mdn = 4$; Mode = 5), with the frequencies provides in table 7.

Table 7 Likert Demographic Item 1 – Principal-Counselor Relationship

<i>My current principal respects my opinion on important school related issues.</i>	Total (n)	Percentage
Strongly disagree	19	2.8%
Disagree	36	5.2%
Neither disagree or agree	74	10.7%
Agree	236	34.2%
Strongly Agree	314	45.5%

The second Likert statement that participants were asked to respond to regarding their principal counselor relationship was, “*All in all, I enjoy working as a school counselor with my current principal.*” The data identified an average of 4.16 ($SD = 1.00$; Range = 1 to 5; $Mdn = 4$; Mode = 5), with the frequencies provides in table 8.

Table 8 Likert Demographic Item 2 – Principal-Counselor Relationship, Frequency

<i>All in all, I enjoy working as a school counselor with my current principal.</i>	Total (n)	Percentage
Strongly disagree	15	2.0%
Disagree	48	6.5%
Neither disagree or agree	78	10.6%
Agree	212	44.8%
Strongly Agree	329	44.8%

The third Likert statement that participants were asked to respond to regarding their principal counselor relationship was, “*My current principal recognizes the importance of my work as a school counselor.*” The data identified an average of 4.19 ($SD = 1.00$; Range = 1 to 5; $Mdn = 4$; Mode = 5), with the frequencies provides in table 9.

Table 9 Likert Demographic Item 3 – Principal-Counselor Relationship, Frequency

<i>My current principal recognizes the importance of my work as a school counselor.</i>	Total (n)	Percentage
Strongly disagree	19	2.6%
Disagree	42	5.7%
Neither disagree or agree	69	9.4%
Agree	225	30.6%
Strongly Agree	334	45.4%

The first Likert statement that participants were asked to respond to regarding their work satisfaction was, “*I enjoy my work as a school counselor.*” The data identified an average of 4.51 ($SD = 0.70$; Range = 1 to 5; $Mdn = 5$; Mode = 5), with the frequencies provides in table 10.

Table 10 Likert Demographic Item 4 – Work Satisfaction, Frequency

<i>I enjoy my work as a school counselor.</i>	Total (n)	Percentage
Strongly disagree	4	0.5%
Disagree	10	1.4%
Neither disagree or agree	32	4.4%
Agree	227	30.9%
Strongly Agree	416	93.7%

The second Likert statement that participants were asked to respond to regarding their work satisfaction was, “*My work as a school counselor continues to challenge me.*” The data

identified an average of 4.52 ($SD = 0.72$; Range = 1 to 5; $Mdn = 5$; Mode = 5), with the frequencies provides in table 11.

Table 11 *Likert Demographic Item 5 – Work Satisfaction, Frequency*

<i>My work as a school counselor continues to challenge me.</i>	Total (n)	Percentage
Strongly disagree	3	0.4%
Disagree	15	2.0%
Neither disagree or agree	28	3.8%
Agree	217	29.5%
Strongly Agree	426	58.0%

The third Likert statement that participants were asked to respond to regarding their work satisfaction was, “*If I could go back in time, I would choose the same career as a school counselor.*” The data identified an average of 4.08 ($SD = 1.07$; Range = 1 to 5; $Mdn = 4$; Mode = 5), with the frequencies provides in table 12.

Table 12 *Likert Demographic Item 6 – Work Satisfaction, Frequency*

<i>If I could go back in time, I would choose the same career as a school counselor.</i>	Total (n)	Percentage
Strongly disagree	23	3.1%
Disagree	45	6.1%
Neither disagree or agree	101	13.7%
Agree	207	28.2%
Strongly Agree	313	42.6%

The first Likert statement that participants were asked to respond to regarding their work stress was, “*I feel stressed while working as a school counselor.*” The data identified an average of 3.40 ($SD = 1.08$; Range = 1 to 5; $Mdn = 4$; Mode = 4), with the frequencies provides in table 13.

Table 13 Likert Demographic Item 7 – Work Stress, Frequency

<i>I feel stressed while working as a school counselor.</i>	Total (n)	Percentage
Strongly disagree	34	4.6%
Disagree	125	17.0%
Neither disagree or agree	158	21.5%
Agree	275	37.4%
Strongly Agree	97	13.2%

The second Likert statement that participants were asked to respond to regarding their work stress was, “*I think about my work as a school counselor while I am at home.*” The data identified an average of 3.76 ($SD = .99$; Range = 1 to 5; $Mdn = 4$; Mode = 4), with the frequencies provided in table 14.

Table 14 Likert Demographic Item 8 – Work Stress, Frequency

<i>I think about my work as a school counselor while I am at home.</i>	Total (n)	Percentage
Strongly disagree	18	2.4%
Disagree	84	11.4%
Neither disagree or agree	127	17.3%
Agree	337	45.9%
Strongly Agree	123	16.7%

The third Likert statement that participants were asked to respond to regarding their work stress was, “*I lose sleep as the result of my work as a school counselor.*” The data identified an average of 2.37 ($SD = 1.14$; Range = 1 to 5; $Mdn = 2$), with the frequencies provided in table 15.

Table 15 Likert Demographic Item 9 – Work Stress, Frequency

<i>I lose sleep as the result of my work as a school counselor.</i>	Total (n)	Percentage
Strongly disagree	164	22.3%
Disagree	278	37.8%
Neither disagree or agree	109	14.8%
Agree	104	45.9%
Strongly Agree	34	4.6%

The first Likert statement that participants were asked to respond to regarding their perceived job control was, “*I decide on what I do at work on a daily basis as a school*

counselor.” The data identified an average of 3.69 ($SD = 0.98$; Range = 1 to 5; $Mdn = 4$; Mode = 4), with the frequencies provides in table 16.

Table 16 *Likert Demographic Item 10 – Perceived Job Control, Frequency*

<i>I decide on what I do at work on a daily basis as a school counselor.</i>	Total (n)	Percentage
Strongly disagree	19	2.6%
Disagree	73	9.9%
Neither disagree or agree	138	18.8%
Agree	329	44.8%
Strongly Agree	130	17.7%

The second Likert statement that participants were asked to respond to regarding their perceived job control was, “*I have the ability to deliver the services I think are most important for students and families as a school counselor.*” The data identified an average of 3.85 ($SD = 1.05$; Range = 1 to 5; $Mdn = 4$; Mode = 4), with the frequencies provides in table 17.

Table 17 *Likert Demographic Item 11 – Perceived Job Control, Frequency*

<i>I have the ability to deliver the services I think are most important for students and families as a school counselor.</i>	Total (n)	Percentage
Strongly disagree	25	3.4%
Disagree	64	8.7%
Neither disagree or agree	101	13.7%
Agree	302	41.4%
Strongly Agree	197	26.8%

The third Likert statement that participants were asked to respond to regarding their perceived job control was, “*Other people have control over what I do on a daily basis as a school counselor.*” The data was reverse coded and identified an average of 3.11 ($SD = 1.07$; Range = 1 to 5; $Mdn = 3$; Mode = 3), with the frequencies provides in table 18.

Table 18 Likert Demographic Item 12 – Perceived Job Control, Frequency

<i>Other people have control over what I do on a daily basis as a school counselor.</i>	Total (n)	Percentage
Strongly disagree	60	8.2%
Disagree	208	28.3%
Neither disagree or agree	220	29.9%
Agree	151	20.5%
Strongly Agree	50	6.8%
<i>*Reverse coded</i>		

The following section presents the reliability coefficients for the four constructs measured by the Likert scale items with these data. The *Principal-Counselor Relationship scale* (items 1-3) had a Cronbach's α of .927. The *Work Satisfaction scale* (items 4-6) had a Cronbach's α of .755. The *Work Stress scale* (items 7-9) had a Cronbach's α of .741. The *Perceived Job Control scale* (items 10-12) had a Cronbach's α of .615. The entire scale (*all 12 items*) produced had a Cronbach's α of .686. Therefore, *all* the Likert scale items groups and the entire Likert scale have sound internal reliability coefficients ($> .60$; Hair, Black, Babin, Anderson, & Tatham, 2006), with the *Perceived Job Control* and the entire scale (*all 12 items*) having moderate to questionable sound internal reliability coefficients.

Professional Quality of Life

Professional quality of life relates to individuals' psychosocial reactions as a result of their work as a helping professional (Stamm, 2010). To measure the professional quality of life construct, the *Professional Quality of Life scale* (ProQOLs; Stamm, 2010) was administered to participants. The ProQOLs (Stamm, 2010) is a 30-item self-report instrument that measures two compassion factors, which include compassion satisfaction and compassion fatigue. Compassion fatigue is broken into two subscales, which include burnout and secondary traumatic stress. Overall, the ProQOLs consists of three subscales, including: (a) compassion satisfaction (10

items), (b) burnout (10 items), and (c) secondary traumatic stress (10 items). Burnout and secondary traumatic stress combine to represent compassion fatigue. The ProQOLs items consist of statements that represent the constructs being measured (e.g., burnout, secondary traumatic stress, and compassion satisfaction) in which the respondent reads and selects a frequency value. The options for frequency value range (1-5) from (a) Never, (b) Rarely, (c) Sometimes, (d) Often, and (e) Very Often. See the appendix for a copy of the ProQOLs used in this study.

The following section examines the Cronbach's α to assess the internal consistency reliability of the ProQOLs. Cronbach's α for the entire ProQOLs scale (*all 30 items*) was .650, which is moderate to questionable with these data (Hair et al., 2006). It is important, yet often forgotten, to report the reliability of interment scales (Osborne, 2013). Regarding the three scales, the Compassion Satisfaction scale of the ProQOLs had a Cronbach's α of .880, the Burnout scale had a Cronbach's α of .783, and the Scondary Tramatic Stress scale had a Cronbach's α of .766. All of the ProQOLs scales are within appropriate α levels (Hair et al., 2006). These results provide evidence that the ProQOLs is more reliable as a measure of the three ProQOLs subscales than as an entire instrument (total score), as indicated by the values of the reliability alphas. The measures of central tendency for the ProQOLs are presented in table 19.

Table 19 *ProQOLs Central Tendencies*

Scale (N = 690)	Mean (M)	SD	Range	Mdn	Mode
Burnout	20.83	5.29	10 to 40 (30)	20	20
Secondary Traumatic Stress	19.40	4.92	10 to 40 (30)	19	17
Compassion Satisfaction	42.50	5.47	20 to 50 (30)	43	43
<i>Total Score</i>	78.26	7.62	57 to 110 (53)	77	77

School Counselor Self-Efficacy

Self-efficacy represents the confidence an individual holds in regards to specified tasks or behaviors (Bandura, 1999). The *School Counselor Self-Efficacy Scale* (SCSEs; Bodenhorn & Skaggs, 2005) is a self-report instrument that consists of 43-items that intends to measure school counselors' self-efficacy. The SCSEs includes five subscales that target specific school counselor job roles, including: (a) Personal and Social Development (12 items), (b) Leadership and Assessment (nine items), (c) Career and Academic Development (seven items), (d) Collaboration (11 items), and (e) Cultural Awareness (four items). The SCSEs is comprised of role specific statements inquiring about the confidence with which the respondent can completed that task identified in the statement. The participants indicate their response on a five-point Likert scale (values 1-5) ranging from (a) Not Confident, (b) Slightly Confident, (c) Moderately Confident, (d) Generally Confident, and (e) Highly Confident. See the appendix for a copy of the SCSE used in this study.

The following section presents the Cronbach's alphas to assess the internal consistency reliability of the SCSEs. Cronbach's α for the entire SCSEs scale (*all 43 items*) was .959, identifying high internal consistency reliability (Hair et al., 2006). Regarding the five SCSEs subscales, the *Personal and Social Development* scale had a Cronbach's α of .887, the *Leadership and Assessment* scale had a Cronbach's α of .900, the *Career and Academic Development* scale had a Cronbach's α of .864, the *Collaboration* scale has a Cronbah's α of .846, and *Cultural Awareness* scale had a Cronbach's α of .669. All of the SCSEs scales had an acceptable internal reliability coefficient (Hair et al., 2006). The measures of central tendency for the SCSEs are presented in table 20.

Table 20 SCSE Central Tendencies

Scale (<i>N</i> = 690)	Mean (<i>M</i>)	<i>SD</i>	Range	<i>Mdn</i>	Mode
Personal and Social Development	51.31	6.28	12 to 60 (48)	52	49
Leadership and Assessment	33.90	6.58	11 to 45 (34)	34	33
Career and Academic Development	28.08	4.66	8 to 35 (27)	28	28
Collaboration	47.45	5.72	11 to 55 (44)	48	55
Cultural Awareness	16.89	2.32	4 to 20 (14)	17	16
<i>Total Score</i>	177.64	22.37	46 to 215 (169)	179	171

Programmatic Service Delivery

School counselor programmatic service delivery represents the job related tasks that are completed by school counselors. The *School Counselor Activity Ratings Scale* (SCARS; Scarborough, 2005) is a 48-items self-report measure that uses two scales to examine the frequency of (a) tasks school *prefer* to complete and (b) tasks that are *actually* completed. For this investigation, the scale that measures the tasks that are *actually* completed (*not* the preferred scale). The SCARS has five subscales, including: (a) Counseling Activities (10 items) (b) Consultation Activities (seven items); (c) Coordination Activities (13 items); (d) Curriculum Activities (eight items); and (e) Other Activities (i.e., nonessential tasks; 10 items). The SCARS is comprised of role specific statements inquiring about the frequency with which the respondent completes that task identified in the statement. The participants indicate their response on a five-point Likert scale (values 1-5) ranging from (a) I never do this, (b) I rarely do this, (c) I occasionally do this, (d) I frequently do this, and (e) I routinely do this. See the appendix for a copy of the SCARS used in this study.

The following section presents the Cronbach's alphas to assess the internal consistency reliability of the ProQOLs with these data. Cronbach's α for the entire SCARS scale (*all* 48

items) was .910, which is high (Hair et al., 2006). Regarding the five SCARS subscales, the *Counseling Activities* scale had a Cronbach's α of .851, the *Consultation Activities* scale had a Cronbach's α of .773, the *Coordination* scale had a Cronbach's α of .864, the *Curriculum Activities* scale has a Cronbach's α of .931, and *Other Activities* scale had a Cronbach's α of .644. All of the SCARS scales had an acceptable internal reliability coefficient with these data (Hair et al., 2006) . The measures of central tendency for the SCARS are presented in table 21.

Table 21 SCARS Central Tendencies

Scale (N = 690)	Mean (M)	SD	Range	Mdn	Mode
Consultation Activities	26.25	4.76	9 to 35 (26)	26	27
Counseling Activities	35.37	6.73	10 to 50 (40)	36	38
Curriculum Activities	25.94	8.85	8 to 40 (32)	26	36
Coordination Activities	41.43	9.43	14 to 65 (51)	42	42
Other Activities	30.58	7.16	10 to 50 (40)	30	28
<i>Total Score</i>	159.47	25.64	65 to 240 (175)	161	165

Data Analysis for the Research Hypothesis and Exploratory Research Questions

This investigation examined the contribution of practicing school counselors' self-efficacy and professional quality of life to their programmatic service delivery. The following section presents the resulting data analysis for the primary research questions and hypothesis and the exploratory research questions. The data in this study were managed and analyzed by using the *Statistical Package for the Social Sciences* (SPSS, Version 21) and the *Analysis of Moment Structures* (AMOS, Version 21). The statistics utilized in this study included, (a) SEM, (b) Spearman Rho Correlations, (c) MLR, (d) Kruskal Wallis H test, (e) Mann-Whitney U test, (f) Chi Square test of independence, and (g) Descriptive Statistics. SEM involves a five stand step process, including (a) Model Specification, (b) Model Identification, (c) Model Estimation (d) Model Testing, and (e) Model Modification. Also, the SEM analysis utilized Exploratory Factor

Analysis (EFA) and Confirmatory Factor Analysis (CFA) in identifying and testing the measurement model.

Data Screening and Statistical Assumptions for SEM

In *all* quantitative analysis it is critical to screen the data and check for statistical assumptions (Hair et al., 2006). SEM has several statistical assumptions, which include: (a) adequate sample size, (b) consideration of missing data, (c) examination of outliers, (d) univariate and multivariate normality, (e) multicollinearity and singularity, (f) linearity of variables, and homoscedasticity. The following section reviews the assessment of the statistical assumptions with these data.

In SEM, a minimum sample size of 200 is recommended (Bryne, 2010; Hair et al., 2006); however, Raykov and Marcoulides (2006) suggest that when estimating sample size for SEM, “a cautious and simplified attempt at a rule of thumb might suggest that sample size would be desirably be more than 10 times the number of free model parameters” (p. 30), which suggests a minimum sample of 290 for this investigation. In addition, sample sizes range from 100-400 based on model complexity and measurement model characteristics with larger samples (> 400) model estimation becomes more sensitive making fit indices suggest poor fit (Hair et al., 2006). Most published research employing SEM ranges in sample size from 100-500 (Schumacher & Lomax, 2010). The sample size for this investigation, at 690, met the minimum size required for SEM (and the other data analysis).

Missing data can reduce sample size, impacting data analysis, and results in biased results (Hair et al., 2006). Consideration for missing data is often overlooked but an essential concern in quantitative research (Osborne, 2013). For this review of missing data, the researcher examined the main constructs (e.g., self-efficacy, professional quality of life, and service delivery), *not* the

demographic items. In this study, 735 participants returned packets that were started with 690 (93.9%) of these packets having complete data, resulting in 6.12% ($n = 45$) participants with missing data. To better understanding participants with missing data, the researcher examined the percentage of missing data by case. Within the *missing data group* ($n = 45$), the average number of items missing by *case* (e.g., participant) was 57.95 ($SD = 15.47$; $Mdn = 52$; Range = 15 to 85; Mode = 52) and the average percentage of missing items (number of missing items divided by total items) was 47.9% ($SD = 22.98\%$; $Mdn = 42.98\%$; Range = 12% to 83%; Mode = 43%). A visual inspection of the missing data hints to attrition (e.g., items at the end of the instruments were *not* completed more often the items at the beginning for the instruments). The cases within this group are *not* ignorable because the items in the missing data exceed 10% (e.g., more than 10% of the items were missing). Based upon the consideration that: (a) the group of cases with substantial missing data is small (e.g., 6.12%); (b) often times, the dependent/endogenous variable was missing; and (c) the missing data is non-randomly missing, a decision to delete these cases was made (Hair et al., 2006).

Hair and colleagues (2006) suggest researchers consider the extent to which data is missing from the *variables being studied*. The average number of data points missing by *variable* (e.g., instrument item) was 21.55 ($SD = 9.13$, $Mdn = 22$, Range = 8 to 37, Mode = 14) and the average percentage of missing cases (number of missing cases divided by total cases [735]) was 2.93% ($SD = 1.24\%$, $Mdn = 2.99\%$, Range = 1% to 5%, Mode = 2%). Based upon these findings, *no* variables were removed due to missing items since the missing data is ignorable because it is under 10 percent (Hair et al., 2006), resulting with a usable sample of 690.

Outliers consist of observations that are significantly different from other observations in the dataset (Hair et al., 2006); thus, necessitating attention in quantitative research. To examine

univariate outliers the data was converted to standardized scores and the cases where the z-score was greater than +4 or less than -4 (e.g., four standard deviations from the mean) were removed (Hair et al., 2006), resulting in the removal of 83 cases. Next, the researcher examined bivariate outliers by examining the scatterplots of the independent/exogenous variables and the dependent/endogenous variable, resulting in the removal of 28 cases. Finally, the researcher examined the multivariate outliers by reviewing Mahalanobis distance and Cook's distance for *all* items used in the SEM, resulting in two items removed. After exploring and removing outliers the usable sample size was 577, for which was appropriate for SEM.

Normality is an important assumption in multivariate statistics and if the data are significantly non-normal, the results may *not* be valid (Hair et al., 2006). To review normality, the researcher first examined univariate normality using the visual inspection of normality plots, reports of skewness and kurtosis statistics, and the Shapiro-Wilks test of significance for normality. The visual inspection of items on the normality plots indicated non-normality due to the lack of fit to normal curve overlay on the histogram. Next, an inspection of the skewness and kurtosis showed significant non-normality (as indicated by a z_{kurtosis} greater than ± 2.58 ; Hair et al., 2006) on multiple items (27 items on the ProQOLs, 43 [*all*] items on the SCSE, and 33 items on the SCARS). Then, the researcher examined the Shapiro-Wilks test of significance, which confirmed that the data collected from the ProQOLs, SCSEs, and SCARS had significant non-normality. For a dataset to have bivariate and multivariate normality it must have univariate normality (Hair et al., 2006); therefore, it is assumed that the dataset does *not* have a normal distribution at the bivariate or multivariate level. Notable, the researcher attempted several forms of data transformation (log, power, and Box-Cox; Osborn, 2013) but found inconclusive results. The researcher noted the impact of the non-normal distribution on the interpretation of the

results. Furthermore, the researcher used statistical techniques to address non-normal data when available.

Multicolinearity occurs when independent variables have high levels of correlations ($r = .9$ or higher) between each other (Hair et al., 2006) and is a concern for MLR and SEM. To check multicollinearity of the main constructs the researcher used a MLR analysis by placing the independent/exogenous variables (factors from SCSEs [Bodenhorn & Skaggs, 2005] and ProQOLs [Stamm, 2010]) as predictors of the dependent/endogenous variable (SCARS; Scarborough, 2005) to assess for Tolerance and the Variance Inflation Factor (VIF). It is suggested that Tolerance should remain above .10 and the VIF should be below 10, which indicates there is *no* multicollinearity. The Tolerance values averaged .46 ($SD = .14$, $Mdn = .42$, Range = .31 to .73) and the VIF values averaged 2.35 ($SD = .62$, $Mdn = 2.40$, Range = 1.38 to 3.23), which provides evidence that *no* multicollinearity was present with these data. To further analyze multicollinearity, the researcher examined the correlations between the independent/endogenous factors with any correlations over $r = .9$ resulting is multicollinearity (Hair et al., 2006). A review of the correlations between the independent/endogenous factors did *not* find any correlations of $r = .9$ or higher with these date. As such, there was *no* multicollinearity present in the independent/endogenous factors. Importantly, the researcher independently assessed multicollinearity for regression analysis conducted with the exploratory research questions.

Linearity refers to the pattern of associations between variables and the ability to have the correlation coefficient account for the relationship. To assess the linearity of variables, the researcher visually inspected the scatterplots of the variables with the goal of identifying patterns of nonlinear relationships. A review of the scatterplots for the variables (items from the SCSEs

[Bodenhorn & Skaggs, 2005] and ProQOLs [Stamm, 2010]) returned *no* concern for nonlinear relationships. Therefore, the assumption of linearity was satisfied with these data.

Homoscedasticity is a commonly violated assumption in MLR that represents the need for equal variances (Hair et al., 2006). To examine homoscedasticity, the researcher produced scatterplots of the standardized residuals of the independent variables against the dependent value with the goal of identifying whether the pattern was consistent (homoscedasticity) or erratic (heteroscedasticity). All of the scatterplots of the standardized residuals for the independent variables were constant and formed. Therefore, homoscedasticity was assumed with these data.

Adjusted Descriptive Statistics for Data Analysis

In the data screening process, extreme outliers ($n = 113$) were removed from the sample for the data analysis. The resulting sample size was 577. To gain a better understanding of the data used for the data analysis the measures of central tendencies of the screened data for professional quality of life, self-efficacy, and programmatic service delivery are present in 22-24.

Table 22 *Adjusted ProQOLs Central Tendencies*

Scale ($N = 577$)	Mean (M)	SD	Range	Mdn	Mode
Burnout	20.22	4.87	10 to 36 (30)	20	20
Secondary Traumatic Stress	18.75	4.10	10 to 32 (30)	18	17
Compassion Satisfaction	43.16	4.48	27 to 50 (30)	44	43
<i>Total Score</i>	77.60	6.67	57 to 97 (53)	77	77

The following section examines the Cronbach's α to assess the internal consistency reliability of the ProQOLs with these screened data. Cronbach's α for the entire ProQOLs scale (*all 30 items*) was .650, which is moderate to questionable with these data (Hair et al., 2006).

Regarding the three scales, the Compassion Satisfaction scale of the ProQOLs had a Cronbach's α of .880, the Burnout scale had a Cronbach's α of .783, and the Secondary Traumatic Stress scale had a Cronbach's α of .766. All of the ProQOLs scales are within appropriate α levels (Hair et al., 2006). These results provide evidence that the ProQOLs is more reliable as a measure of the three ProQOLs subscales than as an entire instrument (total score), as indicated by the values of the reliability alphas.

Table 23 *Adjusted SCSE Central Tendencies*

Scale (N = 577)	Mean (M)	SD	Range	Mdn	Mode
Personal and Social Development	52.15	5.42	37 to 60 (48)	52	49
Leadership and Assessment	34.52	6.13	14 to 45 (34)	34	33
Career and Academic Development	28.77	4.02	16 to 35 (27)	29	28
Collaboration	48.22	4.85	34 to 55 (44)	49	55
Cultural Awareness	17.09	2.09	11 to 20 (14)	17	17
<i>Total Score</i>	180.75	19.46	126 to 215 (169)	179	171

The following section presents the Cronbach's alphas to assess the internal consistency reliability of the SCSEs with these screened data. Cronbach's α for the entire SCSEs scale (all 43 items) was .959, identifying high internal consistency reliability (Hair et al., 2006). Regarding the five SCSEs subscales, the *Personal and Social Development* scale had a Cronbach's α of .887, the *Leadership and Assessment* scale had a Cronbach's α of .900, the *Career and Academic Development* scale had a Cronbach's α of .864, the *Collaboration* scale has a Cronbach's α of .846, and *Cultural Awareness* scale had a Cronbach's α of .669. All of the SCSEs scales had an acceptable internal reliability coefficient (Hair et al., 2006).

Table 24 *Adjusted SCARS Central Tendencies*

Scale (<i>N</i> = 577)	Mean (<i>M</i>)	SD	Range	<i>Mdn</i>	Mode
Counseling Activities	26.29	4.60	9 to 35 (26)	26	28
Consultation Activities	35.70	6.36	14 to 50 (36)	36	37
Curriculum Activities	26.66	8.62	8 to 40 (32)	27	36
Coordination Activities	42.07	9.05	14 to 65 (51)	42	41
Other Activities	30.49	7.12	10 to 50 (40)	30	28
<i>Total Score</i>	161.22	24.53	65 to 240 (175)	163	171

The following section presents the Cronbach's alphas to assess the internal consistency reliability of the SCARS with these screened data. The Cronbach's α for the entire SCARS scale (*all* 48 items) was .910, which is high (Hair et al., 2006). Regarding the five SCARS subscales, the *Counseling Activities* scale had a Cronbach's α of .851, the *Consultation Activities* scale had a Cronbach's α of .773, the *Coordination* scale had a Cronbach's α of .864, the *Curriculum Activities* scale has a Cronbach's α of .931, and *Other Activities* scale had a Cronbach's α of .644. All of the SCARS scales had an acceptable internal reliability coefficient with these data (Hair et al., 2006). The measures of central tendency for the SCARS are presented in table 24.

Estimation Technique

Non-normal data and its violation of estimation assumptions should *not* be ignored (Curran, West, & Finch, 1997; Olsson, Foss, Troye, & Howell, 2000). Maximum Likelihood (ML) is a commonly used method for estimation but it is volatile towards non-normal data (Bryne, 2010; Kline, 2011; Schumacher & Lomax, 2010). Weighted Least Squares (WLS; known as *asymptotically distribution-free* in AMOS) is an approach to estimation that “estimates the degree of both skew and kurtosis in the raw data”, which means there are *no* assumptions made regarding the distribution of the data (Kline, 2011, p. 178). However, the use of WLS requires large sample size for simple (200-500) and complex models (> 500; Kline, 2011). WLS is more stringent regarding goodness of fit and model specification. Therefore, the researcher

utilized the WLS estimation technique to examine the fit of the measurement models because of their simplicity and the overall sample size ($N = 577$).

The complexity of the structural model for this investigation prevented the use of WLS because the sample size was *not* large enough, which is a common issue related to the use of WLS (Kline, 2011; Raykov & Marcoulides, 2006). Alternative methods to handle non-normal data include Bootstrapping (Bryne, 2010), Bayesian Estimation (Bryne, 2010), Raw Data Transformation (Osborne, 2013; Raykov & Marcoulides, 2006), and Satorra-Bentler Robust ML approach (Raykov & Marcoulides, 2006; Schumacher & Lomax, 2010). All of the aforementioned methods to handle non-normal data were considered; however, none produced fruitful results. Furthermore, the Satorra-Bentler Robust ML approach is only available on some of the available SEM software programs (e.g., Mplus, R, and EQS; Raykov & Marcoulides, 2006; Schumacher & Lomax, 2010), of which the researcher did *not* have access or familiarity.

Parceling of Ordinal Data

The type of data (continuous versus ordered-categorical) impacts the estimation technique (Bovaird & Koziol, 2012). Ignoring ordinal data (e.g., treating it like continuous data) can lead to bias (e.g., minimization of fit) in the results of an SEM model (Raykov & Marcoulides, 2006). Specifically, ordinal data (e.g., Likert based interments) is unlikely to be normally distributed as a result of too few agreement options (Kline, 2011). The data resulting from the use of *five or more* selection items on an ordinal scale *may* be considered continuous (Raykov & Marcoulides, 2006); however, normality may still be a challenge to achieve (Kline, 2011). Parceling increases the likelihood of meeting normality assumptions and gives more support to treat the data as continuous (Bovaird & Koziol, 2012).

Parceling is the process in which similar items are summed or averaged to form a composite item (Bovaird & Koziol, 2012; Kline, 2011). Parceling of indicators into composite scores is a method to handle non-normal data (Kline, 2011). Therefore, the data was parceled to achieve the best representation of the hypothesized model despite the data being both ordinal and non-normal. However, literature exists that denotes parceling as a bad practice (Little, Cunningham, Shahar, & Widaman, 2002); thus, the researcher examined an alternative and equivalent model that does *not* parcel but used second-order measurement models instead. Both the parceled and second-order models are compared to identify which model best represents the data.

Research Hypothesis and Exploratory Questions

This study investigated the contribution of school counselors' self-efficacy and professional quality of life to their programmatic service delivery. In addition, this study examined the relationships between demographic factors to school counselors' self-efficacy, professional quality of life, and programmatic service delivery. Furthermore, this study examined the impact of survey methodology on participants' response rate and response characteristics. The section that follows presents the data analysis of the research hypothesis and exploratory research questions. To examine the primary research question this study utilized SEM. SEM involved five steps, including: (a) specification, (b) identification, (c) estimation, (d) evaluation, and (e) modification. To determine goodness of fit, the researcher used suggested (Fan & Sivo, 2005; Hu & Bentler, 1999; MacCallum et al., 1996) fit indices (table 25 lists and described the fit indices used).

Table 25 Description of Fit Indices

Fit Indices	Description	Cutoff Criteria
Chi-Square (χ^2)	Examines the comparison of the observed covariance matrix and predicted covariance matrix with the goal of verifying that the model predicts the matrix.	If the χ^2 is <i>not</i> significant, the model is acceptable.
Comparative Fit Index (CFI)	Examines the comparison of the ratio between the discrepancy of the hypothesized model to the discrepancy of the alternate model. The alternate model being derived from making latent variables and indicators uncorrelated. Least sensitive to sample size.	Greater or equal to .95
Root Mean Squared Error of Approximation (RMSEA)	Examines the amount of variance within the hypothesized model. Good fit index for models with few parameters and is sensitive to <i>df</i> .	Less than or equal to .08
Goodness of fit Index (GFI)	Examines the actual variance and covariance. Used as an alternative to chi-square.	Greater than or equal to .90
Standardized Root Mean Squared Residual (SRMR)	Examines the standardized difference between the observed and predicted correlation and is an absolute measure of fit.	Less than or equal to .06

Chart adopted from Fan & Sivo, 2005; Hu & Bentler, 1999; MacCallum et al., 1996

Primary Research Question

Do practicing school counselors' levels of professional quality of life (as measured by the ProQOLs [Stamm, 2010]) and their self-efficacy (as measured by the SCSEs [Bodenhorn & Skaggs, 2005]) contribute to their levels of service delivery (as measured by the SCARS [Scarborough, 2005])?

Research Hypothesis

School counselors' professional quality of life (as measured by the ProQOLs [Stamm, 2010]) and their self-efficacy (as measured by the SCSEs [Bodenhorn & Skaggs, 2005]) contributed to their service delivery (as measured by the SCARS [Scarborough, 2005]). Please see figure 10. Specifically, this investigation tested the hypothesized directional relationship that practicing school counselors scoring at higher levels of professional quality of life and higher levels of self-efficacy would have higher levels of service delivery.

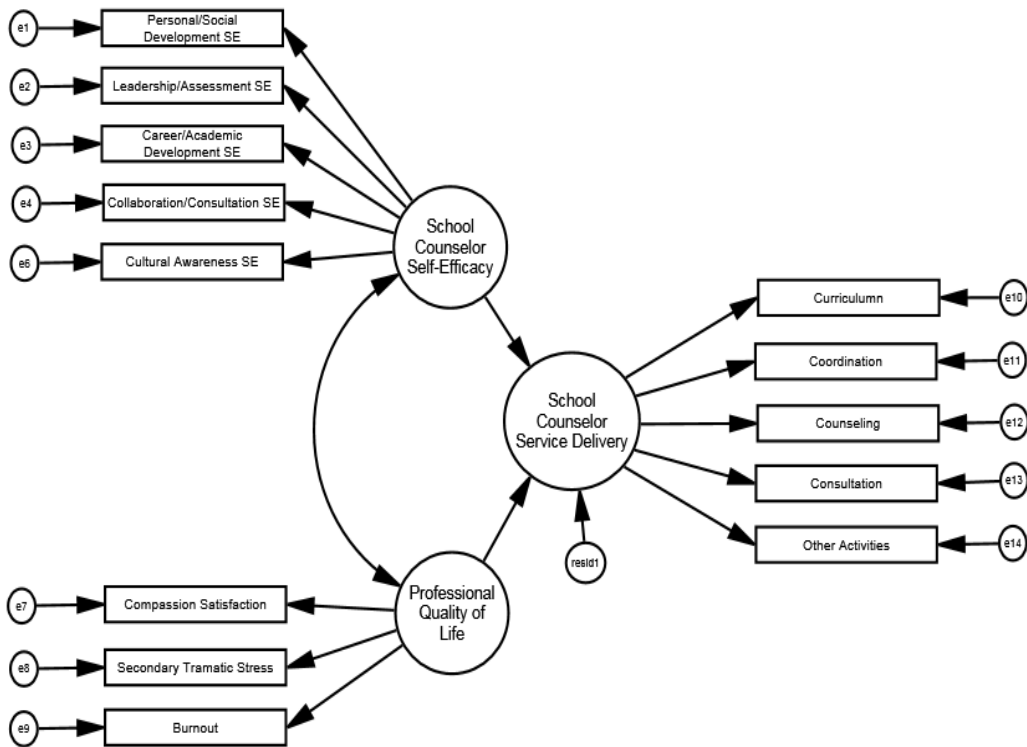

Figure 10: Path Diagram of the Structural Model to be tested

Model Specification and Identification

The first step in SEM is the specification of the model, which is conducted prior to data collection. The specification procedures are based upon literature and should result in a

theoretically sound model set for testing (Schumacher & Lomax, 2010). The hypothesized model in this study was formed prior to data collection and is based upon a thorough review of the literature on the topics. For this model to be specified, the hypothesized model must be consistent with the true population (e.g., representative sample). Model identification involves the checking as to whether or *not* the model can produce a unique solution. O'Brien (1994) states that a measurement model is likely to be identified when:

- (a) there are two or more latent variables, each with at least three indicators that load on it, the errors of these indicators are *not* correlated, and each indicator loads on only one factor, or (b) there are two or more latent variables, but there is a latent variable on which only two indicators load, the errors of the indicators are *not* correlated, each indicator loads on only one factor, and the variances or covariances between factors is zero. (Crockett, 2010, pg. 36)

Therefore, prior to examining the hypothesized model, the measurement models for each latent variable were specified and identified using an EFA and CFA.

Measurement Model Modification for this Data

In the initial review of the measurement model, it was clear that the theorized models based upon previous research and scale development did *not* fit these data. Over half the items in each instrument did *not* fit the model. Therefore, the researcher consulted with two experts in SEM analysis (e.g., Dr. Steve Sivo at the University of Central Florida and Dr. Rex Kline at Concordia University) and their suggestions agreed with the method the researcher took to adjust the measurement models. First, the researcher examined the data through EFA. Then, the researcher used CFA to confirm the EFA findings and test model fit. In addition, the researcher confirmed that the questions used in the modified structures represented the theorized structure

by reviewing the final items selected for each theorized latent factor. Through this two step factor analysis process, the researcher identified the indicators and latent factors that were represented with these data.

CFA models often necessitate respecification and the reasons for respecification include: (a) improve model fit, (b) large standardized residual in the covariance matrix, and (c) poor parameter estimates (Brown & Moore, 2012). In addition, respecification is used to enhance parsimony, simplify complex models, and assure the model is theoretically meaningful (Brown & Moore, 2012; Bryne 2010; Raykov & Marcoulides, 2006; Schumacher & Lomax, 2012). If the collected data does *not* fit the theorized model, researchers should make adjustments to assure the latent factors are meaningful and representative of the constructs being investigated (Brown & Moore, 2012; Raykov & Marcoulides, 2006). The following section reviews the data analysis processes followed to develop the measurement models.

Factor Analysis for Professional Quality of Life

School counselors' professional quality of life was measured using the ProQOLs (Stamm, 2010). Upon initial review of the data using CFA, many of the indicators (e.g., items) did *not* fit the theorized structure due to high standardized residual covariance, low factor loadings, or poor goodness of fit (Schumacher & Lomax, 2010). Therefore, to identify the factors of the desired constructs (e.g., Burnout, Compassion Satisfaction, and Secondary Traumatic Stress) an EFA was conducted. The EFA of the 30-item ProQOLs employed the extraction procedure of principal axis factoring (due to non-normality) with Promax rotation (Costello & Osborne, 2005; Fabrigar et al., 1999; Hair et al., 2006). First, the researcher eliminated items based upon: (a) low factor loadings ($< .30$), (b) low commonality ($< .5$), and (c) cross-loading on more than one factor (Hair et al., 2006), resulting in the elimination of 21 items. Next, the researcher re-loaded

each ProQOLs item to assess for the strongest model, resulting in the addition of another item (total of 10 items).

The criterion used to determine the number of factors the ProQOLs was based upon the number of factors with an eigenvalue one or higher (e.g., Kaisers rule; Mertler & Vannatta, 2005). Additionally, the Scree Plot was consulted to verify the factor solution (see figure 11; Hair et al., 2006). A three-factor solution was derived (see table 26). Bartlett's test of Sphericity produced a statistically significant value ($\chi^2 = 1753.10$, $df = 45$, $p < .001$), which indicates that the data were correlated. The analysis produced a Kaiser-Meyer-Olkin (KMO) measure of sampling adequacy index of .78, which is considered commendable (Dimitrov, 2012; Hair et al., 2006). The three factors account for 66.44% of total variance, which is satisfactory in social science research (Hair et al., 2006). The commonalities were acceptable with four of them below .5 (see table 26; Hair et al., 2006). Factor one represents Burnout, factor two represents Compassion Satisfaction, and factor three represents Secondary Traumatic Stress. A review of the ProQOLs items (e.g., question content) and theoretical groundwork (e.g., Stamm, 2010) supported the assignment of factor labels.

The following section presents the Cronbach's alphas to assess the internal consistency reliability of the modified ProQOLs with these data. Cronbach's α for the entire modified ProQOLs scale (*all 10 items*) was .547, which is low (Hair et al., 2006). Regarding the three ProQOLs subscales, the *Burnout* scale had a Cronbach's α of .798, the *Compassion Satisfaction* scale had a Cronbach's α of .791, and *Secondary Traumatic Stress* scale had a Cronbach's α of .791. The three ProQOLs subscales had an acceptable internal reliability coefficient with these data; however, the ProQOLs total scale had low internal reliability with these data (Hair et al.,

2006). Therefore, these findings indicate the ProQOLs has more internal reliability when subscales were used rather than the total scale with these data

Table 26 *Exploratory Factor Analysis of the ProQOLs*

Item	Factor			Comm.
	1	2	3	
ProQol_22	0.751	0.045	-0.042	.560
ProQol_24	0.749	0.024	0.000	.552
ProQol_27	0.707	-0.026	0.084	.491*
ProQol_20	0.636	-0.066	-0.021	.442*
ProQol_21	0.042	0.873	-0.039	.719
ProQol_26	-0.045	0.715	0.029	.549
ProQol_19	-0.021	0.650	0.035	.450*
ProQol_14	0.008	-0.075	0.768	.549
ProQol_13	-0.079	0.034	0.709	.555
ProQol_9	0.091	0.076	0.609	.391*
Eigenvalue	3.30	1.94	1.41	
Variance (%)	32.99	19.37	14.07	

* Denotes low commonalities

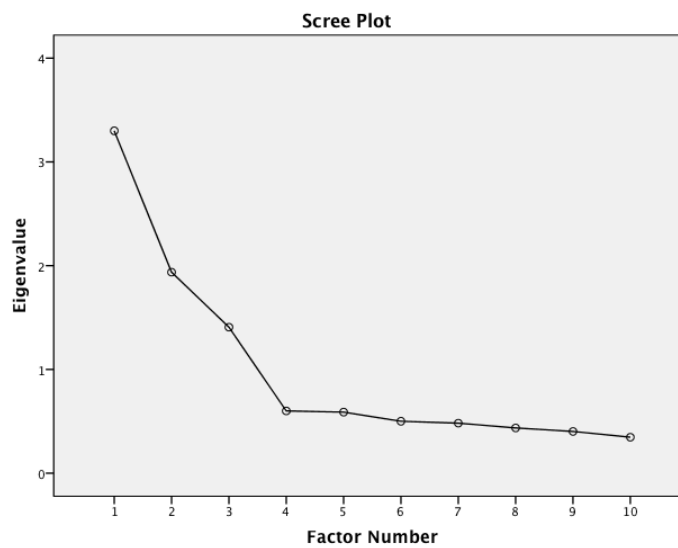

Figure 11: Scree Plot for the ProQOLs

To further examine the factors found in the EFA of the ProQOLs with the data, a CFA was conducted. The CFA for the ProQOLs was specified based on the findings from the EFA, which was congruent with the theoretical structure identified by the author of the ProQOLs (Stamm, 2010). Noteworthy, the ProQOLs has *never* been validated using EFA or CFA with school counselors until this study. Initially, the ProQOLs model was tested but did *not* specify and did *not* meet the cutoff criteria for the specified fit indices with these data (see table 27). Therefore, the ProQOLs model was modified based upon the examination of the EFA. All items on the modified measurement model had significant factor loadings ranging from .62 to .72 (Comrey & Lee, 1992; Stevens, 1992; Tabachnick & Fidell, 2006). The standardized residual covariance matrix produced *no* covariances greater than 2.58 and few greater than 1.96, which supported the strength of the ProQOLs model (Schumacher & Lomax, 2010). Furthermore, the ProQOLs model aligned with O'Brien's (1994) criteria for an identified measurement mode. The respecified model provided a good fit for the ProQOLs with these data (see table 27)

Table 27 *Model fit Indices of the ProQOLs*

	χ^2	<i>df</i>	<i>p</i>	GFI	CFI	RMSEA	SRMR
Theorized Measurement Model	1825.50	402	.000	.793	.756	.078	.086
Respecified Measurement Model (Figure 12)	59.65	32	.002	.974	.951	.039	.036

Note. The original model was estimated using ML because WLS requires fewer parameters per sample size. The respecified model was estimated using WLS.

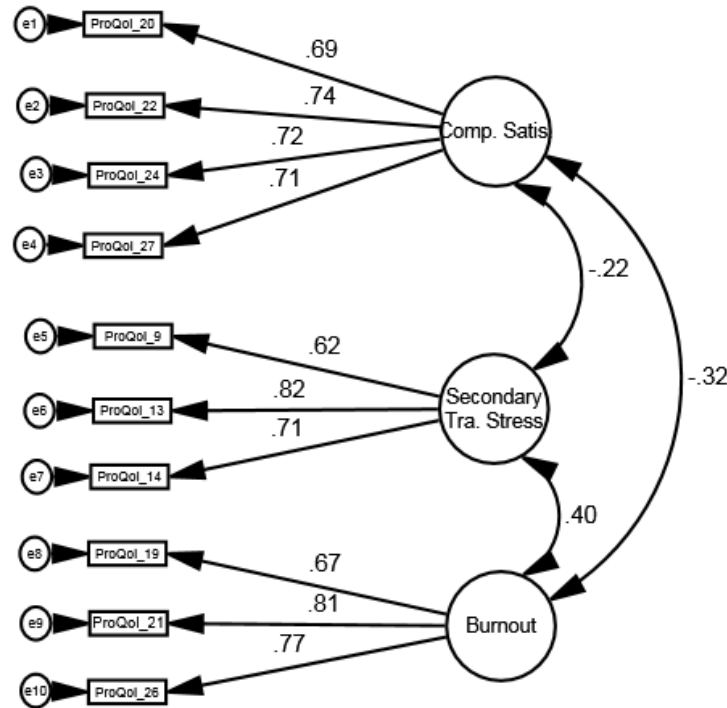

Figure 12: Modified Measurement Model of the ProQOLs

Factor Analysis for School Counselor Self-Efficacy

School counselors' self-efficacy was measured using the SCSEs (Bodenhorn & Skaggs, 2005). The theoretical structure of the SCSEs was constructed based upon previous research that identified a five factor model (e.g., Bodenhorn & Skaggs, 2005). After initial review of the data using CFA, many of the SCSEs items did *not* fit the theorized structure due to high standardized residual covariance, low factor loadings, or poor goodness of fit (Schumacher & Lomax, 2010). Thus, to identify the factors of self-efficacy with these data, EFA was conducted. The EFA of the 43-item SCSEs employed the extraction procedure of principal axis factoring (due to non-normality) with Promax rotation (Costello & Osborne, 2005; Fabrigar et al., 1999; Hair et al., 2006). First, the researcher eliminated SCSEs items based upon: (a) low factor loadings ($< .30$), (b) low commonality ($< .5$), and (c) cross-loading on more than one factor (Hair et al., 2006), resulting in the elimination of 33 items. Next, the researcher re-loaded each SCSEs item to assess for the strongest model, resulting in the addition of two items (total of 12 items).

Traditionally, the criterion to determine the number of factors for the SCSEs would be based upon the number of factors with an eigenvalue one or higher (e.g., Kaisers rule; Mertler & Vannatta, 2005). However, the resulting SCSEs factor model identification was *not* theoretically sound. Therefore, the researcher forced a four-factor SCSEs model, adhering to the theoretical model of the remaining 12 items. The percent variance explained was also examined with a four-factor SCSEs model accounting for 67.67% of total variance, which is satisfactory in social science research (Hair et al., 2006). The Scree Plot was examined and the researcher determined a break that verified a four-factor solution was best (see figure 28; Hair et al., 2006). Bartlett's test of Sphericity produced a statistically significant value ($\chi^2 = 2612.36$, $df = 66$, $p < .001$), indicating that the data were correlated. The analysis produced a KMO measure of sampling adequacy index of .91, which is considered commendable (Dimitrov, 2012; Hair et al., 2006). The commonalities were acceptable with five of them below .5 (see table 28; Hair et al., 2006). SCSEs factor one represents *Leadership and Assessment Self-Efficacy*, factor two represents *Career and Academic Development Self-Efficacy*, factor three represents *Personal/Social Development Self-Efficacy*, and factor four represents *Collaboration Self-Efficacy*. The original theorized structure of the SCSEs included a subscale on *Cultural Awareness Self-Efficacy*; however, the results of the analyses did *not* support the *Cultural Awareness Self-Efficacy* with these data. A review of the SCSEs items (e.g., question content) and theoretical groundwork (e.g., Bodenhorn & Skaggs, 2005) supported the assignment of factor labels.

The following section presents the Cronbach's alphas to assess the internal consistency reliability of the modified SCSEs with these data. Cronbach's α for the entire modified SCSEs scale (*all 12 items*) was .880, which was acceptable (Hair et al., 2006). Regarding the four modified SCSEs subscales, the *Leadership and Assessment Self-Efficacy* scale had a Cronbach's

α of .827, the *Career and Academic Development Self-Efficacy* scale had a Cronbach's α of .767, the *Personal/Social Development Self-Efficacy* scale had a Cronbach's α of .745, and *Collaboration Self-Efficacy* scale had a Cronbach's α of .601. Therefore, three of the SCSEs subscales had an acceptable internal reliability coefficient and one subscale (*Collaboration Self-Efficacy*) had a moderate to questionable Cronbach's α with these data (Hair et al., 2006).

Table 28 *Exploratory Factor Analysis of the SCSEs*

Item	Factor				Comm.
	1	2	3	4	
SCSE_36	0.886	0.069	-0.085	-0.096	.656
SCSE_37	0.761	0.003	0.063	0.003	.653
SCSE_41	0.646	-0.098	0.140	0.105	.583
SCSE_12	-0.070	0.923	0.066	-0.062	.793
SCSE_13	0.152	0.561	-0.118	0.121	.444*
SCSE_11	-0.002	0.532	0.137	0.075	.476
SCSE_18	0.020	-0.024	0.744	-0.046	.504
SCSE_21	-0.016	0.058	0.696	0.030	.559
SCSE_23	0.098	0.095	0.511	0.048	.473*
SCSE_6	-0.118	0.005	0.012	0.704	.414*
SCSE_2	0.079	-0.007	0.053	0.507	.355*
SCSE_4	0.114	0.107	-0.069	0.477	.347*
<i>Eigenvalue</i>	5.28	1.10	.93*	.80*	
<i>Variance (%)</i>	44.02	9.17	7.79	6.68	

* Denotes low commonalities and eigenvalues

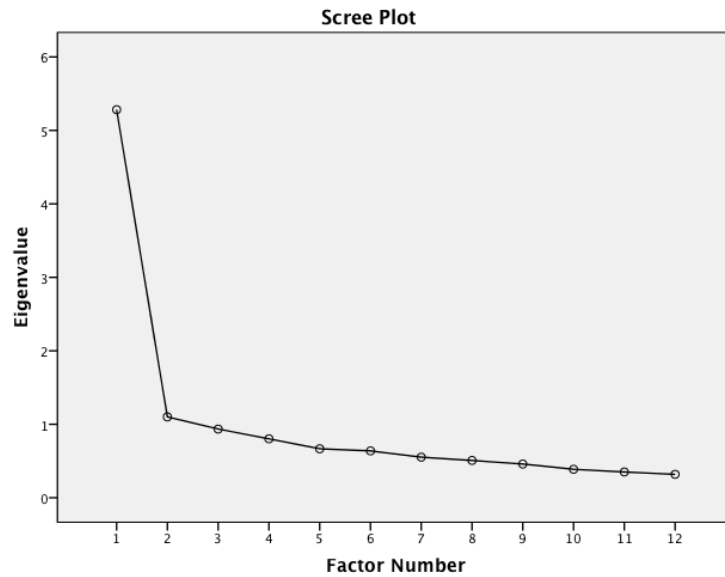

Figure 13: Scree plot for the SCSEs

Originally, the SCSEs was tested with these data but did *not* specify and did *not* meet the cutoff criteria for the specified fit indices for this data (see table 29). Therefore, the SCSEs model was modified based upon the results of the EFA. Next, the researcher conducted a CFA on the modified SCSEs measurement model with these data. All the SCSEs items on the modified measurement model had significant factor loadings ranging from .57 to .80 (Comrey & Lee, 1992; Stevens, 1992; Tabachnick & Fidell, 2006). The standardized residual covariance matrix produced one covariance greater than 1.96; however, it was within acceptable range (e.g., < 2.58) to support the strength of the SCSEs model (Schumacher & Lomax, 2010). Furthermore, the model aligned with O'Brien's (1994) criteria for an identified measurement model. The respecified SCSEs model provided a good fit for the SCSE with these data (see table 29).

Table 29 Model fit Indices of the SCSEs

	χ^2	df	p	GFI	CFI	RMSEA	SRMR
Theorized Measurement Model	2788.11	850	.000	.799	.821	.063	.058
Respecified Measurement Model (Figure 14)	68.35	48	.028	.968	.966	.027	.035

Note. The original model was estimated using ML because WLS requires fewer parameters per sample size. The respecified model was estimated using WLS.

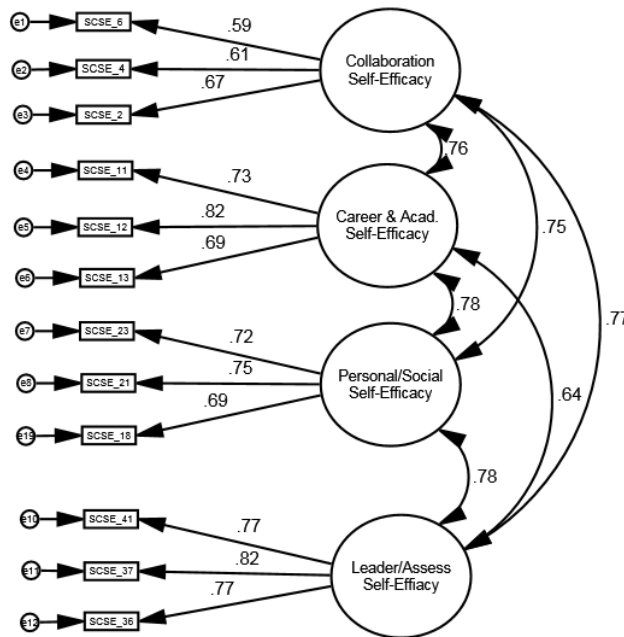

Figure 14: Modified Measurement Model for the SCSEs

Factor Analysis for School Counselor Programmatic Service Delivery

School counselors' programmatic service delivery was measured using the SCARS (Scarsborough, 2005). The theoretical structure of the SCARS was constructed based upon previous research that identified a five factor model (e.g., Scarsborough, 2005). After initial review of the data using CFA, many of the SCARS items did *not* fit the theorized structure due to high standardized residual covariance, low factor loadings, or poor goodness of fit with these data (Schumacher & Lomax, 2010). Accordingly, to identify the factors of service delivery an EFA was conducted. The EFA of the 48-item SCARS employed the extraction procedure of

principal axis factoring (due to non-normality) with Promax rotation (Costello & Osborne, 2005; Fabrigar et al., 1999; Hair et al., 2006). First, the researcher eliminated SCARS items based upon: (a) low factor loadings ($< .30$), (b) low commonality ($< .5$), and (c) cross-loading on more than one factor (Hair et al., 2006), resulting in the elimination of 33 items. Next, the researcher re-loaded each SCARS item to assess for the strongest model, resulting in the addition of two items (total of 12 items).

Traditionally, the criterion to determine the number of factors in the SCARS model was based upon the number of factors with an eigenvalue one or higher (e.g., Kaisers rule; Mertler & Vannatta, 2005). However, the resulting factor identification was *not* theoretically sound. Therefore, the researcher forced a three factor and four factor SCARS model to examine a theoretical and data driven factor identification. The percent variance explained was also examined with a four-factor SCARS model accounting for 74.40% of total variance, which was satisfactory in social science research (Hair et al., 2006). The Scree Plot was examined and the researcher determined a break that verified a four-factor solution was best for the SCARS with these data (see figure 15; Hair et al., 2006). Bartlett's test of Sphericity produced a statistically significant value ($\chi^2 = 4241.96$, $df = 78$, $p < .001$), which indicates that the data were correlated. The analysis produced a KMO measure of sampling adequacy index of .88, which is considered commendable (Dimitrov, 2012; Hair et al., 2006). The commonalities were acceptable with four of them below .5 (see table 30; Hair et al., 2006). SCARS factor one represents *Curriculum Service Delivery*, factor two represents *Counseling Service Delivery*, factor three represents *Consultation Service Delivery*, and factor four represents *Coordination Service Delivery*. The original theorized structure of the SCARS included a subscale on *Other Activities*; however, the *Other Activities* subscale was *not* supported with these data, which is similar to Shillingford and

Lambie's (2009) finding. The researcher attempted to include the SCARS *Other Activities* subscale in the EFA but the items were removed based upon elimination criteria (noted earlier). In addition, the researcher attempted to run an EFA on the SCARS *Other Activities* subscale independent of the other items but the factor solution was *not* suitable for consideration due to low factor loadings and fewer than three items loading on a single factor (Hair et al., 2006). Therefore, the *Other Activities* subscale and its associated items were *not* included in the SCARS measurement model with these data (similar to Shillingford & Lambie, 2010). A review of the SCARS items (e.g., question content) and theoretical groundwork (e.g., Scarborough, 2005) supported the assignment of factor labels.

The following section presents the Cronbach's alphas to assess the internal consistency reliability of the modified SCARS measurement model with these data. Cronbach's α for the entire modified SCARS scale (*all 13 items*) was .891, which was acceptable (Hair et al., 2006). Regarding the four modified SCARS subscales, the *Curriculum Service Delivery* scale had a Cronbach's α of .933, the *Counseling Service Delivery* scale had a Cronbach's α of .844, the *Consultation Service Delivery* scale had a Cronbach's α of .742, and *Coordination Service Delivery* scale had a Cronbach's α of .748. All four of the SCARS subscales scales had acceptable internal reliability coefficient with these data (Hair et al., 2006).

Table 30 Exploratory Factor Analysis of the SCARS

Item	Factor				Comm.
	1	2	3	4	
SCARS_23	0.939	0.021	-0.025	0.000	.891
SCARS_20	0.919	0.047	-0.004	-0.049	.850
SCARS_22	0.872	-0.038	0.033	0.017	.759
SCARS_25	0.786	-0.047	0.027	0.050	.633
SCARS_5	0.049	0.912	-0.035	-0.008	.849
SCARS_7	0.052	0.762	0.019	-0.005	.640
SCARS_6	-0.088	0.715	0.045	0.022	.490*
SCARS_12	-0.026	0.013	0.811	-0.060	.610
SCARS_14	0.041	-0.006	0.682	0.002	.483*
SCARS_13	0.030	0.026	0.565	0.096	.416*
SCARS_28	-0.093	0.003	0.057	0.824	.657
SCARS_31	0.040	-0.025	-0.009	0.713	.515
SCARS_27	0.169	0.056	-0.065	0.528	.402*
Eigenvalue	5.67	1.70	1.23	1.07	
Variance (%)	43.61	13.08	9.46	8.25	

* Denotes low commonalities.

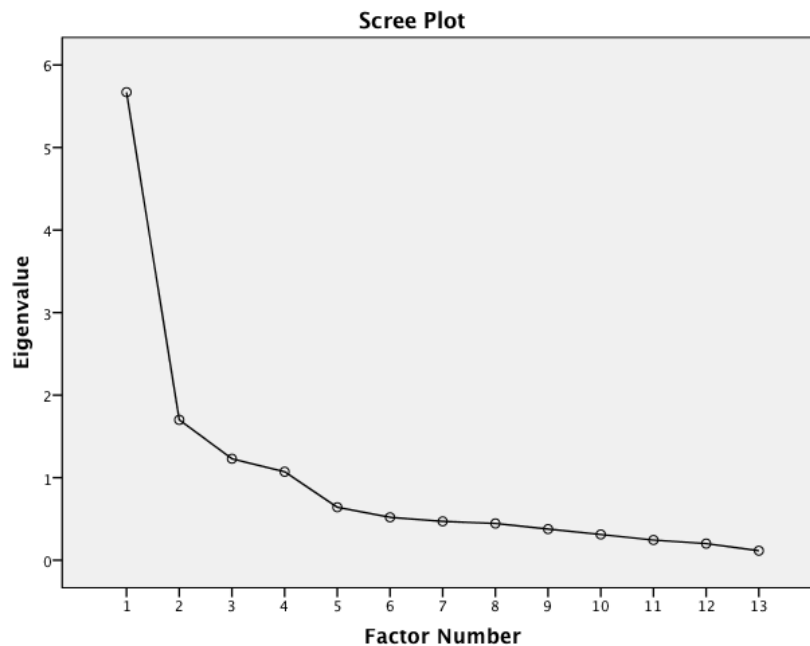

Figure 15: Scree plot for the SCARS

Initially, the SCARS was tested with these data; however, the data did *not* specify and did *not* meet the cutoff criteria for the specified fit indices for this data (see table 31). Therefore, the SCARS model was modified based upon the results of the EFA. Next, the researcher conducted a CFA on the modified SCARS measurement model with these data. All items on the modified SCARS measurement model had significant factor loadings ranging from .57 to .80 (Comrey & Lee, 1992; Stevens, 1992; Tabachnick & Fidell, 2006). The standardized residual covariance matrix produced several covariance greater than 1.96; however, it was within acceptable range (e.g., < 2.58) to support the strength of the model (Schumacher & Lomax, 2010). Furthermore, the SCARS model aligned with O'Brien's (1994) criteria for an identified measurement model. The respecified model provided a good fit for the SCARS (see table 31).

Table 31 *Model fit Indices of the SCARS*

	χ^2	<i>df</i>	<i>p</i>	GFI	CFI	RMSEA	SRMR
Theorized Measurement Model	4568.50	1070	.000	.709	.731	.075	.092
Respecified Measurement Model (figure 16)	125.90	71	.000	.970	.963	.037	.035

Note. The original model was estimated using ML because WLS requires fewer parameters per sample size. The respecified model was estimated using WLS.

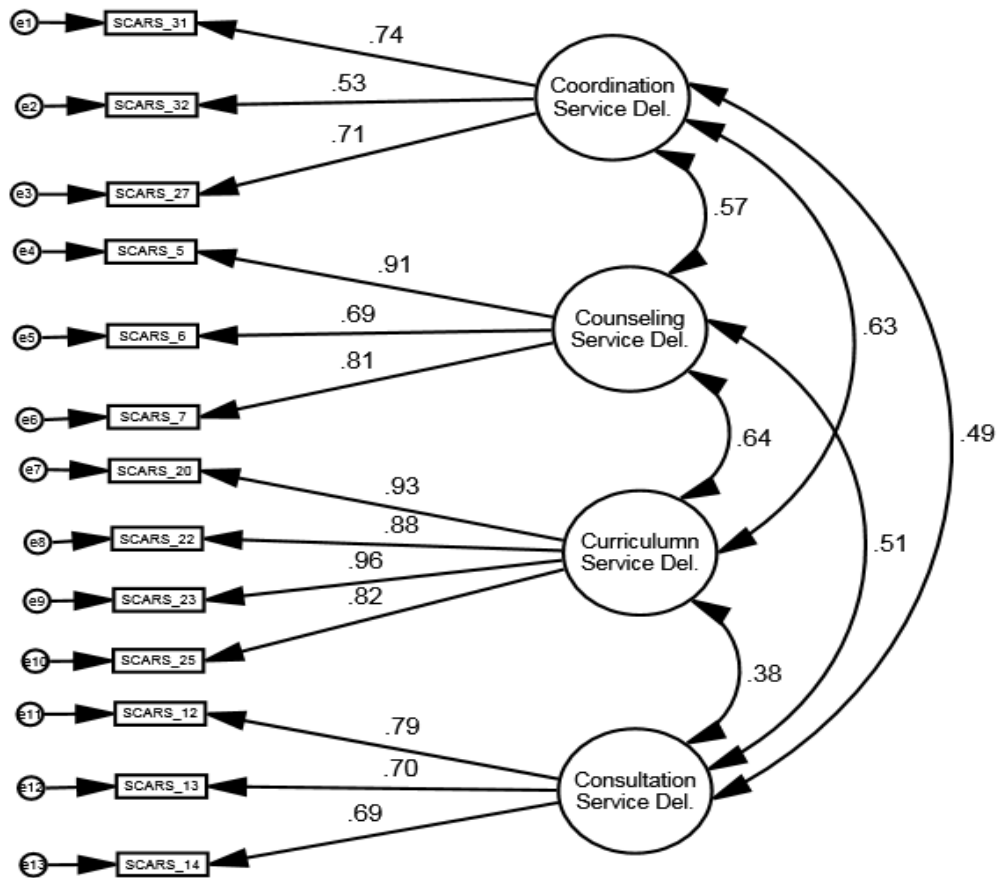

Figure 16: Modified Measurement Model for the SCARS

Complete Measurement Model

A complete measurement model examines the compilation of the measurement models from the instruments used in the study with the goal of explaining links between indicators and latent factors (Bryne, 2010; Schumacher & Lomax, 2010). The complete measurement model for the study at hand produced a good fitting model that did *not* need any modifications (see table 32).

Table 32 Model fit Indices of the Full Measurement Model

	χ^2	df	p	GFI	CFI	RMSEA	SRMR
Full Measurement Model	775.99	505	.000	.931	.969	.031	.036

Note. The Full Measurement Model was developed using ML estimation due to the complexity of the model and the sample size.

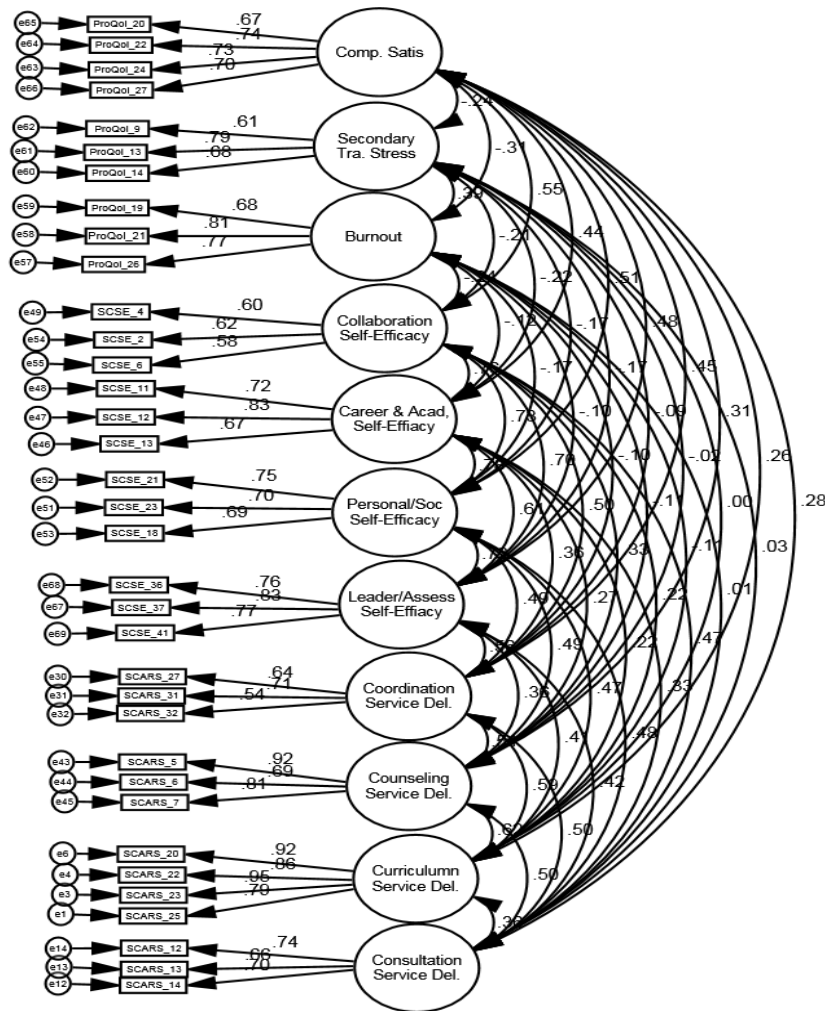

Figure 17: Modified Measurement Model for the SCARS

Complete Parceled Measurement Model

A complete parceled measurement model examines the compilation of the parceled measurement models from the instruments used in the study with the goal of explaining links

between composite score indicators and latent factors (Bryne, 2010; Schumacher & Lomax, 2010). The complete parceled measurement model for the study at hand produced a good fitting model that did *not* need any modifications (see table 33).

Table 33 *Model fit Indices of the Full Measurement Model*

	χ^2	df	p	GFI	CFI	RMSEA	SRMR
Full Parceled Measurement Model	199.78	41	.000	.939	.912	.082	.058

Note. The Parceled Measurement Model was developed using ML estimation due to the complexity of the model and the sample size.

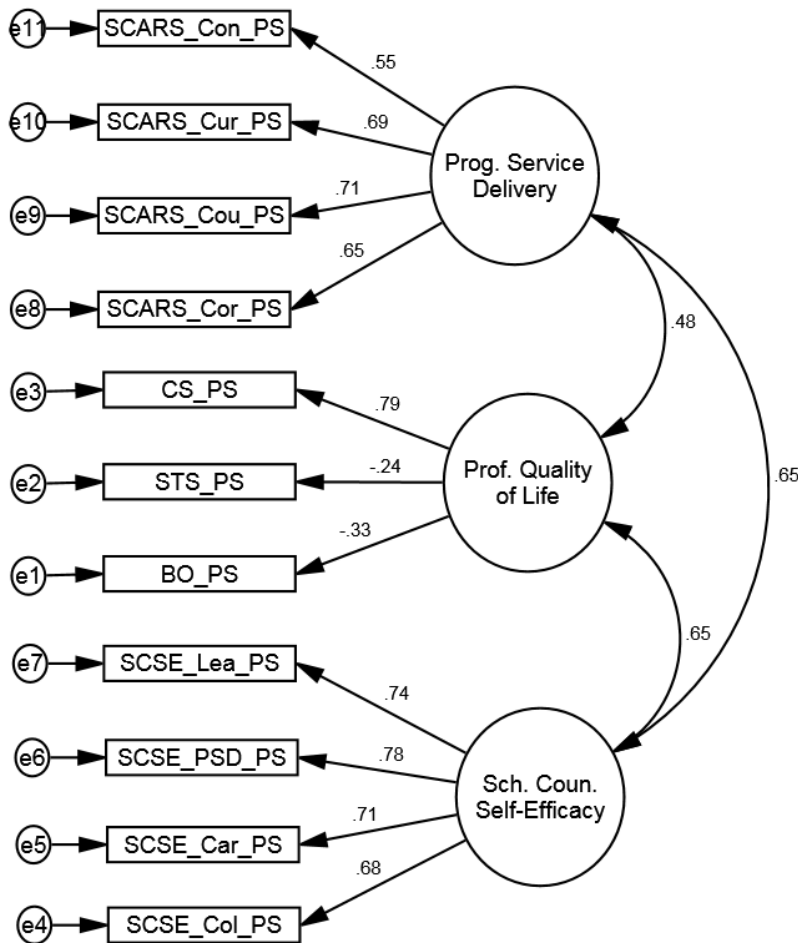

Figure 18: Complete Parceled Measurement Model

Structural Model

The hypothesized structural model (see figure 16) was specified based upon the measurement model (see figure 15). The hypothesized structural model included composite indicators formed from the parceled scores of the modified measurement models previous noted. Specifically, the latent construct of *professional quality of life*, an Exogenous/Independent Variable, was formed from the modified measurement model for the ProQOLs (see figure 12), including the following indicators: (a) *Compassion Satisfaction* (CS_PA), (b) *Secondary Traumatic Stress* (STS_PA), and (c) *Burnout* (BO_PA). The latent construct of *school counselor self-efficacy*, an Exogenous/Independent Variable, was formed from the modified measurement model for the SCSEs (see figure 14), including the following indicators: (a) *Collaboration Self-Efficacy* (SCSE_Col_PA), (b) *Career and Academic Development Self-Efficacy* (SCSE_Car_PA), (c) *Personal/Social Development Self-Efficacy* (SCSE_PSD_PA), and (d) *Leadership/Assessment Self-Efficacy* (SCSE_Lea_PA). The latent construct of *programmatic service delivery*, an Endogenous/Dependent Variable, was formed from the modified measurement model for the SCARS (see figure 16), including the following indicators: (a) *Coordination* (SCARS_Cor_PA), (b) *Counseling* (SCARS_Cou_PA), (c) *Curriculum* (SCARS_Cur_PA), and (d) *Consultation* (SCARS_Con_PA). The hypothesized model was specified with direct paths from professional quality of life and school counselor self-efficacy to programmatic service delivery. In addition, school counselor professional quality of life and self-efficacy were allowed to covary, as it was assumed that professional quality of life and self-efficacy would correlate.

The initial hypothesized structural model ($p < .001$) was tested and *minimal* support was found $\chi^2(41, N = 577) = 199,778$, GFI = .939, CFI = .912, RMSEA = .082, and SRMR = .058. The hypothesized structural model (see figure 10) did *not* meet the CFI fit index cutoff ($\geq .95$)

and the RMSEA cutoff criteria ($\leq .8$). Therefore, post hoc modifications were made based upon the modification indices. The error for items 1 and 2, 4 and 5, 6 and 7, and 10 and 11 were freed. The freeing of these factor items was supported by theoretical background of the indicators. The resulting modified structural model (see figure 19) led to a strong model fit (see table 34).

Table 34 Model fit Indices of all Parceled Structural Models

	χ^2	df	p	GFI	CFI	RMSEA	SRMR
Initial Structural Model	199.78	41	.000	.939	.912	.082	.058
Modified Structural Model	120.798	37	.000	.963	.953	.063	.045
Modified Respecified Structural Model	105.637	29	.000	.965	.956	.068	.043

Note. The Parceled Structural Model was developed using Maximum Likelihood estimation due to the complexity of the model and the sample size.

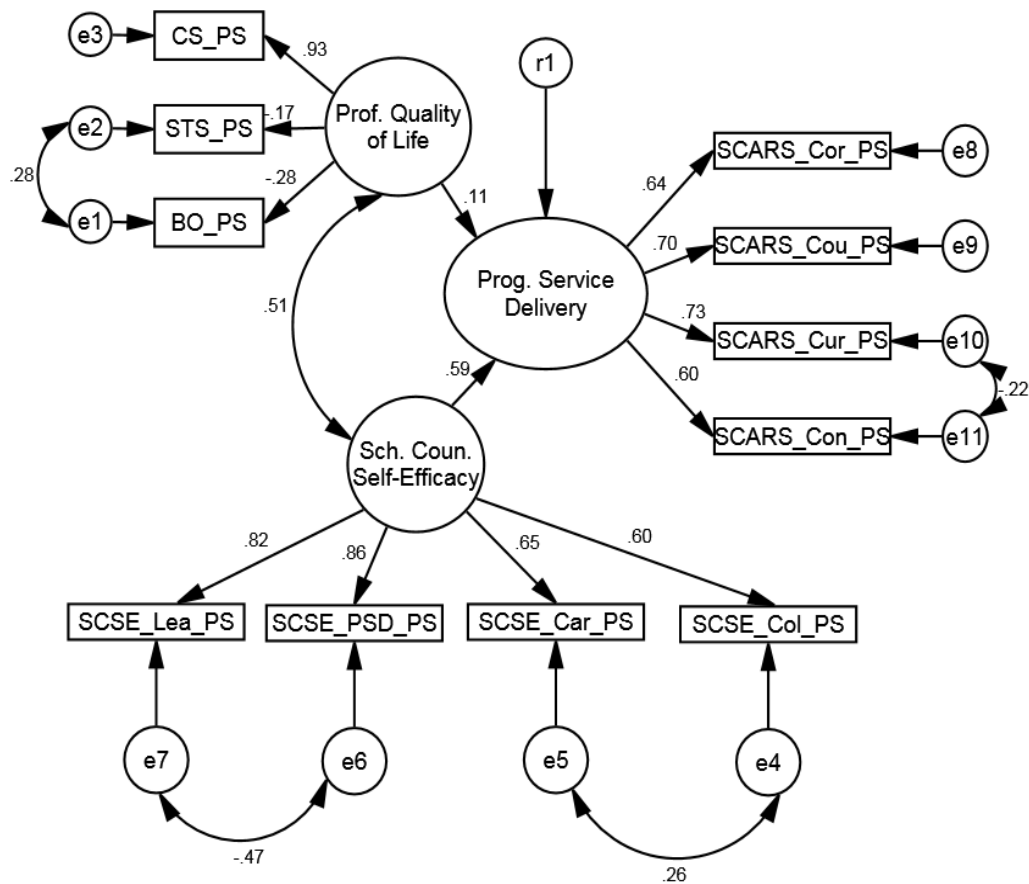

Figure 19: Modified Structural Model

The modified structural model ($p < .001$) was tested and support was found $\chi^2(37, N = 577) = 120.798$, GFI = .963, CFI = .953, RMSEA = .063, and SRMR = .045. All hypothesized direct relations were statistically significant ($p < .001$) and the covariance between school counselor self-efficacy and professional quality of life was statistically significant ($p < .001$). The modified model was informative in regards to the amount of variance that was accounted by the latent constructs. Specifically, professional quality of life accounts for 1.21% (standardized coefficient = .11) of the variance for programmatic service delivery, which is of little practical significance (Cohen, 1988). However, school counselor self-efficacy accounts for 34.81% (standardized coefficient = .59) of variance for programmatic service delivery. In addition, the covariance of professional quality of life and school counselor self-efficacy accounted for 26% of the variance between the two constructs (standardized coefficient = .51). The results relating to professional quality of life should be interpreted with caution because the manifest variable of *Secondary Traumatic Stress* (STS_PA) has a low loading factor ($< .20$; Kline, 2011), indicating that the composite score for *Secondary Traumatic Stress* was *not* providing a sufficient explanation with these data. In addition, the relationship of professional quality of life to programmatic service delivery and self-efficacy should be interpreted with care because of the low factor loading from the composite score of *Secondary Traumatic Stress*. Nevertheless, the other two composite scores for professional quality of life were loading at high levels. Consequently, the researcher conducted a second post hoc modification by removing the manifest variable *Secondary Traumatic Stress* and re-analyzed the modified model (see table 35 and figure 20).

Table 35 Model fit Indices of all Parceled Structural Models

	χ^2	df	p	GFI	CFI	RMSEA	SRMR
Initial Structural Model	199.78	41	.000	.939	.912	.082	.058
Modified Structural Model	120.798	37	.000	.963	.953	.063	.045
Modified Respecified Structural Model	105.637	29	.000	.965	.956	.068	.043

Note. The Parceled Structural Model was developed using Maximum Likelihood estimation due to the complexity of the model and the sample size.

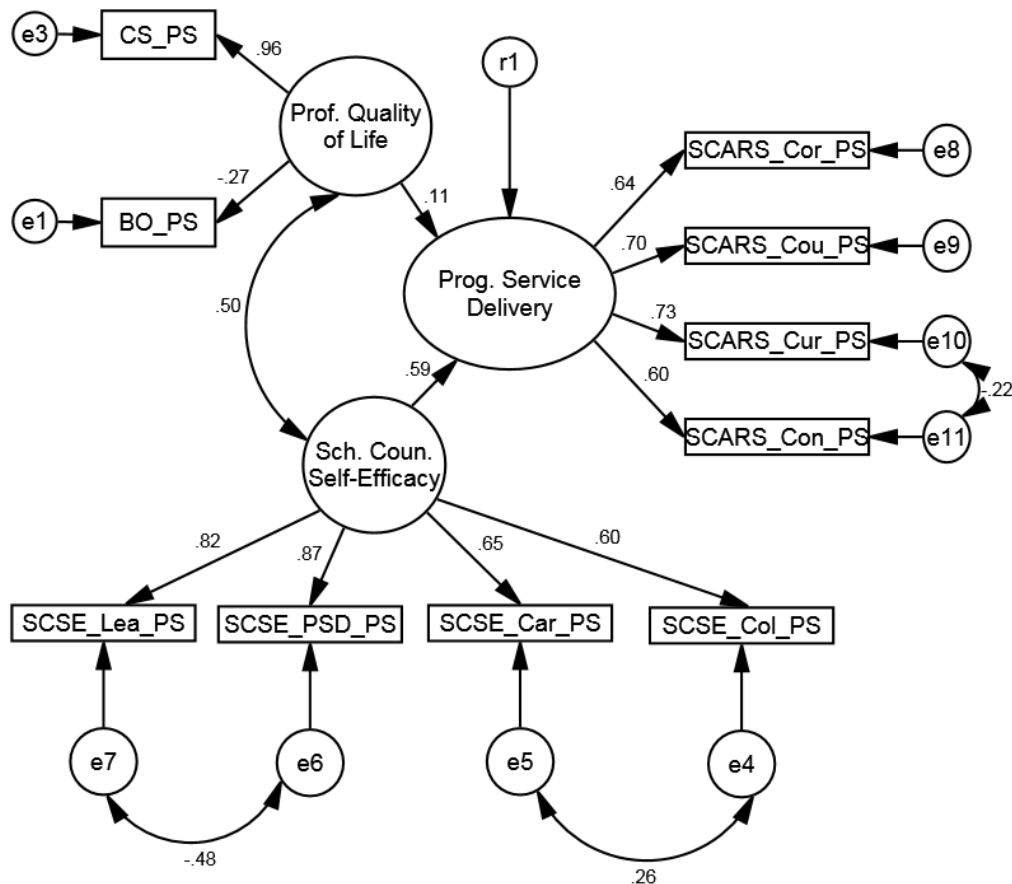

Figure 20: Modified Respecified Structural Model

The second modified structural model ($p < .001$) was tested and support was found $\chi^2(29, N = 577) = 105.637$, GFI = .965, CFI = .956, RMSEA = .068, and SRMR = .043 (see table 34).

All hypothesized direct relations were statistically significant ($p < .001$) and the covariance between school counselor self-efficacy and professional quality of life was statistically significant ($p < .001$). Specifically, professional quality of life still accounts for 1.21%

(standardized coefficient = .11) of the variance for programmatic service delivery and school counselor self-efficacy still accounts for 34.81% (standardized coefficient = .59) of variance for programmatic service delivery. However, a small change occurred for the covariance of professional quality of life and school counselor self-efficacy to account for 25% of the variable between the constructs (standardized coefficient = .50). However, the removal of the manifest variable of *Secondary Traumatic Stress* resulted in professional quality of life having two indicators, which does *not* support model identification (Bollen, 1989; O'Brien, 1994). The researcher concluded that the first modified structure model, although having a low loading factor on professional quality of life, was the better of the two structural models for these data.

Further examination for the structural model provided information about the relationships between the latent constructs. The positive relationship between professional quality of life and programmatic service delivery identified that school counselors who have higher professional quality of life also had higher frequency of providing programmatic service delivery. Also, the positive covariance between professional quality of life and school counselor self-efficacy identified that counselors who have higher professional quality of life also had higher levels of self-efficacy. Furthermore, the positive relationship between self-efficacy and programmatic service delivery identified that school counselors with high self-efficacy complete service delivery tasks at a higher frequency ($r = .59$; 34.81% of the variance explained). Overall, the structural model established good model fit and provides relevant information in regards to the measured constructs.

Follow Up Analyses

Additional analyses were conducted to further explore the hypothesized model being examined. The art of searching for the existence of equivalent models is considered good

practice (Kline, 2011). Therefore, the researcher tested a second-order structural model to examine if it is a better fit.

Complete Second-Order Measurement Model

A complete second-order measurement model was used to examine the compilation of the measurement models from the instruments used in the study with the goal of explaining links between indicators and latent factors on the first and second order (Bryne, 2010; Schumacher & Lomax, 2010). The complete second-order measurement model for the study at hand produced a good fitting model that did *not* need any modifications (see table 36).

Table 36 *Model fit Indices of the Full Measurement Model*

	χ^2	<i>df</i>	<i>p</i>	GFI	CFI	RMSEA	SRMR
Full Second-Order Measurement Model	979.47	546	.000	.912	.951	.037	.054

Note. The Full Second-Order Measurement Model was developed using ML estimation due to the complexity of the model and the sample size.

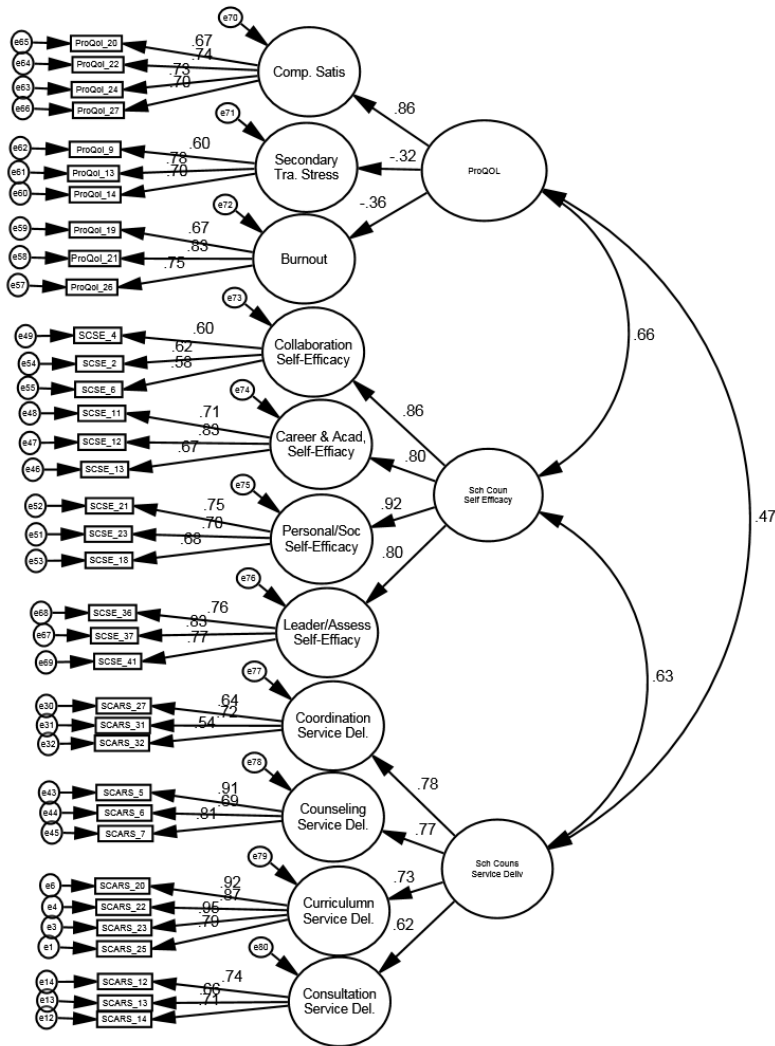

Figure 21: Complete Second-Order Measurement Model

Second-Order Structural Model

The hypothesized structural model involved the use of parceling, which is a much-debated topic in SEM research (Little et al., 2002). Parceling can be beneficial for data that violates normal distribution and can bring parsimony to complex models (Bovaird & Koziol, 2012; Kline, 2011; Little et al., 2002). However, parceling has several consequences, including the masking of dimensionality and model misspecification (Little et al., 2002). Furthermore, parceling can result in loss of information and limited range that may bias correlations and

covariance (Bovaird & Koziol, 2012). Consequently, exploring a structural model that does *not* parcel the indicators may reveal different results.

The follow-up second order structural model (see figure 21) was specified based upon the aforementioned measurement models (see figure 22). The follow-up second order structural model included latent variables formed from the manifest variables based on the modified measurement models previous noted. Specifically, the second order latent construct of *professional quality of life*, an Exogenous/Independent Variable, was formed from the modified measurement model for the ProQOLs (see figure 12), including the following first order latent constructs: (a) *Compassion Satisfaction*, (b) *Secondary Traumatic Stress*, and (c) *Burnout*. The latent construct of *self-efficacy*, an Exogenous/Independent Variable, was formed from the modified measurement model for the SCSEs (see figure 14), including the following first order latent constructs: (a) *Collaboration Self-Efficacy*, (b) *Career and Academic Development Self-Efficacy*, (c) *Personal/Social Development Self-Efficacy*, and (d) *Leadership/Assessment Self-Efficacy*. The latent construct of *programmatic service delivery*, an Endogenous/Dependent Variable, was formed from the modified measurement model for the SCARS (see figure 16), including the following first order latent constructs: (a) *Coordination*, (b) *Counseling*, (c) *Curriculum*, and (d) *Consultation*. The hypothesized second order model was specified with direct paths from professional quality of life and school counselor self-efficacy to programmatic service delivery. In addition, school counselor professional quality of life and self-efficacy were allowed to covary, because it was theoretically assumed that these professional quality of life and self-efficacy would correlate.

The initial second-order model ($p < .001$) was tested and support was found $\chi^2 (546, N = 577) = 979.47$, GFI = .912, CFI = .951, RMSEA = .037, and SRMR = .054. All hypothesized

direct relations were statistically significant ($p < .001$) and the covariance between self-efficacy and professional quality of life was statistically significant ($p < .001$). The initial second-order structural model (see figure 22) resulted in a model that had good fit (see table 37). In contrast with the parceled hypothesized model, the second-order model, as compared to the parceled version, had a higher factor loading (.32 versus .17) for the latent construct of *Secondary Traumatic Stress* (was a manifest variable on the hypothesized model). In addition, eight out of the ten factor loadings contributing to professional quality of life, self-efficacy and service delivery had greater values on the second-order structural model in comparison to the hypothesized structural model.

Table 37 *Model fit Indices of all Structural Models*

	χ^2	<i>df</i>	<i>p</i>	GFI	CFI	RMSEA	SRMR
Initial Structural Model	199.78	41	.000	.939	.912	.082	.058
Modified Structural Model	120.798	37	.000	.963	.953	.063	.045
Modified Respecified Structural Model	105.637	29	.000	.965	.956	.068	.043
Second Order Structural Model	979.47	546	.000	.912	.951	.037	.054

Note. The Structural Model was developed using Maximum Likelihood estimation due to the complexity of the model and the sample size.

The second order structural model was informative in regards to the amount of variance that was accounted by the latent constructs, including professional quality of life accounting for 1.00% (standardized coefficient = .10) of the variance for programmatic service delivery, which is of little practical significance (Cohen, 1988). However, school counselor self-efficacy accounts for 32.49% (standardized coefficient = .57) of variance for programmatic service delivery. Furthermore, the correlation of the latent variables of professional quality of life and school counselor self-efficacy accounts for 43.56% of their variance (standardized coefficient = .66). Interestingly, the relationship of professional quality of life to programmatic service

delivery and school counselor self-efficacy were similar for the second-order structural as compared to the hypothesized parceled structural model. Furthermore, as school counselors' reported higher professional quality of life: (a) they completed more service delivery activities and (b) they had higher self-efficacy. The increased strength of the factor loadings for the first-order latent variables was the main difference between the two structural models; resulting in the researcher committing to the second-order structural model as a better representation of the model as compared to the parceled model with these data.

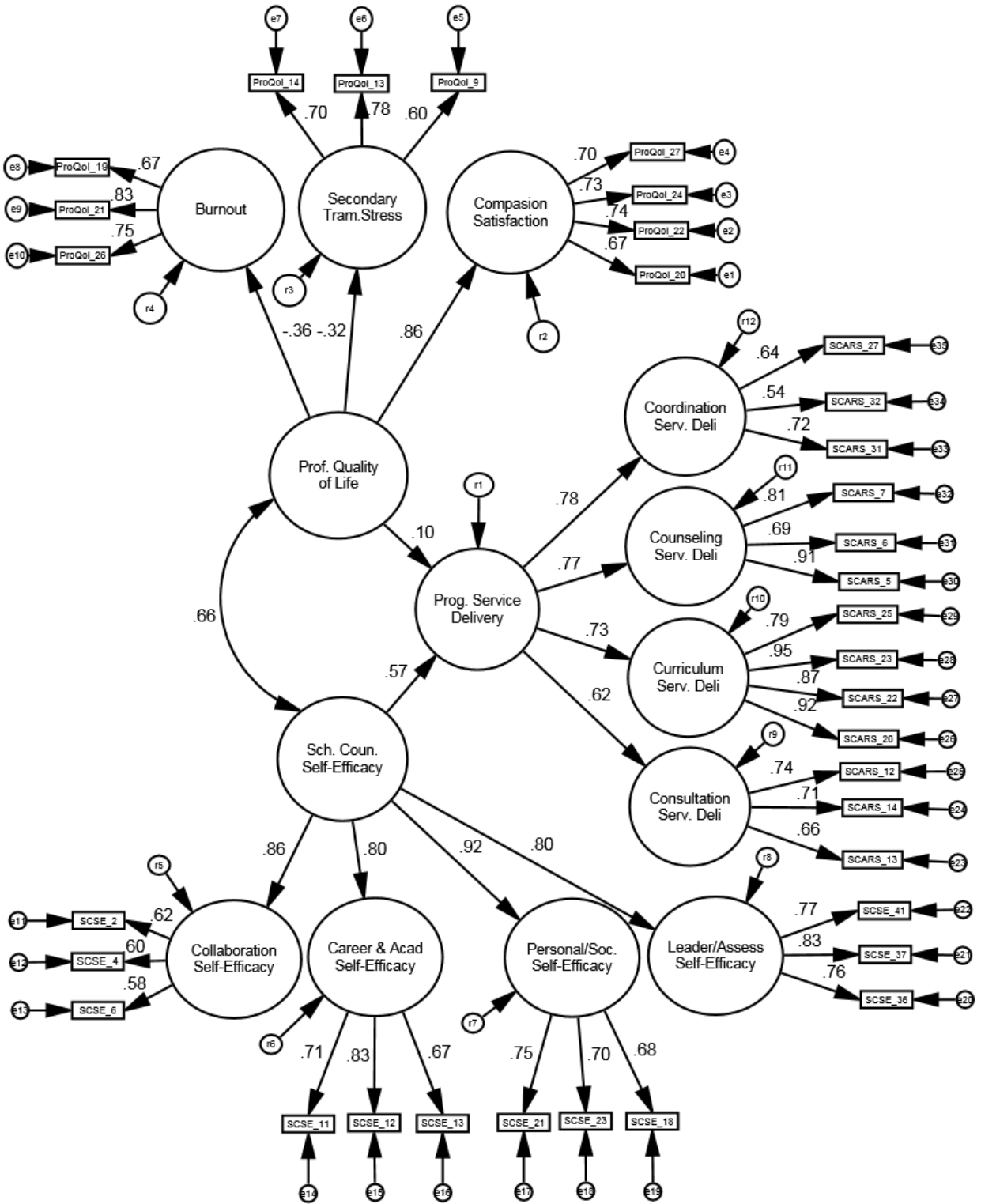

Figure 22: Modified Second-Order Structural Model

Standard Multiple Regression

Multiple linear regression (MLR) analysis was conducted between frequency of programmatic service delivery as the dependent variable and school counselors' self-efficacy and professional quality of life as the independent variables. The total scores of the modified data collection instruments (e.g., SCSEs, ProQOLs, and SCARS) based on the respecified measurement models was analyzed using MLR. After reviewing the statistical assumptions, the researcher transformed the variables (averaged subscales) to reduce skewness and kurtosis to improve the normality assumption. Power transformation was used on *all* the variables, which improved data such that the assumption of normality was met. Next, *no* outliers were detected with a $p < .001$ criterion of Mahalanobis' distance. In addition, the missing data was already screened and the VIF and Tolerance were within range to support *no* multicollinearity.

Overall, the linear composite of the predictor variables (modified SCSE and ProQOLs total score) predicted approximately 24.9% ($r = .499$) of the variance in the school counselors' frequency of programmatic service delivery, $F(2, 574) = 94.98, p < .001$. Both predictor variables had statistically significant beta coefficients for the dependent variable frequency of programmatic service delivery. School counselor self-efficacy had the highest beta value ($\beta = .481, p < .001$) and professional quality of life had the next highest beta value ($\beta = .092, p = .012$).

To further examine the data, the researcher explored the bivariate correlations of the total scale scores for the modified data collection instruments (e.g., SCSEs, ProQOLs, and SCARSs) using Pearson-Moment correlation coefficients. Table 38 presents the Pearson-Moment correlation coefficients.

Table 38 *Pearson-Moment Correlations*

	ProQOLs	SCSEs	SCARS
ProQOLs	1	.097*	.138***
SCSEs	.097*	1	.489***
SCARS	.138***	.489***	1

$p < .05^*$, $p < .01^{**}$, $p < .001^{***}$

Exploratory Research Questions

Exploratory Research Question One

Is there a statistically significant relationship between schools counselors' levels self-efficacy (as measured by the *SCSEs* [Bodenhorn & Skaggs, 2005]) and their reported demographic variables (e.g., age, gender, and ethnicity)?

Participants' level of self-efficacy was measured by the *SCSEs* (Bodenhorn & Skaggs, 2005), which includes five subscales (e.g., Personal/Social Development, Leadership/Assessment, Career/Academic Development, Collaboration, and Cultural Awareness) and a total score. To investigate the relationship between demographic variables and the respondents' self-efficacy a Spearman Rank Order correlation was used. Prior to the analysis, the data was examined to test for statistical assumptions. The skewness and kurtosis of the data indicated univariate non-normality. The $Z_{skewness}$ value for the *SCSEs* scales ranged from 2.01 to 4.62 and the $Z_{kurtosis}$ value ranged from 1.57 to 3.69. Therefore, the Spearman Rank Order correlation analysis was selected because it is a non-parametric (e.g., doesn't rely on a distribution) method to analyze relationships between two variables. In addition, the Spearman Rank Order Correlation is an appropriate analysis for nominal (categorical) data (i.e., gender, ethnicity, and grade level served; Pallant, 2010). Furthermore the rho (ρ) correlation statistics was evaluated based upon Cohen's (1988) recommended interpretations of the relationships. The relationships were analyzed utilizing *all* of the items from the data collection instruments and

not the modified version from the SEM analysis. The Cronbach's alphas for the SCSEs were presented earlier in this chapter. The analyses were organized into three categories: (a) Participants Characteristics, (b) Setting Characteristics, and (c) Other Demographic Information.

The relationships identified between the school counselors' reported demographic data and their self-efficacy are presented in Table 39. The school counselors' reported demographic characteristics of gender, highest degree earned, and training program CACREP status did *not* identify any statistically significant results, indicating that these topics did *not* relate to respondents' self-efficacy scores for these data. Age was statistically significant with the SCSEs total score ($\rho = .118, p < .01$; 1.4% of the variance explained), personal social development self-efficacy ($\rho = .152, p < .001$; 2.3% of the variance explained), and collaboration self-efficacy ($\rho = .160, p < .001$; 2.6% of the variance explained) but *not* leadership and assessment self-efficacy, career and academic development self-efficacy, and cultural awareness self-efficacy. Ethnicity was statistically significant with the SCSEs total score ($\rho = -.100, p < .05$; 1.0% of the variance explained), leadership and assessment self-efficacy ($\rho = -.091, p < .05$; .01% of the variance explained), career and academic development self-efficacy ($\rho = -.095, p < .05$; 1.9% of the variance explained), and cultural awareness self-efficacy ($\rho = -.109, p < .01$; 1.2% of the variance explained), but *not* personal social development self-efficacy and collaboration self-efficacy. The amount of years of experience as a school counselor was statistically significant with total SCSEs score ($\rho = .114, p < .01$; 1.3% of the variance explained), personal social development self-efficacy ($\rho = .137, p < .01$; 1.9% of the variance explained), and collaboration self-efficacy ($\rho = .155, p < .001$; 2.4% of the variance explained) but *not* leadership and assessment self-efficacy, career and academic development self-efficacy, and cultural awareness self-efficacy. The amount of years of experience as a teacher was statistically significant with leadership and development

self-efficacy ($\rho = .097, p < .05$; 1.0% of the variance explained) and career and academic development self-efficacy ($\rho = .111, p < .008$; 1.2% of the variance explained) but *not* the SCSEs total score, personal social development self-efficacy, collaboration self-efficacy, and cultural awareness self-efficacy. Last, ASCA memberships status (e.g., whether a respondent was a member of ASCA or *not*) was found to be statistically significant with SCSEs total score ($\rho = -.202, p < .001$; 4.1% of the variance explained), personal social development self-efficacy ($\rho = -.152, p < .001$; 2.3% of the variance explained), leadership and development self-efficacy ($\rho = -.169, p < .001$; 2.9% of the variance explained), career and academic development self-efficacy ($\rho = -.244, p < .001$; 6.0% of the variance explained), collaboration self-efficacy ($\rho = -.181, p < .001$; 3.3% of the variance explained), and cultural awareness self-efficacy ($\rho = -.110, p < .01$; 1.2% of the variance explained).

To further explore the relationship between ASCA membership status and self-efficacy a Mann-Whitney U Test was conducted. The Mann-Whitney test was chosen because the analysis sought to compare the means of two groups (ASCA Membership Status; *yes* or *no*) with data that was *not* normally distributed and ordinal (e.g., 1-5 Likert Scaling). The resulting analysis identified that there was a difference ($U = 25272; Z = -4.828; p < .001; N = 574; r = .201$) in the distribution of score rankings between respondents holding membership in ASCA ($M_{rank} = 308.91; n = 407$) and respondents *not* currently holding membership in ASCA ($M_{rank} = 235.33; n = 167$). Thus, participants who were members of ASCA report higher levels of school counselor self-efficacy.

Table 39 Spearman Rank Order Correlations Between Demographics Factors and Self-Efficacy, Participant Characteristics

	SCSEs Total Score	Personal Social Develop.	Leadership and Assessment	Career Academic Develop.	Collabo- ration	Cultural Awareness
Gender	NS	NS	NS	NS	NS	NS
Age	$\rho = .118$ $p < .01$	$\rho = .152$ $p < .001$	NS	NS	$\rho = .160$ $p < .001$	NS
Ethnicity	$\rho = -.098$ $p < .05$	NS	$\rho = -.087$ $p < .05$	$\rho = -.093$ $p < .05$	NS	$\rho = -.110$ $p < .01$
Years as a SC	$\rho = .113$ $p < .01$	$\rho = .138$ $p < .01$	NS	NS	$\rho = .156$ $p < .001$	NS
Years as a Teacher	NS	NS	$\rho = .091$ $p < .05$	$\rho = .107$ $p < .05$	NS	NS
Highest Degree	NS	NS	NS	NS	NS	NS
CACREP Graduate	NS	NS	NS	NS	NS	NS
ASCA Member	$\rho = -.197$ $p < .001$	$\rho = -.151$ $p < .001$	$\rho = -.163$ $p < .001$	$\rho = -.241$ $p < .001$	$\rho = -.176$ $p < .001$	$\rho = -.109$ $p < .001$

The relationships between the school setting characteristics and the counselors' self-efficacy scores are presented in Table 40. The setting characteristics of school counseling program type, school type (e.g., regular, career center, special education setting, or alternative education), Title I status, and school location (e.g., urban, suburban, or rural) did *not* identify any statistically significant relationships, indicating that these topics do *not* relate to respondents self-efficacy with these data. School agency type (e.g., public, private, or charter) had a statistically significant relationship with SCSEs total score ($\rho = -.088$, $p < .05$; 1.0% of the variance explained), personal social development self-efficacy ($\rho = -.091$, $p < .05$; 1.0% of the variance explained), and career academic development self-efficacy ($\rho = -.096$, $p < .05$; 1.0% of the variance explained) but *not* leadership and assessment self-efficacy, collaboration self-efficacy, and cultural awareness self-efficacy. Grade levels that participants served had a statistically significant relationship with SCSEs total score ($\rho = -.093$, $p < .05$; 1.0% of the variance

explained) and personal social development self-efficacy ($\rho = -.208, p < .001$; 4.3% of the variance explained), but *not* career academic development self-efficacy, leadership and assessment self-efficacy, collaboration self-efficacy, and cultural awareness self-efficacy.

To further explore the relationship between school counselors' grade level served and their reported personal social development self-efficacy a Kruskal–Wallis test was conducted. The Kruskal–Wallis test was chosen because the analysis sought to compare the means of three groups (Grade Levels) with data that is *not* normally distributed. The resulting analysis identified that there was a statistical difference ($\chi^2 [6] = 35.117; p < .001; N = 571; \eta^2 = .062$) in the distribution of ranked scores between respondents working in an elementary school ($M_{rank} = 336.91; n = 182$), middle school ($M_{rank} = 287.33; n = 164$), high school ($M_{rank} = 236.05; n = 149$), K-8th grade schools ($M_{rank} = 228.57; n = 14$), 6-12th grade schools ($M_{rank} = 232.93; n = 21$), and K-12th grade schools ($M_{rank} = 290.25; n = 42$). Thus, the school counselors who work in elementary settings report the highest level of self-efficacy in regards to personal social development with middle school counselors at the second highest level, and high school at the lowest self-efficacy.

Table 40 *Spearman Rank Order Correlations Between Demographics Factors and Self-Efficacy, Setting Characteristics*

	SCSEs Total Score	Personal Social Develop.	Leadership and Assessment	Career Academic Develop.	Collabo- ration	Cultural Awareness
PSC Program Type	NS	NS	NS	NS	NS	NS
School Type	NS	NS	NS	NS	NS	NS
School Agency Type	$\rho = -.088$ $p < .05$	$\rho = -.091$ $p < .05$	NS	$\rho = -.096$ $p < .05$	NS	NS
Title I Status	NS	NS	NS	NS	NS	NS
School Location	NS	NS	NS	NS	NS	NS
Grade Levels Served	$\rho = -.093$ $p < .05$	$\rho = -.208$ $p < .001$	NS	NS	NS	NS

The relationships between the school counselors' other demographic characteristics and their self-efficacy scores are presented in Table 41. Specifically, the author developed four scales (total $\alpha = .640$) to measure school counselors': (a) principal relationship ($\alpha = .911$), (b) work satisfaction ($\alpha = .710$), (c) work stress ($\alpha = .700$), and (d) perceived job control ($\alpha = .623$). Principal school counselor relationship was found to have a statistically significant relationship with total SCSEs score ($\rho = .257, p < .001$; 6.6% of the variance explained), personal social development self-efficacy ($\rho = .225, p < .001$; 5.1% of the variance explained), leadership and assessment self-efficacy ($\rho = .250, p < .001$; 6.3% of the variance explained), career and academic development self-efficacy ($\rho = .163, p < .001$; 2.7% of the variance explained), collaboration self-efficacy ($\rho = .273, p < .001$; 7.5 % of the variance explained), and cultural awareness self-efficacy ($\rho = .096, p < .05$; 1.0% of the variance explained). Work satisfaction was found to have a statistically significant relationship with total SCSEs score ($\rho = .297, p < .001$; 8.8% of the variance explained), personal social development self-efficacy ($\rho = .271, p < .001$; 7.3% of the variance explained), leadership and assessment self-efficacy ($\rho = .250, p < .001$; 6.3%

of the variance explained), career and academic development self-efficacy ($\rho = .210, p < .001$; 4.4% of the variance explained), collaboration self-efficacy ($\rho = .318, p < .001$; 10.1% of the variance explained), and cultural awareness self-efficacy ($\rho = .216, p < .001$; 4.7% of the variance explained). Work stress was found to have a statistically significant relationship with total SCSEs score ($\rho = -.172, p < .001$; 3.0% of the variance explained), personal social development self-efficacy ($\rho = -.175, p < .001$; 3.1% of the variance explained), leadership and assessment self-efficacy ($\rho = -.148, p < .001$; 2.2% of the variance explained), career and academic development self-efficacy ($\rho = -.171, p < .001$; 2.9% of the variance explained), collaboration self-efficacy ($\rho = -.151, p < .001$; 2.3% of the variance explained), and cultural awareness self-efficacy ($\rho = .086, p < .05$; 1.0% of the variance explained). Perceived job control was found to have a statistically significant relationship with total SCSEs score ($\rho = .288, p < .001$; 8.3% of the variance explained), personal social development self-efficacy ($\rho = .244, p < .001$; 6.0% of the variance explained), leadership and assessment self-efficacy ($\rho = .280, p < .001$; 7.8% of the variance explained), career and academic development self-efficacy ($\rho = .240, p < .001$; 5.8% of the variance explained), collaboration self-efficacy ($\rho = .304, p < .001$; 9.2% of the variance explained), and cultural awareness self-efficacy ($\rho = .138, p < .05$; 1.9% of the variance explained).

To further explore the relationships between principal relationship, work satisfaction, work stress, and perceived job control and self-efficacy, a MLR was conducted. All assumptions were met except for normality of the data. Therefore, the results should be interpreted with caution because the data were *not* normal. The linear composite of the predictor variables (principal relationship, work satisfaction, work stress, and perceived job control) predicted approximately 11.5% ($r = .339$) of the variance in the school counselors' self-efficacy, $F(4, 566)$

= 18.196, $p < .001$. Three of the predictor variables had statistically significant beta coefficients for the dependent variable of self-efficacy and one did *not*. Work satisfaction had the highest beta value ($\beta = .176, p < .001$). Perceived job control had the next highest beta value ($\beta = .156, p = .001$) with work stress next ($\beta = -.095, p = .023$). Principal counselor relationship was *not* statistically significant ($\beta = .053, p = .240$). Therefore, principal relationship, work satisfaction, work stress, and perceived job control and self-efficacy were related to the school counselors' self-efficacy scores.

Table 41. *Spearman Rank Order Correlations Between Demographics Factors and Self-Efficacy, Other Demographic Information*

	SCSEs Total Score	Personal Social Develop.	Leadership and Assessment	Career Academic Develop.	Collabo- ration	Cultural Awareness
Princip-Counsel Relationship	$\rho = .257$ $p < .001$	$\rho = .225$ $p < .001$	$\rho = .250$ $p < .001$	$\rho = .163$ $p < .001$	$\rho = .273$ $p < .001$	$\rho = .096$ $p < .05$
Work Satisfaction	$\rho = .297$ $p < .001$	$\rho = .271$ $p < .001$	$\rho = .250$ $p < .001$	$\rho = .210$ $p < .001$	$\rho = .318$ $p < .001$	$\rho = .216$ $p < .001$
Work Stress	$\rho = -.172$ $p < .001$	$\rho = -.175$ $p < .001$	$\rho = -.148$ $p < .001$	$\rho = -.171$ $p < .001$	$\rho = -.151$ $p < .001$	$\rho = -.086$ $p < .05$
Perceived Job Control	$\rho = .288$ $p < .001$	$\rho = .244$ $p < .001$	$\rho = .280$ $p < .001$	$\rho = .240$ $p < .001$	$\rho = .304$ $p < .001$	$\rho = .138$ $p < .01$

Exploratory Research Question Two

Is there a statistically significant relationship between practicing schools counselors' service delivery (as measured by the SCARS [Scarborough, 2005]) and their demographic variables (e.g., age, gender, and ethnicity)?

The frequency of participants' programmatic service delivery was measured by the SCARS (Scarborough, 2005), which includes five subscales (e.g., Counseling, Consultation, Curriculum, Coordination, and Other Activities [nonessential activities]) and a total score. To investigate the relationship between demographic variables and the respondents' frequency of programmatic service delivery a Spearman Rank Order correlation was used. Prior to the

analysis the data was examined to test for assumptions. The skewness and kurtosis of the data indicated univariate non-normality. The z_{skewness} value for the SCARS scales ranged from .94 to 2.75 and the z_{kurtosis} value ranged from .74 to 5.02. Therefore, the Spearman Rank Order correlation analysis was selected because the Spearman Rank Order correlation is a non-parametric (e.g., doesn't rely on a distribution) method to analyze relationships between two variables (Pallant, 2010). In addition, the Spearman Rank Order Correlation is an appropriate analysis for nominal (categorical) data (i.e., gender, ethnicity, and grade level served). Furthermore the rho (ρ) correlation statistics was evaluated based upon Cohen's (1988) recommended interpretations of the relationships. The relationships were analyzed utilizing *all* of the items from the instruments and *not* the modified version from the SEM analysis. The Cronbach's alphas for the SCARS were presented earlier in this chapter. The analyses were organized into three categories: (a) Participants Characteristics, (b) Setting Characteristics, and (c) Other Demographic Information.

The relationships between the school counselors' characteristics and frequency of programmatic service delivery are presented in Table 42. The counselors' characteristics of gender, highest degree earned, and training program CACREP status did *not* identify any statistically significant correlations, indicating that these topics do *not* relate to respondents frequency of programmatic service delivery for this data. Age had a statistically significant relationship with Counseling ($\rho = .101, p < .05, 1.0\%$ of the variance explained), and consultation ($\rho = .085, p < .001, 0.7\%$ of the variance explained) but *not* the SCARS total score, curriculum, coordination and other activities. Ethnicity had a statistically significant relationship with total SCARS score ($\rho = -.116, p < .01, 1.3\%$ of the variance explained), counseling ($\rho = -.126, p < .01, 1.5\%$ of the variance explained), coordination ($\rho = -.097, p < .05, 0.9\%$ of the variance explained),

and other activities ($\rho = -.110, p < .01$; 1.2% of the variance explained) but *not* consultation and curriculum. Years as a school counselor has a statistically significant relationship with the SCARS total score ($\rho = .084, p < .05$; .07% of the variance explained), consultation ($\rho = .122, p < .01$; 1.5% of the variance explained) but *not* counseling, curriculum, coordination, and other activities. Years as a teacher had a statically significant relationship with other activities ($\rho = .130, p < .01$; 1.7% of the variance explained) but *no* other service delivery variables.

Table 42 *Spearman Rank Order Correlations between Demographics Factors and Programmatic Service Delivery, Participant Characteristics*

	SCARS Total Score	Counsel Service Delivery	Consultat Service Delivery	Curricu Service Delivery	Coordina Service Delivery	Other Service Delivery
Gender	NS	NS	NS	NS	NS	NS
Age	NS	$\rho = .101$ $p < .05$	$\rho = .085$ $p < .05$	NS	NS	NS
Ethnicity	$\rho = -.116$ $p < .01$	$\rho = -.126$ $p < .01$	NS	NS	$\rho = -.097$ $p < .05$	$\rho = -.110$ $p < .01$
Years as a SC	$\rho = .084$ $p < .05$	NS	$\rho = .122$ $p < .01$	NS	NS	NS
Years as a Teacher	NS	NS	NS	NS	NS	$\rho = .130$ $p < .01$
Highest Degree Earned	NS	NS	NS	NS	NS	NS
CACREP Graduate	NS	NS	NS	NS	NS	NS
ASCA Membership	$\rho = -.107$ $p < .05$	$\rho = -.196$ $p < .001$	NS	$\rho = -.084$ $p < .05$	$\rho = -.150$ $p < .001$	$\rho = .112$ $p < .01$

The relationships between school counselors' setting characteristics and their programmatic service delivery are presented in Table 43. The setting characteristic of school counseling program type (e.g., ASCA National Model) did *not* produce any statistically significant relationships, indicating that this topic does *not* relate to respondents service for these data. School type had a statistically significant relationship with consultation ($\rho = .089, p < .05$, 0.8% of the variance explained) but *not* with the other service delivery scales. School agency

type (e.g., public, private, or charter) had a statistically significant relationship with other activities ($\rho = -.167, p < .001, 2.8\%$ of the variance explained) but *not* with the other service deliver scales. Title I status had a statistically significant relationship with curriculum ($\rho = -.085, p < .05; 0.7\%$ of the variance explained) and other activities ($\rho = -.104, p < .05; 1.1\%$ of the variance explained) but *not* the other service deliver scales. School location had a statistically significant relationship with coordination ($\rho = -.129, p < .01; 1.7\%$ of the variance explained), but *not* the other service delivery scales. Grade levels served had a statistically significant relationship with the total SCARS score ($\rho = -.243, p < .001; 5.9\%$ of the variance explained), counseling ($\rho = -.192, p < .001; 3.7\%$ of the variance explained), consultation ($\rho = -.139, p < .001; 1.9\%$ of the variance explained), curriculum ($\rho = -.409, p < .01; 16.7\%$ of the variance explained), coordination ($\rho = -.092, p < .05; 0.8\%$ of the variance explained) but *not* other activities.

To further explore the relationship between the school counselors' grade level served and their reported frequency of programmatic service delivery a Kruskal–Wallis test was conducted. Specifically, the Kruskal–Wallis analysis examined the total reported frequency of *all* the SCARS subscales except other activities (e.g., the analysis examined appropriate [as identified by ASCA] school counselor activities). The Kruskal–Wallis test was chosen because the analysis sought to compare the means of three groups (Grade Levels) with data that *not* normally distributed. The resulting analysis identified that there was a statistical difference ($\chi^2 [6] = 66.300; p < .001; N = 571; \eta^2 = .116$) in the distribution of ranked scores between respondents working in an elementary school ($M_{rank} = 355.83; n = 182$), middle school ($M_{rank} = 285.26; n = 163$), high school ($M_{rank} = 210.09; n = 149$), K-8th grade schools ($M_{rank} = 287.04; n = 14$), 6-12th grade schools ($M_{rank} = 231.26; n = 21$), and K-12th grade schools ($M_{rank} = 293.67; n = 42$). Thus,

participants who work in elementary settings reported the most programmatic service delivery with k-12 schools second highest then middle school, 6-12th grade school, and high school being the lowest.

Table 43 *Spearman Rank Order Correlations Between Demographics Factors and Programmatic Service Delivery, Setting Characteristics*

	SCARS Total Score	Counsel Service Delivery	Consultat Service Delivery	Curricu Service Delivery	Coordina Service Delivery	Other Service Delivery
PSC Program Type	NS	NS	NS	NS	NS	NS
School Type	NS	NS	$\rho = .089$ $p < .05$	NS	NS	NS
School Agency Type	NS	NS	NS	NS	NS	$\rho = -.167$ $p < .001$
Title I Status	NS	NS	NS	$\rho = -.085$ $p < .05$	NS	$\rho = -.104$ $p < .05$
School Location	NS	NS	NS	NS	$\rho = .129$ $p < .01$	NS
Grade Levels Served	$\rho = -.243$ $p < .001$	$\rho = -.192$ $p < .001$	$\rho = -.139$ $p < .001$	$\rho = -.409$ $p < .001$	$\rho = -.091$ $p < .05$	NS

The relationships between the school counselors' other demographic characteristics and programmatic service delivery are presented in Table 44. Principal school counselor relationship was found to have a statistically significant relationship with total SCARS score ($\rho = .255, p < .001, 6.5\%$ of the variance explained), counseling ($\rho = .203, p < .001, 4.1\%$ of the variance explained), consultation ($\rho = .191, p < .001, 3.6\%$ of the variance explained), curriculum ($\rho = -.170, p < .001, 2.9\%$ of the variance explained), and coordination ($\rho = .288, p < .001, 8.2\%$ of the variance explained), but *not* other activities. Work satisfaction was found to have a statistically significant relationship with total SCARS score ($\rho = .246, p < .001, 6.0\%$ of the variance explained), counseling ($\rho = .281, p < .001, 7.9\%$ of the variance explained), consultation ($\rho = .159, p < .001, 2.5\%$ of the variance explained), curriculum ($\rho = .188, p < .001, 3.5\%$ of the variance explained), and coordination ($\rho = .243, p < .001, 5.9\%$ of the variance explained) but *not*

other activities. Work stress was found to have a statistically significant relationship with total SCARS score ($\rho = -.084, p < .05$; 0.7% of the variance explained), curriculum ($\rho = -.088, p < .05$; 0.8% of the variance explained), and coordination ($\rho = -.121, p < .01$; 1.5% of the variance explained) but *not* counseling, consultation, and other activities. Perceived job control was found to have a statistically significant relationship with total SCARS score ($\rho = .283, p < .001$, 8.0% of the variance explained), counseling ($\rho = .283, p < .001$, 8.0% of the variance explained), consultation ($\rho = .167, p < .001$, 2.8% of the variance explained), curriculum ($\rho = .272, p < .001$; 7.4% of the variance explained), coordination ($\rho = .324, p < .001$; 10.5% of the variance explained), and other activities ($\rho = -.116, p < .05$; 1.3% of the variance explained).

To further explore the relationships between school counselors' reported principal relationship, work satisfaction, work stress, and perceived job control and programmatic service delivery MLR was conducted. All assumptions were met except for normality of the data. Therefore, the results should be interpreted with caution. The linear composite of the predictor variables (principal relationship, work satisfaction, work stress, and perceived job control) predicted approximately 15.3% ($r = .398$) of the variance in the school counselors' programmatic service delivery, $F(4, 566) = 26.493, p < .001$. Two of the predictor variables had statistically significant beta coefficients for the dependent variable of programmatic service delivery and two did *not*. Work satisfaction ($\beta = .071, p < .001$) and perceived job control ($\beta = .265, p < .001$) were the predictor variables with a statistically significant beta values. Principal counselor relationship ($\beta = .070, p = .114$) and work stress ($\beta = .000, p = .991$) were *not* statistically significant.

Table 44 Spearman Rank Order Correlations between Other Demographics Factors and Programmatic Service Delivery, Setting Characteristics

	SCARS Total Score	Counsel Service Delivery	Consultat Service Delivery	Curricu Service Delivery	Coordina Service Delivery	Other Service Delivery
Princip-Counsel Relationship Work Satisfaction Work Stress	$\rho = .255$ $p < .001$	$\rho = .203$ $p < .001$	$\rho = .191$ $p < .001$	$\rho = -.170$ $p < .001$	$\rho = .228$ $p < .001$	NS
Perceived Job Control	$\rho = .246$ $p < .001$	$\rho = .281$ $p < .001$	$\rho = .159$ $p < .001$	$\rho = .188$ $p < .001$	$\rho = .243$ $p < .001$	NS
	$\rho = -.084$ $p < .05$	NS	NS	$\rho = -.088$ $p < .05$	$\rho = -.121$ $p < .01$	NS
	$\rho = .283$ $p < .001$	$\rho = .286$ $p < .001$	$\rho = .167$ $p < .001$	$\rho = .272$ $p < .001$	$\rho = .324$ $p < .001$	$\rho = -.116$ $p < .01$

Exploratory Research Question Three

Is there a statistically significant relationship between practicing schools counselors' professional quality of life (as measured by the *ProQOLs* [Stamm, 2010]) and their demographic variables (e.g., age, gender, and ethnicity)?

The school counselors' report of professional quality of life was measured by the ProQOLs (Scarborough, 2005) and includes three subscales (e.g., Burnout, Compassion Satisfaction, and Secondary Traumatic Stress) and a total score. To investigate the relationship between demographic variables and the respondents' report of professional quality of life a Spearman Rank Order correlation was used. Prior to the analysis the data was examined to test for assumptions. The skewness and kurtosis of the data indicated univariate non-normality. The z_{skewness} value for the ProQOLs scales ranged from 2.42 to 5.67 and the z_{kurtosis} value ranged from .61 to 1.48. Therefore, the Spearman Rank Order correlation analysis was selected because it is a non-parametric (e.g., doesn't rely on a distribution) method to analyze relationships between two variables. In addition, the Spearman Rank Order Correlation is an appropriate analysis for nominal (categorical) data (i.e., gender, ethnicity, and grade level served). Further the rho (ρ) correlation statistics was evaluated based upon Cohen's (1988) recommended interpretations of

the relationships. The relationships were analyzed utilizing *all* of the ProQOLs items and *not* the modified version from the SEM analysis. The Cronbach's alphas for the ProQOLs were presented earlier in this chapter. The analyses were organized into three categories: (a) Participants Characteristics, (b) Setting Characteristics, and (c) Other Demographic Information.

The relationship between the school counselors' characteristics and their professional quality of life is presented in Table 45. The participant characteristics of ethnicity, years as a school counselor, highest degree earned, and training program CACREP status did *not* produce any statistically significant results, indicating that these topics do *not* relate to respondents report of professional quality of life for this data. Gender has a statistically significant relationship with ProQOLs total score ($\rho = -.111, p < .01$; 1.2% of the variance explained) and secondary traumatic stress ($\rho = -.083, p < .05$; 0.7% of the variance explained) but *not* burnout and compassion satisfaction. Age had a statistically significant relationship with burnout ($\rho = -.152, p < .001$; 2.3% of the variance explained) and compassion satisfaction ($\rho = .142, p < .01$; 2.0% of the variance explained) but *not* ProQol total score and secondary traumatic stress. Years as a teacher had a statistically significant relationships with secondary traumatic stress ($\rho = .090, p < .05$; 0.8% of the variance explained) but *not* ProQOLs total score, burnout or compassion satisfaction. ASCA membership status had a statistically significant relationship with burnout ($\rho = .101, p < .05$; 1.0% of the variance explained), compassion satisfaction ($\rho = -.147, p < .001$; 2.2% of the variance explained), and secondary traumatic stress ($\rho = .118, p < .01$; 1.4% of the variance explained) but *not* ProQOLs total score.

To further explore the relationship between ASCA membership status and reported professional quality of life a Mann-Whitney U Test was conducted. The Mann-Whitney test was chosen because the analysis sought to compare the means of two groups (ASCA Membership

Status; yes or *no*) with data that *not* normally distributed and ordinal (e.g., 1-5 Likert Scaling). The Mann-Whitney test was conducted for burnout, compassion satisfaction, and secondary traumatic stress. Concerning burnout, the resulting analysis identified that there was a statistical difference ($U = 29647.50$; $Z = -2.40$; $p = .016$; $N = 574$; $r = .100$) in the distribution of score rankings between respondents holding membership in ASCA ($M_{rank} = 276.84$; $n = 407$) and respondents *not* currently holding membership in ASCA ($M_{rank} = 313.47$; $n = 167$), indicating that counselors who were members of ASCA report lower levels of burnout. Concerning compassion satisfaction, the resulting analysis identified that there was a statistical difference ($U = 27629.50$; $Z = -3.52$; $p < .001$; $N = 574$; $r = .147$) in the distribution of score rankings between respondents holding membership in ASCA ($M_{rank} = 303.11$; $n = 407$) and respondents *not* currently holding membership in ASCA ($M_{rank} = 249.45$; $n = 167$), indicating that counselors who were members of ASCA report higher levels of compassion satisfaction. Concerning secondary traumatic stress, the resulting analysis identified that there was a statistical difference ($U = 28905.50$; $Z = -2.822$; $p = .005$; $N = 574$; $r = .118$) in the distribution of score rankings between respondents holding membership in ASCA ($M_{rank} = 275.02$; $n = 407$) and counselors *not* currently holding membership in ASCA ($M_{rank} = 317.91$; $n = 167$), indicating that counselors who are members of ASCA report lower levels of secondary traumatic stress.

Table 45 Spearman Rank Order Correlations between Demographics Factors and Professional Quality of Life, Participant Characteristics

	ProQOLs Total Score	Burnout	Compassion Satisfaction	Secondary Traumatic Str.
Gender	$\rho = -.111$ $p < .01$	NS	NS	$\rho = -.083$ $p < .05$
Age	NS	$\rho = -.152$ $p < .001$	$\rho = .142$ $p < .01$	NS
Ethnicity	NS	NS	NS	NS
Years as a SC	NS	NS	NS	NS
Years as a Teacher	NS	NS	NS	$\rho = .090$ $p < .05$
Highest Degree Earned	NS	NS	NS	NS
CACREP Graduate	NS	NS	NS	NS
ASCA Membership	NS	$\rho = .101$ $p < .05$	$\rho = -.147$ $p < .001$	$\rho = .118$ $p < .01$

The relationships between the school counselors' setting characteristics and their professional quality of life scores are presented in Table 46. The setting characteristics of school counseling program type, school type, school agency type, Title I status, and grade levels served did *not* produce any statistically significant relationships, indicating that these topics do *not* relate to respondents report of professional quality of life for this data. However, school location had a statistically significant relationship with burnout ($\rho = .134, p < .01$; 1.8% of the variance explained) and compassion satisfaction ($\rho = -.189, p < .01$; 3.6% of the variance explained) but *not* ProQOLs total score and secondary traumatic stress.

Table 46 *Spearman Rank Order Correlations between Demographics Factors and Professional Quality of Life, Setting Characteristics*

	ProQOLs Total Score	Burnout	Compassion Satisfaction	Secondary Traumatic Str.
PSC Program Type	NS	NS	NS	NS
School Type	NS	NS	NS	NS
School Agency Type	NS	NS	NS	NS
Title I Status	NS	NS	NS	NS
School Location	NS	$\rho = .134$ $p < .01$	$\rho = -.112$ $p < .01$	NS
Grade Levels Served	NS	NS	NS	NS

The relationships between the school counselors' other demographic characteristics and their professional quality of life scores are presented in Table 47. Principal school counselor relationship was found to have a statistically significant relationship with ProQOLs total score ($\rho = -.150, p < .001, 22.5\%$ of the variance explained), burnout ($\rho = -.373, p < .001, 13.9\%$ of the variance explained), compassion satisfaction ($\rho = .370, p < .001; 13.7\%$ of the variance explained), and secondary traumatic stress ($\rho = -.178, p < .001; 3.2\%$ of the variance explained). Work satisfaction was found to have a statistically significant relationship with burnout ($\rho = -.373, p < .001, 13.9\%$ of the variance explained), compassion satisfaction ($\rho = .370, p < .001; 13.7\%$ of the variance explained), and secondary traumatic stress ($\rho = -.178, p < .001; 3.2\%$ of the variance explained) but *not* ProQOLs total score. Work stress was found to have a statistically significant relationship with ProQOLs total score ($\rho = .474, p < .001; 22.5\%$ of the variance explained), burnout ($\rho = .535, p < .001; 28.6\%$ of the variance explained), compassion satisfaction ($\rho = -.254, p < .001; 6.4\%$ of the variance explained), and secondary traumatic stress ($\rho = .418, p < .001; 17.5$ of the variance explained). Perceived job control was found to have a statistically significant relationship with ProQOLs total score ($\rho = -.160, p < .001; 2.6\%$ of the

variance explained), burnout ($\rho = -.408, p < .001, 16.6\%$ of the variance explained), compassion satisfaction ($\rho = .387, p < .001; 15.0\%$ of the variance explained), and secondary traumatic stress ($\rho = -.190, p < .001; 3.6\%$ of the variance explained).

To further explore the relationships between principal relationship, work satisfaction, work stress, and perceived job control and professional quality of life MLR was conducted. All assumptions were met except for normality of the data; therefore, the results should be interpreted with caution. The linear composite of the predictor variables (principal relationship, work satisfaction, work stress, and perceived job control) predicted approximately 23.2% ($r = .488$) of the variance in the school counselors' professional quality of life, $F(4, 566) = 43.84, p < .001$. One of the predictor variables had statistically significant beta coefficients for the dependent variable of programmatic service delivery and three did *not*. Work stress ($\beta = .463, p < .001$) was the only predictor variables with a statistically significant beta values. Principal counselor relationship ($\beta = -.075, p = .074$), work satisfaction ($\beta = .059, p = .151$), and perceived job control ($\beta = -.039, p = .349$) were *not* statistically significant.

Table 47 *Spearman Rank Order Correlations between Other Demographics Factors and Professional Quality of Life, Setting Characteristics*

	ProQOLs Total Score	Burnout	Compassion Satisfaction	Secondary Traumatic Str.
Princip-Counsel Relationship	$\rho = -.150$ $p < .001$	$\rho = -.373$ $p < .001$	$\rho = .370$ $p < .001$	$\rho = -.178$ $p < .001$
Work Satisfaction	NS	$\rho = -.498$ $p < .001$	$\rho = .634$ $p < .001$	$\rho = -.150$ $p < .001$
Work Stress	$\rho = .474$ $p < .001$	$\rho = .535$ $p < .001$	$\rho = -.254$ $p < .001$	$\rho = .418$ $p < .001$
Perceived Job Control	$\rho = -.160$ $p < .001$	$\rho = -.408$ $p < .001$	$\rho = .387$ $p < .001$	$\rho = -.190$ $p < .001$

Exploratory Research Question Four

Is there a statistically significant difference in practicing school counselors' total scores on the SCSEs (Bodenhorn & Skaggs, 2005), ProQOLs (Stamm, 2010), and SCARS (Scarborough, 2005) based upon the (a) sampling method (e.g., email web-based, paper-pencil mail-out survey, face-to-face survey administration), (b) token incentive type (e.g., monetary [\$1.00, \$2.00, or *no* incentive] or non-monetary [\$1.00 donation to the American Red Cross or *no* donation]), and (c) sampling population (e.g., ASCA dataset or Common Core Dataset)?

To examine mean differences in scores based upon (a) sampling method, (b) token incentive type, and (c) sampling population the total scores for the SCSEs (Bodenhorn & Skaggs, 2005), ProQOLs (Stamm, 2010), and SCARS (Scarborough, 2005) were consulted. Prior to the analysis the data was examined to test for assumptions. The skewness and kurtosis of the data indicated univariate non-normality. Also, the data collected was ordinal (e.g., 1-5 Likert Scaling). Therefore, the Mann-Whitney U test and the Kruskal-Wallis H test were utilized to compare the distribution of rankings (Pallant, 2010). The relationships were analyzed utilizing *all* of the items from the instruments and *not* the modified version from the SEM analysis. Additionally, the entire dataset ($N = 735$) was used, which included the outliers that were screened for in the aforementioned analysis. The inclusion of the outliers allows the analysis to examine the characteristics of the entire dataset. The Cronbach's alphas for the instruments were discussed earlier in this chapter. The analyses were organized into three categories: (a) sampling method, (b) incentive type, and (c) sampling population.

Sampling Method. The Kruskal–Wallis test was chosen because the analysis sought to compare the total scale scores on the SCSEs, SCARS, and ProQOL for three

groups (*Sampling methods*: Paper Pencil Mailing, Email/Internet, and Face to Face) with data that is *not* normally distributed. The Kruskal-Wallis analysis identified a statistically significant difference in the distribution of ranks for total ProQOLs score among the groups of sampling methodologies ($\chi^2 [2] = 18.55; p < .001; N = 698; \eta^2 = .027$). The results indicated that face-to-face administration ($M_{rank} = 398.18; n = 216$) produces higher scores as compared to Paper-Pencil Mail Out ($M_{rank} = 331.71; n = 287$) and Email-Internet ($M_{rank} = 321.75; n = 195$) data collection methods. A Mann-Whitney test was conducted to further analyze the differences. The resulting Mann-Whitney analysis identified that there was *not* a statistical difference ($U = 27076; Z = -.605; p = .545; N = 482; r = .027$) in the distribution of score rankings of ProQOLs total scores between those collected by Paper-Pencil Mail ($M_{rank} = 244.66; n = 287$) and Email Internet ($M_{rank} = 236.85; n = 195$). However, there was a statistical difference ($U = 24985; Z = -3.729; p < .001; N = 503; r = .166$) in the distribution of score rankings of ProQOLs total scores between those collected by Paper-Pencil Mail ($M_{rank} = 231.06; n = 287$) and Face to Face ($M_{rank} = 279.83; n = 216$). Also, there was a statistical difference ($U = 16556; Z = -3.749; p < .001; N = 411; r = .185$) in the distribution of score rankings of ProQOLs total scores between those collected by Email Internet ($M_{rank} = 182.90; n = 195$) and Face-to-Face ($M_{rank} = 226.85; n = 216$). Therefore, the school counselors had higher total scores on their ProQOLs if they completed it in the Face-to-Face administration as compared to if they completed it by Email Internet or Paper Mail.

Sampling methods were also investigated by examining the difference in SCSEs total score based upon sampling method. The Kruskal-Wallis analysis identified a statistically significant difference in the distribution of ranks for total SCSEs score among

the groups of sampling methodologies ($\chi^2 [2] = 22.27; p < .001; N = 710; \eta^2 = .031$). The results indicated that email/internet administration ($M_{rank} = 404.57; n = 207$) produced higher scores as compared to Paper-Pencil Mail Out ($M_{rank} = 353.75; n = 290$) and Face-to-Face ($M_{rank} = 310.19; n = 213$) data collection methods. A Mann-Whitney test was conducted to further analyze the differences. The resulting Mann-Whitney analysis identified that there was a statistical difference ($U = 25569; Z = -2.817; p = .005; N = 497; r = .126$) in the distribution of score rankings of SCSEs total scores between those collected by Paper-Pencil Mail ($M_{rank} = 233.67; n = 290$) and Email Internet ($M_{rank} = 270.48; n = 207$). Also, there was a statistical difference ($U = 26947; Z = -2.445; p = .014; N = 503; r = .109$) in the distribution of score rankings of ProQOLs total scores between those collected by Paper-Pencil Mail ($M_{rank} = 265.58; n = 290$) and Face-to-Face ($M_{rank} = 233.51; n = 213$). In addition, there was a statistical difference ($U = 16332.50; Z = -4.594; p < .001; N = 420; r = .224$) in the distribution of score rankings of SCSEs total scores between those collected by Email Internet ($M_{rank} = 238.10; n = 207$) and Face-to-Face ($M_{rank} = 183.68; n = 213$). Therefore, the school counselors scored higher on the SCSEs if they completed it online as compared to completing it by Face-to Face or mail administrations.

Sampling methods were additionally investigated by examining the difference in SCARS total score based upon sampling method. The Kruskal-Wallis analysis did *not* identify a statistically significant difference in the distribution of ranks for total SCARS score among the groups of sampling methodologies ($\chi^2 [2] = 1.095; p = .579; N = 713; \eta^2 = .001$). In consideration of the results from the SEM mode, the researcher conducted a follow-up analysis by removing the subscale for Other Activities. The Other Activities

Subscale did *not* contribute in the SEM model and therefore may be confounding the Kruskal-Wallis. The Kruskal-Wallis with the modified total score of the SCARS identified a statistically significant difference in the distribution of ranks for total SCARS score (without the Other Activities Items) among the groups of sampling methodologies ($\chi^2 [2] = 18.58; p = .014; N = 713; \eta^2 = .026$). The results indicated that email/internet administration ($M_{rank} = 384.46; n = 208$) produces higher scores as compared to Paper-Pencil Mail Out ($M_{rank} = 360.15; n = 290$) and Face-to-Face ($M_{rank} = 326.18; n = 215$) data collection methods.

A Mann-Whitney test was conducted to further analyze the difference SCARS total score (with Other Activities Subscale removed) based upon sampling method. The resulting Mann-Whitney analysis identified that there was *not* a statistical difference ($U = 28096; Z = -1.30; p = .193; N = 498; r = .058$) in the distribution of score rankings of SCARS total scores between those collected by Paper-Pencil Mail ($M_{rank} = 242.38; n = 290$) and Email Internet ($M_{rank} = 259.42; n = 208$). Furthermore, there was *not* a statistical difference ($U = 281197; Z = -1.837; p = .066; N = 505; r = .082$) in the distribution of score rankings of SCARS total scores between those collected by Paper-Pencil Mail ($M_{rank} = 263.27; n = 290$) and Face-to-Face ($M_{rank} = 238.15; n = 215$). However, there was a statistical difference ($U = 18712; Z = -2.902; p = .004; N = 423; r = .141$) in the distribution of score rankings of SCARS total scores between those collected by Email Internet ($M_{rank} = 229.54; n = 208$) and Face-to-Face ($M_{rank} = 195.03; n = 215$). Therefore, the school counselors scored higher on the SCARS if they complete it online as compared to completing it by Face-to-Face.

Incentive type. Incentive type was investigated in two ways. First, the Paper/Pencil Mail Out respondents either received *no* incentive, a \$1 incentive, or a \$2 dollar incentive. Second, the email/internet participants received either *no* incentive or a non-monetary (\$1 donation to the American Red Cross). To analyze the difference in incentive types, a comparison of the total scale scores on the ProQOLs, SCSEs, and SCARS was facilitated using the Kruskal Wallis H test and Mann-Whitney U-test. The Kruskal Wallis H test and Mann-Whitney U-Test were selected because the data is *not* normally distributed and consist of Ordinal data points (e.g., 1-5 Likert Scaling). The analyses were organized into two categories: (a) Paper Mail Out Incentives (e.g., \$0, \$1, or \$2) and (b) Email Internet Incentives (e.g., \$0 or a \$1 donation to the American Red Cross).

Paper mail out incentives. Incentive types were investigated by examining the mean difference in ProQOLs, SCARS, and SCSEs total scores for the paper mail out respondents using the Kruskal-Wallis analysis. The Kruskal-Wallis analysis did *not* identify a statistically significant difference in the distribution of ranks for total ProQOLs score among the groups of incentive types ($\chi^2 [2] = 3.741; p = .154; N = 287; \eta^2 = .013$). In addition, the Kruskal-Wallis analysis did *not* identify a statistically significant difference in the distribution of ranks for total SCARS score among the groups of incentive types ($\chi^2 [2] = 1.426; p = .490; N = 290; \eta^2 = .005$). However, the Kruskal-Wallis analysis did identify a statistically significant difference in the distribution of ranks for total SCSEs score among the groups of incentive types ($\chi^2 [2] = 10.212; p = .006; N = 290; \eta^2 = .035$). The results indicated that the \$2 incentive ($M_{rank} = 166.05; n =$

106) produced higher scores on the SCSEs as compared to the \$1 incentive ($M_{rank} = 135.86; n = 108$) and *no* incentive ($M_{rank} = 130.55; n = 76$) data collection methods.

A Mann-Whitney test was conducted to further analyze the different SCSEs total score based upon incentive type. The resulting Mann-Whitney analysis identified that there was *not* a statistical difference ($U = 3961.5; Z = -.401; p = .689; N = 184; r = .018$) in the distribution of score rankings of SCSEs total scores between those Mail/Paper based respondents who received *no* incentive ($M_{rank} = 90.63; n = 76$) and a \$1 incentive ($M_{rank} = 259.42; n = 208$). However, the Mann-Whitney analysis identified that there was a statistical difference ($U = 4540; Z = -2.615; p = .009; N = 214; r = .179$) in the distribution of score rankings of SCSEs total scores between those Mail/Paper based respondents who received the \$1 incentive ($M_{rank} = 96.54; n = 108$) and the \$2 incentive ($M_{rank} = 118.67; n = 106$). Also, the Mann-Whitney analysis identified that there was a statistical difference ($U = 3034; Z = -2.836; p = .005; N = 182; r = .210$) in the distribution of score rankings of SCSEs total scores between those Mail/Paper based respondents who received *no* incentive ($M_{rank} = 78.42; n = 76$) and the \$2 incentive ($M_{rank} = 100.88; n = 106$). The results of the Kruskal-Wallis and Mann-Whitney tests indicated that there was a mean difference in the school counselors' SCSEs score based upon the incentive type with larger amounts of incentive giving higher scores on the SCSEs; however, no mean differences were identified in the ProQOLs and SCARS scores with these data.

Email Internet incentive. Incentive types (e.g., *no* incentive or non-monetary donation of \$1 to American Red Cross) were investigated by examining the difference in ProQOLs, SCARS, and SCSEs total scores for the email/internet respondents using the

Mann-Whitney analysis. The Mann-Whitney analyses identified that there was *not* a statistical difference ($U = 4184.5$; $Z = -1.442$; $p = .149$; $N = 195$; $r = .103$) in the distribution of score rankings of ProQOLs total scores between those email/internet based respondents who received *no* incentive ($M_{rank} = 103.73$; $n = 99$) and the \$1 donation ($M_{rank} = 92.09$; $n = 96$). Furthermore, the Mann-Whitney analyses identified that there was *not* a statistical difference ($U = 4828.5$; $Z = -1.432$; $p = .152$; $N = 209$; $r = .099$) in the distribution of score rankings of SCARS total scores between those email/internet based respondents who received *no* incentive ($M_{rank} = 99.21$; $n = 108$) and the \$1 donation ($M_{rank} = 111.19$; $n = 101$). In addition, the Mann-Whitney analyses identified that there was *not* a statistical difference ($U = 4606.5$; $Z = -1.846$; $p = .065$; $N = 208$; $r = .128$) in the distribution of score rankings of SCSEs total scores between those email/internet based respondents who received *no* incentive ($M_{rank} = 96.87$; $n = 105$) and the \$1 donation ($M_{rank} = 112.28$; $n = 103$). The results indicated that incentive type did *not* influence the school counselors' response for the email/internet respondents with these data.

Sampling Population. The sampling population was investigated for the paper mail sampling groups. Participants for the paper mail group were either selected from the ASCA database (e.g., population of ASCA Members) of the Common core database (e.g., population of *all* school counselors). The Mann-Whitney U test was chosen because the analysis sought to compare the total scale scores for two groups of sampled populations for the Paper Mail survey with data that is *not* normally distributed and ordinal (e.g., 1-5 Likert Scaling). The Mann-Whitney U analysis identified that there was *not* a statistical difference ($U = 19353.5$; $Z = -.944$; $p = .345$; $N = 287$; $r = .056$) in the distribution of

score rankings of ProQOLs total scores between those mail paper based respondents who were sampled from the Common Core Dataset ($M_{rank} = 148.48$; $n = 148$) and ASCA Membership Dataset ($M_{rank} = 139.23$; $n = 139$). Moreover, the Mann-Whitney U analysis identified that there was *not* a statistical difference ($U = 20702$; $Z = -1.574$; $p = .116$; $N = 290$; $r = .092$) in the distribution of score rankings of SCSEs total scores between those mail paper based the counselors who were sampled from the Common Core Dataset ($M_{rank} = 138.01$; $n = 150$) and ASCA Membership Dataset ($M_{rank} = 153.52$; $n = 140$). However, the Mann-Whitney U analysis identified that there was a statistical difference ($U = 9019.5$; $Z = -2.076$; $p = .038$; $N = 290$; $r = .121$) in the distribution of score rankings of SCARS total scores between those mail paper based respondents who were sample from the Common Core Dataset ($M_{rank} = 135.63$; $n = 140$) and ASCA Membership Dataset ($M_{rank} = 156.08$; $n = 140$). Therefore, the results indicate that the school counselors sampled from the ASCA membership dataset reported higher frequency of service delivery than the common core dataset. Nevertheless, the sampling source did *not* influence the total scores on the SCSEs and the ProQOLs for these data.

Exploratory Research Question Five

Is there a statistically significant difference in practicing school counselors' response rate (as measured by completion of the SCSEs, Bodenhorn & Skaggs, 2005; ProQOLs, Stamm, 2010; and SCARS, Scarborough, 2005) based upon the (a) sampling method (e.g., email web-based, paper-pencil mail-out survey, face-to-face survey administration), (b) token incentive type (e.g., monetary [\$1.00, \$2.00, or *no* incentive] or non-monetary [\$1.00 donation to the American Red Cross or *no* donation]), and (c)

sampling population (e.g., ASCA Dataset, Common Core Dataset, ASCA Online Directory, or Face to Face)?

To examine the relationship between response rate and sampling method, incentive type, and sampling population a chi square test of independence was conducted. The chi square test of independence was chosen because the analysis seeks to examine the relationship between a categorical dependent variable (e.g., unit nonresponse) and a categorical independent variable (e.g., sampling method, incentive type, and sampling population). The data meets the assumption of chi square test of independence (e.g., random samples, independent observations, and lowest frequency is 5 or higher; Pallant, 2010). The data used for this analysis included the entire dataset without data cleaning because the goal was to examine the response rates for *all* respondents. The sample included *all* potential participants, whether they participated or *not*, which results in a sample size of 3,795. Any participant whose email or paper-mail was returned as a result of incorrect contact information was *not* included in the analysis, resulting in removing 41 cases. Table 48 provides a review of the response rate based on collection method, incentive type, and sampled population.

A chi square test of independence was conducted to evaluate whether unit nonresponse rate varies depending upon the method of data collection (e.g., Paper/Mail, Internet/Email, and Face to Face). Unit nonresponse was statistically significant in relationship to the data collection method, Pearson $\chi^2 (2, N = 3,795) = 1331.11, p < .001, \phi = .592$, identifying a moderate to large effect (Pallant, 2010). The proportion of respondents who did *not* complete the *all* instruments (e.g., unit nonresponse) when sampled through face to face administration (16.1%) was lower as compared to when participants were sampled by paper/email (51.5%) and email/internet (93.4%).

A chi square test of independence was conducted to evaluate whether unit nonresponse rate varies depending upon the type of incentive (e.g., *no* incentive, \$1 incentive, or \$2 incentive) used in paper/mail survey administration. Unit nonresponse was *not* statistically significant in relationship to the type of incentive used in paper/mail survey administration, Pearson χ^2 (2, $N = 592$) = 5.47, $p = .065$. Therefore, there was *no* statistically significant difference in response rate based upon the type of incentive the participants were offered in paper/mail survey administration. In addition, a chi square test of independence was conducted to evaluate whether unit nonresponse rate varies depending upon the type of incentive (e.g., *no* incentive or a \$1 donation to the American Red Cross) in email/internet survey administration. Unit nonresponse was *not* statistically significant in relationship to the type of incentive used in email/internet survey administration, Pearson χ^2 (1, $N = 2966$) = .037, $p = .847$. Thus, there was *no* statistically significant difference in response rate based upon the type of incentive the school counselors were offered in email/internet survey administration

A chi square test of independence was conducted to evaluate whether unit nonresponse rate varies depending upon the population sampled for the mail/paper survey administration (e.g., ASCA Dataset, Common Core Dataset, ASCA Online Directory, or Face to Face). Unit nonresponse was statistically significant in relationship to the population sampled, Pearson χ^2 (2, $N = 3,795$) = 1337.80, $p < .001$, phi = .594, identifying a moderate to large effect (Pallant, 2010). The proportion of respondents who did *not* complete the *all* instruments (e.g., unit nonresponse) when identified through face to face sampling (convenience sampling) was lower (16%) as compared to when participants were identified through the Common Core Dataset (50%), ASCA Dataset (53.1%), and ASCA Online Directory (93.4%).

Table 48 *Unit Nonresponse Rates*

		Unit Nonresponse <i>Cases never started or completed</i>
Collection Method		
	Paper/Mail (<i>N</i> = 592)	51.5% (<i>n</i> = 305)
	Internet/Email (<i>N</i> = 2,967)	93.4% (<i>n</i> = 2,771)
	Face to Face (<i>N</i> = 237)	16% (<i>n</i> = 38)
Incentive-Paper/Mail		
	No Incentive (<i>N</i> = 201)	58.2% (<i>n</i> = 117)
	\$1 Incentive (<i>N</i> = 197)	47.7% (<i>n</i> = 94)
	\$2 Incentive (<i>N</i> = 194)	48.5% (<i>n</i> = 94)
Incentive-Internet		
	No Incentive (<i>N</i> = 1,486)	93.3% (<i>n</i> = 1,387)
	\$1 Donation (<i>N</i> = 1,384)	93.5% (<i>n</i> = 1,384)
Sampled Population for Paper Mail		
Collection Method		
	ASCA Dataset (<i>N</i> = 294)	53.1% (<i>n</i> = 156)
	Common Core Dataset (<i>N</i> = 298)	50% (<i>n</i> = 149)
	ASCA Online Directory (<i>N</i> = 2,966)	93.4% (<i>n</i> = 2771)
	Face to Face Convenience Sample (<i>N</i> = 237)	16% (<i>n</i> = 38)

Chapter Four Summary

Chapter four presented the results for the investigation. The research hypothesis was analyzed using SEM. Furthermore, the exploratory research questions were analyzed using: (a) MLR (b) Spearman Rho correlation, (c) Mann-Whitney U test, (d) Kruskal-Wallis H test, and (e) Chi-Square test of independence. Chapter five discusses the findings and provides implications for practicing school counselors, counselor educators, and potential future research directions

CHAPTER FIVE: DISCUSSION

Chapter five provides a review of the study, research methodology utilized, and discussion of the results from the investigation. In addition, chapter five describes the results from chapter four and compares them to previous research reviewed in chapter two. The findings regarding the research question and exploratory questions are examined and implications are discussed. Furthermore, chapter five: (a) presents the limitations of the study, (b) discusses future research directions, and (c) offers implications for practice.

Introduction and Statement of the Problem

The practice of school counseling requires the management of many tasks (American School Counselor Association [ASCA], 2012). However, the goal for school counselors is to support the academic, personal/social, and career success of students through the dismantling of barrier that may prohibit their ability to lead responsible lives (Gysbers, 2010; Schmidt, 2008). School counselors undergo experiences that contribute to burnout and fatigue (Butler & Constantine, 2005; Lambie, 2007; Limberg, 2013; Moyer, 2011; Wilkerson, 2009; Wilkerson & Belinki, 2006). Furthermore, school counselors' self-efficacy is an important construct in relation to their work on the job (Bodenhorn & Luke, 2008; Bodenhorn & Skaggs, 2005; Bodenhorn, Wolfe, & Airen, 2010; Clark, 2006; Sutton & Fall, 1995). Both school counselor wellbeing and self-efficacy have been identified as constructs that relate to programmatic service delivery (e.g., Baggerly & Osborne, 2006; Clark, 2006; Woods, 2009); however, there is *no* research that examined the interplay of these constructs. In addition, no prior research examines the construct of professional quality of life (Stamm, 2010) in relation to school counselor self-efficacy and programmatic service delivery. Therefore, this study explored the directional relationships

between professional quality of life, self-efficacy, and programmatic service delivery in a sample of practicing school counselors.

Another purpose of this study was to examine survey research methodology for collecting data with practicing school counselors. The methodology used in research is guided by the questions that are being asked (Gall, Gall, & Borg, 2007). Survey research involves the collection of information pertaining to a respondent's knowledge, feelings, beliefs, values, behaviors, and states of mind (Fink, 2006). As such, the act of collecting survey research is complex (Dillman, Smyth, & Christenson, 2009), which necessitates that research is conducted to examine best practices. Some research exists on survey methodology (e.g., Cole, 2005; Kwak & Radler, 2002; Leece et al., 2004; Wolfe, Converse, & Oswald, 2008) but there is limited literature for collecting data with practicing school counselors (e.g., Wolfe, Converse, Airen, & Bodenhorn, 2009). Therefore, this study investigated the difference in response rate and mean total scores of the data collection instruments with the goal to identify effective survey methodology to supplant existing literature on the data collection with school counselors.

Review of the Methodology

The following section provides a brief review of the research methodology used in this study. For a detailed description of the methodology, please consult chapter three. This study utilized a nonexperimental descriptive, correlational research design (Gall et al., 2007) to examine the research hypothesis and exploratory questions. The primary research question of this investigation sought to examine a hypothesized directional relationship between professional quality of life, self-efficacy, and programmatic service delivery without any form of manipulation; therefore, the design was correlational (Fraenkel & Wallen, 2009). Furthermore, the study was descriptive in nature because it described the relationship between the variables in

a single sample (Gall et al., 2007). The study observed respondents as they naturally occur in their environment and thus was non-experimental (Gall et al., 2007). Prior to any data collection, the researcher received approval from the Institutional Review Board at the University of Central Florida (see appendix A).

Population and Sample

This study sought a minimum randomly selected sample size of 384 practicing school counselors based on a 95% confidence interval with the population of the sample consisting of 105,078 school counselors in the United States (U.S.). Moreover, the minimum sample size requirement based on the statistical analysis and power was 400 (MacCallum et al., 1996; Schumacher & Lomax, 2010). The sampling procedures involved both convenient and simple random sampling. The convenience sampling consisted of two school districts within the U.S., of which the researcher identified, contacted and requested permission from each school district to invite practicing school counselors to participate in this study. The researcher attended professional development meetings for these districts and offered the survey at a time that was convenient for the respondents. The school districts were identified based on geographical, contextual, and socioeconomic diversity. Ten school districts were contacted and two districts accepted the offer to participate in the investigation.

The simple random samples were derived from two sources: (a) the ASCA membership database and (b) the Common Core dataset. The ASCA membership data was purchased from ASCA for \$250.00 and provided 2,000 potential participants who were randomly selected from the total ASCA membership pool. Furthermore, the ASCA membership database consisted of selected geographically diverse ASCA members who were practicing school counselors at the

Elementary, Middle, and High School levels. From the ASCA list, 300 participants were randomly selected using Microsoft Excel.

The Common Core dataset is a publicly available listing (cf. www.nces.ed.gov/ccd) maintained by the Federal Department of Education. The Common Core dataset provides the listings and demographic information for every school, public or private, in the United States. Three hundred schools from the entire population of school in the U.S. were randomly identified from the Common Core dataset using Microsoft Excel. Then, the researcher randomly identified a school counselor at each school to be the potential participant, also using Microsoft Excel.

The researcher accessed the ASCA online membership directory and randomly retrieved 3,000 members. The ASCA membership directory is available for members on the ASCA website (cf. schoolcounselor.org). However, the ASCA online directory doesn't allow for filtering of membership type (e.g., school counselor, counselor educator, and student). Thus, the researcher screened this sample by including a verification question in the beginning of the survey. If any of these participants indicated they were *not* a practicing school counselor, they were redirected from the survey site and did *not* complete it. The total sample size was 3,800 with the goal of obtaining a useable sample size of 400.

Data Collection

This study utilized multiple methods for collecting data, including: (a) paper/mail surveying, (b) email/internet surveying, and (c) face-to-face surveying. The paper/mail survey followed the *Tailored Design Method* (Dillman et al., 2009) and included four contacts. Additionally, participants who were invited by paper/mail were offered the opportunity to complete the survey by returning the mailed survey or by completing it online. Mail/paper survey participants ($N = 600$) were randomly assigned to incentive groups of: (a) no incentive,

(b) \$1 incentive, or (c) \$2 incentive. The mail/paper survey group included the ASCA Membership dataset and Common Core dataset as its sample.

The email/internet survey participants ($N = 3,000$) were invited to take an online survey (www.qualtrics.com) and were contacted by email. The email invitations were developed based on *Tailored Design Methods* (Dillman et al., 2009) and included three contacts. Participants in the email/internet survey were assigned to either: (a) no incentive or (b) \$1 donation to the American Red Cross (nonmonetary incentive). The sample for the email/internet survey administration was the ASCA online directory listing.

The final survey method used involved a face-to-face administration of the survey at two school districts' professional development meeting with their school counselors (a priori estimated $N = 200$). Participants in face-to-face administration group were invited to participate by the researcher. If the school counselor chose to participate in the investigation, they completed the survey in paper format and then placed it in a sealed envelope. No incentives were used for this sample of participants. All completed surveys were returned to the researcher. In all survey methods, any identifiable information was removed to make the respondents participation anonymous.

Instrumentation

This study utilized three instruments and a demographics questionnaire. The ProQOLs (Stamm, 2010) is a 30-item instrument used to measure participants' professional quality of life based on Likert (1 to 5) scaling. The ProQOLs includes three subscales that measure: (a) burnout (10 items), (c) secondary traumatic stress (10 items), and (c) compassion satisfaction (10 items). The SCSEs (Bodenhorn & Skaggs, 2005) is a 43-item instrument that assesses school counselor self-efficacy based on Likert (1 to 5) scaling. The SCSEs consists of five subscales, including:

(a) personal and social development (12 items), (b) leadership and assessment (nine items), (c) career and assessment (seven items), (d) collaboration (11 items), and (e) cultural awareness (four items). The SCARS (Scarborough, 2005) is a 48-item instrument used to measure the frequency that the respondent completes school counseling related activities, which is based on Likert (1 to 5) scaling. The SCARS consists of five subscales, including (a) counseling (10 items), (b) consultation (7 items), (c) coordination (13 items), (d) curriculum (8 items), and (e) other activities (10 items).

The general demographics questionnaire requests the following information from participants: (a) ethnicity/race; (b) age, (c) gender, (d) current school level (e.g., elementary school, middle/junior high school, and high school), (e) years of experience as a teacher prior to the current year (zero indicates no teaching experience), (f) years of experience as a school counselor prior to current year (zero indicate it is their first year as a school counselor), (g) school location (e.g., rural, urban, suburban), (h) type of school setting (e.g., regular school [private or public], career center, special education center, alternative education), (i) degree level (e.g., masters, educational specialist, or doctorate), (j) graduate program CACREP status, (k), current professional membership status, and (l) open comment box. In addition, 12 Likert scaling items that measured four domains (e.g., Principal-Counselor Relationship, Job Satisfaction, Job Stress, and Perceived Job Control) were used.

Data Analysis

To test the research hypothesis and answer the exploratory research questions multiple data analysis were used. The research hypothesis was analyzed using *Structural Equation Modeling* (SEM). The exploratory research questions were analyzed using: (a) Multiple Linear Regression (MLR), (b) Spearman Rho correlation, (c) Mann-Whitney U test, (d) Kruskal-Wallis

H test, and (e) Chi-Square test of independence. Effect sizes were calculated for the Mann-Whitney U Tests and Kruskal-Wallis tests by using post-hoc analysis (Mann-Whitney: $r = Z/\sqrt{N}$; Kruskal-Wallis: $\eta^2 = \chi^2/(N-1)$).

Data Screening and Statistical Assumptions for SEM

An important step in quantitative research is screening the data and checking for statistical assumptions (Hair et al., 2006). The data was screened for the SEM and MLR, which includes the following assumption: (a) adequate sample size, (b) consideration of missing data, (c) outliers, (d) univariate and multivariate normality, (e) multicollinearity and singularity, (f) linearity of variables and homoscedasticity. All assumptions were met except for the presence of extreme outliers and normality. The outliers were examined and removed using univariate, bivariate, and multivariate techniques for identification, resulting in the elimination of 113 items and produced a sample size of 577. However, the outlier free sample was only used for the SEM and MLR. Consequently, the other analyses were calculated using the sample that included the outlier ($N = 690$) because the outliers were less volatile and the sample was larger (Pallant, 2010). Furthermore, the demographic characteristics of the sample were described using the sample that included the outliers ($N = 690$).

Summary of the Results

The summary of results section presents and describes the findings from this investigation. Specifically, the summary of results section includes a review of the results of the: (a) descriptive data, (b) primary research hypothesis, and (c) exploratory research questions.

Descriptive Data Results

Participant Response Rate

This investigation utilized diverse methods for data collection. Specifically, this study employed: (a) paper/mail surveying, (b) email/internet surveying, and (c) face-to-face surveying. Overall, 3,836 participants were invited to participate in this study; however, 42 of the participants either were *not* practicing school counselors or were no longer working as a school counselor at the time of the survey. Therefore, the number of potential respondents after removing the individual who no longer qualified for the study was 3,794. Of the remaining 3,794, a total response rate, including packets that were partially completed, was 22.43% ($N = 851$). Upon closer inspection, some packets were incomplete. The resulting response rate for the packets that were complete was 18.18% ($N = 690$). Table 49 provides a detailed breakdown of the response rates by sample and data collection method.

Table 49 *Sampling and Data Collection Methodology*

Data Category	Total (<i>n</i>)	Response Rate
Sample Group ($N = 690$)		
ASCA Membership List	139	46.6%
Common Core Data List	148	50.3%
ASCA Online Directory	195	6.5%
Identified School Districts (two)	208	88.1%
Data Collection Method ($N = 690$)		
Paper-Pencil Mail Out	287	41.6%
Email/Web-Based	195	6.5%
Face-to-Face	208	88.1%

The response rate for this investigation was similar to other studies that used similar data collection and sampling methods (e.g., Baggerly & Osborne, 2006; Butler & Constantine, 2005; Lambie, 2007; Limberg, 2013). Specifically, it is typical to have a 40-55% response rate for mail/paper survey administrations with school counselors (e.g., Bryan & Griffith, 2010; Butler & Constantine, 2003; Lambie, 2007; Wilkerson & Bellini, 2006; Wilkerson, 2009). In addition, the

use of email/internet surveys with school counselors typically returns a response rate of 10-15% (e.g., Harris, 2013; Limberg, 2013; Mullen, Lambie, & Conley, 2014); however, the response rate for this study was slightly lower (6.5%) than other studies. The length of the instrument packet (e.g., 127 items to be completed) may have caused respondent attrition (Gall et al., 2007), which produced a lower response rate when compared to other studies using a similar method and smaller instrument packets. Furthermore, face-to-face survey administrations with school counselors traditionally return 80-100% response rate (e.g., Ieva, 2010; Lambie, Ieva, Mullen, & Hayes, 2011), which is similar to the response rate for face-to-face administration in this study. Overall, the response rates for this study were consistent with similar data collection methodology with practicing school counselors (e.g., Bryan & Griffith, 2010; Harris, 2013; Ieva, 2010; Lambie et al., 2011; Mullen et al., 2014; Wilkerson, 2009).

Participant Characteristics

This study was composed of practicing school counselors ($N = 690$) from across the United States. Participants who indicated they were *not* practicing school counselors were identified and removed from the study. Results from the descriptive analysis revealed that participants ($N = 688$) consisted of 545 (79.0%) females, 143 (20.7%) males with two participants *not* responding. The reported average age of respondents ($N = 679$) was 43.2 years ($SD = 11.18$, Range = 24 to 74, $Mdn = 42$, Mode = 34). The reported ethnicity of the participants ($N = 686$) was 407 (68.7%) White, 107 (15.5%) African-Americans, 70 (10.1%) Other Ethnicity, 15 (2.2%) Hispanic, 12 (1.7%) Multiracial, 6 (0.9%) Native-Americans, 1 (0.1%) Asian American, and 1 (0.1%) Pacific/Islander with 4 (0.5%) respondents *not* reporting ethnicity.

When asked about their school counseling preparation, participants' ($N = 684$) reported that their highest degree earned was 548 (79.6%) earned a Master's Degree, 91 (13.2%) earned

an Educational Specialist Degree, 14 (2.0%) Doctorate of Education Degree, 14 (2.0%) earned a Doctorates of Philosophy Degree, and 2 (0.3%) earned a Bachelor's Degree, with 6 respondents *not* reporting highest earned degree. Furthermore, of the reporting participants ($N = 684$), 451 reported attend a CACREP accredited program for their counselor preparation, 95 (13.8%) did *not* attend a CACREP program for their school counselor preparation, and 137 (19.9) indicated they did *not* know if they attend a CACREP program for their counseling preparation, with 4 (0.5%) participants *not* responding. In regards to professional experiences, respondents average number of *years of experience as a school counselor* ($N = 689$) was 10.38 years ($SD = 7.59$, Range = 0 to 39, $Mdn = 8$, Mode = 7), with 17 (2.4%) participants in their first year as a school counselor. The average number of *years of experience as a teacher* of respondents ($N = 691$) was 4.73 years ($SD = 6.95$, Range = 0 to 42, $Mdn = 1$, Mode = 0), with 314 (45.5%) participants having never worked as a teacher.

Additional descriptive data analysis identified that 469 (68.4%) of respondents ($N = 686$) were members of ASCA at the time of completing the data collection instruments with 217 (31.6%) *not* being members of ASCA, and 4 (0.5%) *not* reporting their membership status. Furthermore, within the subgroup of participants who were *not* a member of ASCA at the time of the data collection ($N = 217$), 92 (42.4%) were a member of ASCA in the previous five years and 125 (57.6%) were *not* a member of ASCA in the previous five years. Additionally, of the subgroup of participants who were *not* a member of ASCA at the time of the data collection ($N = 217$), 81 (38.2%) reported that membership cost too much/cannot afford it, 52 (24.5%) reported membership in another organization, 38 (17.9%) reported that membership is *not* worth it/limited benefits, and 41 (19.3%) reported that there were other reasons for *not* having membership in ASCA.

The majority of the participants were White-Caucasian female respondents, which was a common finding in school counseling research (e.g., Harris, 2013; Limberg, 2013; Moyer, Sullivan, & Growcock, 2012). Furthermore, the participants' age in this study averaged 43.2 years, which was consistent with other studies that range from 42 - 46 years (e.g., Bodenhorn, 2006; Clemens, Milsom, & Cashwell, 2009; Limberg, 2013). Similar to other research (Harris, 2013; Ieva, 2010; Limberg, 2013), most participants in this study reported having a Master's degree for their highest degree earned. Participants' reported average number of years of experience (as a school counselor; $M = 10.4$) was consistent with similar studies, which indicates that the average number of years of experience of school counselor ranges from 6 to 11 years (Lambie et al., 2011; Limberg, 2013; Moyer et al., 2012). The majority of respondents were members of ASCA ($n = 496$; 68.4%), which was congruent with comparable studies (e.g., Lambie et al., 2011; Limberg, 2013). No research was identified that examined the rationale that school counselors did *not* hold membership in ASCA; however, these results provide some insights into potential reasons for *not* holding membership. The school counselor-participants' demographic characteristics from this study were consistent with other studies conducted with practicing school counselors using similar data collection method (e.g., Bodenhorn, 2006; Clemens, et al., 2009; Limberg, 2013), supporting the generalizability of the findings.

School Characteristics

Results of the descriptive analysis of participants setting characteristics identified that respondents' ($N = 686$) reported school levels included: (a) elementary school level ($n = 215$, 31.2%), (b) middle school level ($n = 195$, 28.3%), (c) high school level ($n = 186$, 27.0%), (d) K – 12th grade levels ($n = 47$, 6.8%), (e) 6th – 12th grade levels ($n = 23$, 3.3%), (f) K – 8th grade levels ($n = 18$, 2.6%), and (g) other grade levels ($n = 2$, 0.3%). Respondents' ($N = 686$) school type

included: (a) Regular Setting ($n = 651, 94.3\%$), (b) Alternative Education ($n = 10, 1.4\%$), Special Education ($n = 7, 1.0\%$), (d) Career Center ($n = 6, 0.9\%$), and (e) other school type ($n = 12, 1.7\%$). Regarding school agency, participants' ($N = 687$) reported type includes 91.4% ($n = 631$) public, 7.1% ($n = 49$) private, 1.0% ($n = 7$) charter, and 3 (0.4%) *not* reporting their school agency type. Concerning Title I status, 447 (64.8%) participants ($N = 686$) reported their school qualifies for Title I, 200 (29.0%) participants reported their school does *not* qualify for Title I, and 39 (5.7%) participants did *not* know if their school qualifies for Title I, with 4 (0.5%) participants *not* responding. Participants ($N = 686$) school geographical environment included: (a) Suburban ($n = 253, 36.9\%$), (b) Rural ($n = 228, 33.3\%$), and (c) Urban ($n = 204, 29.8\%$) with 4 (.5%) *not* responding.

Additional descriptive analyses identified that participants' reported school counseling program implementation included: (a) 58.8% ($n = 401$) Comprehensive Guidance and Counseling Program, (b) 56.3% ($n = 384$) ASCA *National Model*, (c) 51.8% ($n = 353$) ASCA *National Standards*, (d) 37.5% ($n = 256$) State Level Standards or Program, (e) 29.9% ($n = 170$) Developmental Guidance Program, (f) 14.4% ($n = 98$) No Specified Approach or Program, (g) 5.3% ($n = 36$) some other program, and (h) 0.1% ($n = 7$) Education Trust's *Transforming School Counseling Initiative*. Regarding participants' ($N = 682$) integration of multiple school counseling program approaches, 477 (69.9%) respondents use *two or more* approaches. Furthermore, 148 (21.4%) of the school counselors who use the integration of two approaches, 162 (23.5%) who use the integration of three approaches, and 165 (23.9%) who use the integration of four or more approaches.

The participants' reported school level was comparable to other studies (e.g., Bodenhorn, 2006; Ieva, 2010; Limberg, 2013) with elementary, middle, and high school being relatively

equality (e.g., between 27-32% of sample) represented across groups. The majority (94.3%) of the respondents worked in Regular education settings. Data on school counselors' work setting type are *not* often examined in the research, but these findings offer insight into the make-up of the participants. Most school counseling research studies (e.g., Ieva, 2010; Harris, 2013; Limberg, 2013) do *not* examine the school agency (e.g., public, private, or charter) but these results from this investigation indicate that the majority (e.g., $n = 631$; 91.4%) of the participants worked in public school versus private (e.g., $n = 49$; 7.1%) or charter (e.g., $n = 631$; 91.4%). Again, most school counseling research studies (e.g., Harris, 2013; Ieva, 2010; Limberg, 2013) do *not* examine Title I status of participants school setting but these results indicated that most respondents (e.g., $n = 447$, 64.8%) work in Title I schools, which provides insight into the characteristics of the respondents schools. The breakdown of respondents school location (e.g., rural, suburban, or urban) was evenly distributed across groups (e.g., ranging from 29.8% to 36.9%) with was consistent with findings from similar studies (e.g., Clemens et al., 2009; Harris, 2013; Wilkerson, 2009). Limited research examines school counselors' programmatic implementation model; however, this investigation identified similar results to other studies (e.g., Bodenhorn et al., 2010), including that: (a) few (14.4%) school counselor implement *no* program, (b) few (0.1%) school counselors implement Education Trusts *Transforming School Counseling Initiative*, and (c) the majority of participants (69.9%) integrate more than one program. Overall, the descriptive analysis results for the participants setting characteristics were congruent with other school counseling studies (e.g., Clemens et al., 2009; Harris, 2013; Ieva, 2010; Wilkerson, 2009).

Likert Demographic Items

Additional other demographic questionnaire items included Likert demographic scaling questions that sought to examine key factors that influence the work of school counselors. Specifically, the demographic questionnaire Likert scale items measured the constructs of: (a) principal-counselor relationship, (b) work stress, (c) work satisfaction, and (d) perceived job control. These topics were selected because they were found to have a relationship to school counselor programmatic service delivery in prior research (e.g., Butler & Constantine, 2005; Cervoni & DeLucia-Waack, 2011; Clemens et al., 2009; Falls & Nichter, 2007). Each construct was measured through the use of a researcher-developed scale that underwent scale development procedures (e.g., DeVellis, 2012) and consists of three items per construct. All items followed a five-point value system ranging one (Strongly Disagree) to five (Strongly Agree). The following section presents the results regarding the constructs measured within the Likert scale questions.

Principal-counselor relationship. The Principal-Counselor Relationship scale (items 1-3) had a Cronbach's α of .927, indicating a high degree of internal reliability (Hair et al., 2006; Osborne, 2013). The scores on all three items indicated that respondents ($n = 679$) reported favorable of their relationships with their principal. Item one had a mean score of 4.16 ($SD = 1.00$), item two had a mean score of 4.16 ($SD = 1.00$), and item three had a mean score of 4.19 ($SD = 1.00$). Furthermore, the averaged scale score for these three items indicated that respondents ($n = 679$) reported favorable of their relationships with their principal ($M = 4.16$, $SD = 0.95$). Noteworthy, the principal-counselor relationships scale had a negative skew ($Z_{Skewness} = 13.08$) and positive kurtosis ($Z_{Kurtosis} = 5.72$), indicating severe non-normality with these data. Overall, the results from the principal-counselor relationships scale should be interpreted with caution because the high internal reliability and non-normality may indicate the data does *not* accurately measure the construct (Hair et al., 2006; Osborne, 2013; Tabachnick & Fidell, 2007).

The findings in regards to the moderate level of principal-counselor relationship are consistent with other research on the topic. Specifically, Clemens et al. (2009) found that school counselors ($N = 188$) reported moderately positive relationship with their principals ($M = 3.82$, $SD = .99$, Scale Range = 1 to 5). Furthermore, Janson, Militello, and Kosine (2008) found, using a Q-Methodology research investigation, that school counselors and principals ($N = 39$) share four key viewpoints that accounted for 60% of the variance, including (a) working alliance, (b) impediments to alliance, (c) shared leadership, and (d) purposeful collaboration. Of these viewpoints, working alliance accounted for the largest variance (32%) and represented that principals' support and recognize the expertise of school counselors. These findings support that school counselors have a tendency to feel there is a supportive relationship with their principal. The findings from Clemens and colleagues (2009) and Janson and colleagues (2008) were similar to the findings with this study. The relationship between principal-counselor in relationship to self-efficacy, professional quality of life, and programmatic service delivery is discussed in further detail later in this chapter.

Work stress. The Work Stress scale (items 4-6) had a Cronbach's α of .741, indicating sound to moderate internal consistency reliability (Hair et al., 2006; Osborne, 2013). The scores on all three items indicated that respondents ($n = 679$) reported a moderate level of stress on the job. Item one had a mean score of 3.40 ($SD = 1.08$), item two had a mean score of 3.76 ($SD = 0.99$), and item three had a mean score of 2.37 ($SD = 1.14$). Furthermore, the averaged scale score for these three items indicated that respondents ($n = 679$) reported moderate level of stress on the job ($M = 3.14$, $SD = 0.69$). Noteworthy, the work stress scale was normally distributed ($Z_{Skewness} = 0.87$; $Z_{Kurtosis} = 1.48$).

The findings relating to school counselors' stress levels were consistent with similar research. Rayle (2006) found that school counselors ($N = 388$) who had prior teaching experience has moderate level of job-related stress ($M = 3.40$, $SD = .63$, Scale Range = 1 to 5) and school counselors who did *not* have prior teaching experience had high levels of stress ($M = 4.20$, $SD = .63$). However, McCarthy, Van Horn, Kerne, Caifa, Lambert, and Guzman (2010) found low levels ($M = 1.64$, $SD = .66$, Scale Range = 1 to 4) of reported stress in school counselors ($N = 209$). These findings were inconsistent and merit further inquiry. The variance in results may derive from the sampling population and size. Both this investigation and Rayle's (2006) have adequate sample sizes for generalizability but McCarthy and colleagues have a smaller sample size. Furthermore, both Rayle (2006) and McCarthy and colleagues use the *School Counselor Job Stress Assessment* (Rayle, 2006), which may produce difference results than the researcher made questionnaire in this study. Nevertheless, the research indicates a higher propensity for counselors to have moderate levels of stress. The relationship between work stress in relationship to self-efficacy, professional quality of life, and programmatic service delivery is discussed in further detail later in this chapter.

Work satisfaction. The Work Satisfaction scale (items 7-9) had a Cronbach's α of .755, indicating sound to moderate internal consistency reliability (Hair et al., 2006; Osborne, 2013). The scores on all three items indicated that respondents ($n = 679$) reported high satisfaction on the job. Item one had a mean score of 4.51 ($SD = 0.70$), item two had a mean score of 4.52 ($SD = 0.72$), and item three had a mean score of 4.08 ($SD = 1.07$). Furthermore, the averaged scale score for these three items indicted that respondents ($n = 679$) reported high satisfaction on the job ($M = 4.37$, $SD = 0.69$). Noteworthy, the work satisfaction scale had a negative skew ($Z_{Skewness} = 14.19$) and positive kurtosis ($Z_{Kurtosis} = 11.76$), which indicates severe non-normality (Hair et

al., 2006; Osborne, 2013). Overall, the results from the work satisfaction scale should be interpreted with caution because the non-normality may indicate the data does *not* accurately measure the construct (Hair et al., 2006; Osborne, 2013; Tabachnick & Fidell, 2007).

The findings regarding work satisfaction were similar to other studies (e.g., Clemens et al., 2009). Clemens and colleagues (2009) found that school counselors ($N = 188$) reported a moderately positive level of job satisfaction ($M = 3.23$, $SD = .48$, Scale Range = 1 to 5). Furthermore, Payne (2011) found that school counselors ($N = 103$) were satisfied with their jobs ($M = 43$, $SD = 11.3$, Scale Range = 1 to 72). Additionally, Baggerly and Osborne (2011) found that school counselors ($N = 1,280$) reported being satisfied with their career ($M = 3.20$, $SD = .79$). The findings from prior research and this study identify that, in general, school counselors are satisfied with their career (Baggerly & Osborne, 2011; Clemens et al., 2009; Payne, 2011). The relationship between work satisfaction in relationship to self-efficacy, professional quality of life, and programmatic service delivery is discussed in further detail later in this chapter.

Perceived job control. The Perceived Job Control scale (items 10-12) had a Cronbach's α of .615, indicating an acceptable to questionable degree of internal reliability (Hair et al., 2006; Osborne, 2013). The scores on all three items indicated that respondents ($n = 679$) reported a high degree of job control. Item one had a mean score of 2.37 ($SD = 1.14$), item two had a mean score of 3.85 ($SD = 1.05$), and item three had a mean score of 3.11 ($SD = 1.07$). Furthermore, the averaged scale score for these three items indicated that respondents ($n = 679$) reported a high degree of job control ($M = 3.55$, $SD = 0.77$). Noteworthy, the perceived job control scale had a negative skew ($Z_{Skewness} = 5.414$) and positive kurtosis ($Z_{Kurtosis} = 2.13$), which indicates non-normality. Overall, the results from the work satisfaction scale should be interpreted with caution

because the non-normality may indicate the data does *not* accurately measure the construct (Hair et al., 2006; Osborne, 2013; Tabachnick & Fidell, 2007).

No research was identified that examined the construct of perceived job control and school counselors; however, similar constructs have been researched. Specifically, Clemens and colleagues (2009) examined the construct of principal-decision sharing (e.g., principal affording school counselors decision-making responsibility) and found that principals give school counselors ($N = 188$) a moderate level of responsibility in relationship to school-based decision-making ($M = 3.52$, $SD = .92$, Scale Range = 1 to 5), supporting the findings from this investigation. Furthermore, Scarborough and Culbreth (2008) found a statistically significant difference between what school counselors prefer to do and what they actually do indicate ($t = -21.22$, $p < .001$, $d = 1.02$), indicating that they don't have control over what they would like to do as a school counselor. In addition, Burnham and Jackson (2000) found that school counselors ($N = 80$) on average spend 25.04% ($SD = 17.42$) of their time attending to non-guidance activities, which represents systemic reasons for *not* complete the activities (essential tasks) they would prefer. These studies report similar or related findings. Research indicates that school counselors have moderate control over what they do on the job but there exists factors (e.g., systemic issues) that prevent them from having complete control over their activities (Burnham & Jackson, 2000; Clemens et al., 2009; Scarborough & Culbreth, 2008). The relationship between perceived job control in relationship to self-efficacy, professional quality of life, and programmatic service delivery is discussed in further detail later in this chapter.

Overall, the findings from the other demographic factors were either: (a) consistent with previous research findings or (b) initial investigations (limited prior research) into the identified

areas. These results are further discussed in the implications and future research directions section of this chapter.

Instrumentation and Measurement Model

Three instruments were used in this study. The SCSEs (Bodenhorn & Skaggs, 2005) was used to measure school counselor self-efficacy. The ProQOLs (Stamm, 2010) was used to school counselor professional quality of life. The SCARS (Scarborough, 2005) was used to measure programmatic service delivery. The construction of the measurement model for these three instruments would traditionally require a Confirmatory Factor Analysis (CFA). However, upon initial review, the data did *not* fit well and many of the items on each instrument were removed to improve model fit. Therefore, Exploratory Factor Analysis (EFA) was used to identify the item factor loadings and a follow-up CFA was used to confirm model fit. The resulting measurement model were cross-referenced with the items on the instruments to confirm they identified factor-item connections were theoretically sound. The CFAs for each instrument for these data is described in the following section.

School Counselor Professional Quality of Life

The ProQOLs (Stamm, 2010) was used to assess school counselors' professional quality of life. The ProQOLs includes 30 items with three subscales, including: including: (a) compassion satisfaction (10 items), (b) burnout (10 items), and (c) secondary traumatic stress (10 items). The ProQOLs utilizes a five-point Likert scale ranging from 1 (Rarely) to 5 (Very Often). Cronbach's α for the initial entire ProQOLs scale (all 30 items) was .618 with these data, which is questionable (Hair et al., 2006). The Cronbach's α for the scales were: Compassion Satisfaction scale ($\alpha = .872$), Burnout scale ($\alpha = .771$), and Secondary Traumatic Stress scale (α

= .705), which were within appropriate α levels (Hair et al., 2006) and were consistent with prior research (Lawson, 2007; Lawson & Meyers, 2011; Stamm, 2010).

A review of the measures of central tendencies for the initial ProQOLs and its scales indicates the respondents reported high levels of compassion satisfaction and moderate levels of burnout and secondary traumatic stress. Specifically, the central tendencies were: (a) Burnout (10 items; $M = 20.22$, $SD = 4.87$, Range = 10 to 36, $Mdn = 20$, Mode = 20), (b) Secondary Traumatic Stress (10 items; $M = 18.75$, $SD = 4.10$, Range = 10 to 32, $Mdn = 18$, Mode = 17), and (c) Compassion Satisfaction (10 items; $M = 43.16$, $SD = 4.48$, Range = 27 to 50, $Mdn = 44$, Mode = 43). The total ProQOLs scale averaged 77.60 ($SD = 6.67$, Range = 57 to 97, $Mdn = 77$, Mode = 77). The findings in this study were similar to previous research. Specifically, Lawson (2007) found the central tendencies were: (a) Burnout ($M = 18.37$, $SD = 6.00$; Alpha = .82), (b) Compassion Fatigue ($M = 10.05$, $SD = 5.91$; Alpha = .85), and (c) Compassion Satisfaction ($M = 39.84$, $SD = 6.43$; Alpha = .77). Furthermore, Lawson and Meyers (2011) found the central tendencies were: (a) Burnout ($M = 19.93$, $SD = 5.96$), (b) Compassion Fatigue ($M = 10.32$, $SD = 5.98$) and (c) Compassion Satisfaction ($M = 40.52$, $SD = 5.57$).

The initial CFA for the ProQOLs was based upon the theorized structure (Stamm, 2010); however, the CFA did *not* fit the theorized model structure due to poor factor loading (e.g., cross-loading and low factor loading [$< .3$]) and required the removal of a significant number of items (more than 50%). It is noteworthy that the ProQOLs was *not* validated for school counselors. Therefore, an EFA was used to identify the factor structure (Hair et al., 2006; Tabachnick & Fidell, 2007), identifying a three factor solution with 10-items from the original SCSEs. The percent variance explained accounted for 66.44% of total variance, which is satisfactory in social science research (Hair et al., 2006). Bartlett's test of Sphericity produced a

statistically significant value ($\chi^2 = 1753.10$, $df = 45$, $p < .001$), indicating that the data were correlated. The analysis resulted in a KMO measure of sampling adequacy index of .78, which is commendable (Dimitrov, 2012; Hair et al., 2006). ProQOLs factor one represents Compassion Satisfaction, factor two represents Burnout, and factor three represents Secondary Traumatic Stress. A review of the ProQOLs items (e.g., question content) and theoretical groundwork (e.g., Stamm, 2010) supported the assignment of factor labels.

A review of the central tendencies for the modified ProQOLs and its scales indicates the respondents reported high levels of compassion satisfaction and moderate levels of burnout and secondary traumatic stress. Specifically, the central tendencies are: (a) Burnout (3 items, $M = 9.03$, $SD = 2.81$, Range = 3 to 15, $Mdn = 9$, Mode = 8), (b) Secondary Traumatic Stress (3 items, $M = 4.54$, $SD = 1.56$, Range = 3 to 11, $Mdn = 4$, Mode = 3), (c) Compassion Satisfaction (4 items, $M = 17.22$, $SD = 2.20$, Range = 10 to 20, $Mdn = 17$, Mode = 20), and (d) total score (10 items, $M = 30.79$, $SD = 3.70$, Range = 21 to 42, $Mdn = 31$, Mode = 30). Additionally, the Cronbach's α for the modified scales were: Compassion Satisfaction scale ($\alpha = .791$), Burnout scale ($\alpha = .798$), and Secondary Traumatic Stress scale ($\alpha = .791$), which are within appropriate α levels (Hair et al., 2006) but are lower than prior research (Lawson, 2007; Lawson & Meyers, 2011; Stamm, 2010), which is attributed to the modifications made based on the EFA that improved the psychometrics properties of instrument by removing poor items with these data.

A CFA was conducted using the modified ProQOLs measurement model. The three-factor model produced a chi-square of 59.65 ($df = 32$, $p < .001$), Goodness of fit Index (GFI) of .974, Comparative Fit Index (CFI) of .951, Root Mean Squared Error of Approximation (RMSEA) of .039, and Standardized Root Mean Squared Residual (SRMR) of .036. According

to these fit indices, the measurement model of the modified ProQOLs structure had a good fit with these data.

School Counselor Self-Efficacy

The SCSEs (Bodenhorn & Skaggs, 2005) was used to identify school counselors' report of self-efficacy. The SCSEs includes 43 items with five scales, which includes: (a) personal and social development (12 items), (b) leadership and assessment (9 items), (c) career and assessment (7 items), (d) collaboration (11 items), and (e) cultural awareness (four items). The SCSEs utilizes a five-point Likert scale ranging from 1 (Not Confident) to 5 (Highly Confident). The initial Cronbach's α for the entire SCSEs scale (all 43 items) was .959, identifying high internal consistency reliability (Hair et al., 2006). The initial Cronbach's α for the scales were: (a) Personal and Social Development scale ($\alpha = .863$), (b) Leadership and Assessment scale ($\alpha = .892$), (c) Career and Academic Development scale ($\alpha = .828$), (d) Collaboration scale ($\alpha = .807$), and Cultural Awareness scale ($\alpha = .621$). All of the SCSEs scales had an acceptable internal reliability coefficient (Hair et al., 2006) and were consistent with prior research using the SCSEs (e.g., Bodenhorn & Skaggs, 2005; Bodenhorn et al., 2010; Scoles, 2011).

A review of the measures of central tendency for the initial SCSEs and its scales indicates the respondents reported high levels of self-efficacy. Specifically, the measures of central tendencies are: (a) personal and social development (12 items; $M = 52.15$, $SD = 5.42$, Range = 37 to 60, $Mdn = 52$, Mode = 49), (b) leadership and assessment (9 items; $M = 34.52$, $SD = 6.13$, Range = 14 to 45, $Mdn = 34$, Mode = 33), (c) career and academic development (7 items; $M = 28.77$, $SD = 4.02$, Range = 16 to 35, $Mdn = 29$, Mode = 28), (d) collaboration (11 items; $M = 48.22$, $SD = 4.85$, Range = 34 to 55, $Mdn = 49$, Mode = 55), and (e) cultural awareness (4 items; $M = 17.09$, $SD = 2.09$, Range = 11 to 20, $Mdn = 17$, Mode = 17). The total SCSEs scale averaged

180.75 ($SD = 19.46$, Range = 126 to 215, $Mdn = 179$, Mode = 171). The SCSEs results from this study were similar to previous findings with practicing school counselors. Specifically, Bodenhorn and Skaggs (2005) found a total score average of 180.97 ($SD = 19.86$). Furthermore, Clark (2006) found the measures of central tendencies for the items average scores were: (a) personal and social development ($M = 4.17$, $SD = 0.53$), (b) leadership and assessment ($M = 4.15$, $SD = 0.61$), (c) career and academic development ($M = 4.41$, $SD = 0.57$), (d) collaboration ($M = 4.08$, $SD = 0.58$) and (e) cultural awareness ($M = 4.09$, $SD = 0.69$) as compared to the item average scores from this study that includes: (a) personal and social development ($M = 4.34$, $SD = 0.45$), (b) leadership and assessment ($M = 3.83$, $SD = 0.68$), (c) career and academic development ($M = 4.11$, $SD = 0.57$), (d) collaboration ($M = 4.38$, $SD = 0.44$) and (e) cultural awareness ($M = 4.27$, $SD = 0.52$).

The initial CFA was based upon the scale development study that was used to construct the SCSEs (Bodenhorn & Skaggs, 2005); however, the CFA did *not* fit the model due to poor factor loading (e.g., cross-loading and low factor loading [$< .3$]) and required the removal of a significant number of items (more than 50%). Therefore, the researcher utilized an EFA to use the data to identify the factor structure (Hair et al., 2006; Tabachnick & Fidell, 2007). The resulting EFA (described in detail in chapter four) resulted in a four factor solution with 12-items from the original SCSEs. The percent variance explained accounted for 67.67% of total variance, which is satisfactory in social science research (Hair et al., 2006). Bartlett's test of Sphericity produced a statistically significant value ($\chi^2 = 2612.36$, $df = 66$, $p < .001$), indicating that the data were correlated. The analysis resulted in a KMO measure of sampling adequacy index of .91, which is commendable (Dimitrov, 2012; Hair et al., 2006). SCSEs factor one represents Leadership and Assessment Self-Efficacy, factor two represents Career and Academic

Development Self-Efficacy, factor three represents Personal/Social Development Self-Efficacy, and factor four represents Collaboration Self-Efficacy. The original structure of the SCSEs included a subscale on Cultural Awareness Self-Efficacy; however, the results of the EFA did *not* support this scale with these data. A review of the SCSEs items (e.g., question content) and theoretical groundwork (e.g., Bodenhorn & Skaggs, 2005) supported the assignment of factor labels.

A review of the measures of central tendencies for the modified SCSEs and its scales indicates the respondents reported high self-efficacy. Specifically, the measures of central tendencies are: (a) personal and social development (3 items; $M = 13.05$, $SD = 1.70$, Range = 6 to 15, $Mdn = 13$, Mode = 15), (b) leadership and assessment (3 items; $M = 12.07$, $SD = 2.24$, Range = 2 to 15, $Mdn = 12$, Mode = 12), (c) career and assessment (3 items; $M = 12.50$, $SD = 1.98$, Range = 6 to 15, $Mdn = 13$, Mode = 12), (d) collaboration (3 items; $M = 13.22$, $SD = 1.60$, Range = 9 to 15, $Mdn = 9$, Mode = 15), and (f) total scale averaged (12 items; $M = 50.81$, $SD = 6.07$, Range = 33 to 60, $Mdn = 51$, Mode = 60). Furthermore, the Cronbach's α for the modified SCSEs include: Leadership and Assessment Self-Efficacy scale ($\alpha = .827$), Career and Academic Development Self-Efficacy scale ($\alpha = .767$), Personal/Social Development Self-Efficacy scale ($\alpha = .745$), Collaboration Self-Efficacy scale ($\alpha = .601$), and total scale ($\alpha = .880$). Therefore, three of the SCSEs subscales had an acceptable internal reliability coefficient and one subscale (Collaboration Self-Efficacy) had a moderate to questionable Cronbach's α with these data (Hair et al., 2006). The measures of central tendency from the modified scales were similar to previous researcher (e.g., Bodenhorn & Skaggs, 2005; Clark, 2006).

A CFA was conducted using the modified measurement model. The four-factor model produced a chi-square of 68.35 ($df = 48$, $p < .001$), GFI of .968, CFI of .966, RMSEA of .027,

and SRMR of .035, identifying that the measurement model of the modified SCSEs structure was good fit with these data.

School Counselor Programmatic Service Delivery

The SCARS (Scarborough, 2005) was used to identify school counselors' reported frequency of programmatic service delivery. The SCARS includes 48 items with five scales, which includes: (a) Counseling (10 items), (b) Consultation (7 items), (c) Coordination (13 items); (d) Curriculum (8 items), and (e) Other Activities (10 items). The SCARS utilizes a five-point Likert scale ranging from 1 (Never) to 5 (Routinely). The initial Cronbach's α for the entire SCARS scale (all 48 items) was .902, identifying high internal reliability (Hair et al., 2006). The initial Cronbach's α for the scales were: (a) Counseling Activities scale ($\alpha = .839$), the Consultation Activities scale ($\alpha = .755$), Coordination scale ($\alpha = .855$), Curriculum Activities scale ($\alpha = .932$), and Other Activities scale ($\alpha = .638$). All of the SCARS scales had an acceptable internal reliability coefficient with these data with the Other Activities scale being questionable (Hair et al., 2006). These findings were similar with other school counseling studies using the SCARS (e.g., Scarborough, 2005; Shillingford & Lambie, 2010; Woods, 2009).

A review of the measures of central tendencies for the initial SCARS and its scales indicates the respondents reported high levels of service delivery. Specifically, the measures of central tendencies for were: (a) Consultation (7 items; $M = 26.27$, $SD = 4.60$, Range = 10 to 35, $Mdn = 26$, Mode = 28), (b) Counseling (10 items; $M = 35.75$, $SD = 6.36$, Range = 14 to 50, $Mdn = 36$, Mode = 37), (c) Coordination (13 items; $M = 42.07$, $SD = 9.05$, Range = 14 to 65, $Mdn = 42$, Mode = 41); (d) Curriculum (8 items; $M = 26.66$, $SD = 8.62$, Range = 8 to 40, $Mdn = 27$, Mode = 36), and (e) Other Activities (10 items; $M = 30.49$, $SD = 7.12$, Range = 10 to 50, $Mdn = 30$, Mode = 28). The total SCARS scale averaged 161.22 ($SD = 24.54$, Range = 66 to 240, $Mdn =$

163, Mode = 171). The findings from this study were similar to previous studies. Specifically, Shillingford and Lambie (2010) found the measures of central tendencies for the scale average scores were: (a) Coordination ($M = 39.34$, $SD = 8.86$), (b) Counseling ($M = 33.41$, $SD = 6.95$), (c) Other Activities ($M = 32.08$, $SD = 6.56$), (d) Consultation, ($M = 26.47$, $SD = 4.91$), and (e) Curriculum ($M = 22.40$, $SD = 8.05$). In addition, Scarborough and Culbreth (2008) found the measures of central tendencies for the items average scores were: (a) Coordination ($M = 2.88$, $SD = 0.69$), (b) Counseling ($M = 3.06$, $SD = 0.70$), (c) Counseling, ($M = 3.57$, $SD = 0.63$), and (d) Curriculum ($M = 2.68$, $SD = 0.63$), which is similar as compared to the finding from this study that include item average scores of: (a) Consultation ($M = 3.75$, $SD = 0.65$), (b) Consultation ($M = 3.76$, $SD = .48$), (c) Coordination ($M = 3.23$, $SD = 0.69$); (d) Curriculum (8 items, $M = 3.33$, $SD = 1.03$).

The initial CFA was based upon the scale development study that was used to construct the SCARS (Scarborough, 2005); however, the CFA did *not* fit the data for this model due to poor factor loading (e.g., cross-loading and low factor loading [$< .3$]) and required the removal of a significant number of items (more than 50%). Therefore, the researcher utilized an EFA to use the data to identify the factor structure (Hair et al., 2006; Tabachnick & Fidell, 2007). The resulting EFA (described in detail in chapter four) formed a four factor solution with 13-items from the original SCARS. The percent variance explained accounted for 74.40% of total variance, which is satisfactory in social science research (Hair et al., 2006). Bartlett's test of Sphericity produced a statistically significant value ($\chi^2 = 4241.96$, $df = 78$, $p < .001$), indicating that the data were correlated. The analysis resulted in a KMO measure of sampling adequacy index of .88, which is commendable (Dimitrov, 2012; Hair et al., 2006). SCARS factor one represents Curriculum Service Delivery, factor two represents Counseling Service Delivery,

factor three represents Consultation Service Delivery, and factor four represents Coordination Service Delivery. The original structure of the SCARS included a subscale on Other Activities; however, the results of the EFA did *not* support this scale with these data. However, the elimination of the Other Activities scale was consistent with similar studies (e.g., Shillingford & Lambie, 2010) with practicing school counselors. A review of the SCARS items (e.g., question content) and theoretical groundwork (e.g., Scarborough, 2005) supported the assignment of factor labels.

A review of the measures of central tendencies for the modified SCARS and its scales indicates the respondents reported a high frequency of service delivery. Specifically, the measures of central tendencies are: (a) *Counseling* (3 items; $M = 8.92$, $SD = 3.20$, Range = 3 to 15, $Mdn = 9$, Mode = 9), (b) *Consultation* (3 items; $M = 10.98$, $SD = 2.43$, Range = 3 to 15, $Mdn = 11$, Mode = 12), (c) *Coordination* (3 items; $M = 10.06$, $SD = 2.48$, Range = 3 to 15, $Mdn = 10$, Mode = 10); and (d) *Curriculum* (4 items; $M = 13.16$, $SD = 5.01$, Range = 4 to 20, $Mdn = 14$, Mode = 20). The total modified SCARS scale averaged 43.10 (13 items; $SD = 10.07$, Range = 13 to 65, $Mdn = 44$, Mode = 43). Furthermore, the Cronbach's α for the entire modified SCARS scale (all 13 items) was .891, which was acceptable (Hair et al., 2006). The Cronbach's α for the modified SCARS scales were: (a) Curriculum Service Delivery scale ($\alpha = .933$), (b) Counseling Service Delivery scale ($\alpha = .844$), Consultation Service Delivery scale ($\alpha = .742$), and (d) Coordination Service Delivery scale ($\alpha = .748$). All four of the SCARS subscales scales had acceptable internal reliability with these data (Hair et al., 2006).

A CFA was conducted using the modified measurement model. The four-factor model produced a chi-square of 125.90 ($df = 71$, $p < .001$), GFI of .970, CFI of .963, RMSEA of .037,

and SRMR of .035. According to these fit indices, the measurement model of the modified SCARS structure had a good fit with these data.

Complete Measurement Model

The complete measurement model included the modified measurement models (e.g., CFAs) based on these data ($N = 577$), supporting a good fit for these data. The complete measurement mode resulted in a chi-square of 775.99 ($df = 505, p < .001$), GFI of .931, CFI of .696, RMSEA of .031, and SRMR of .036.

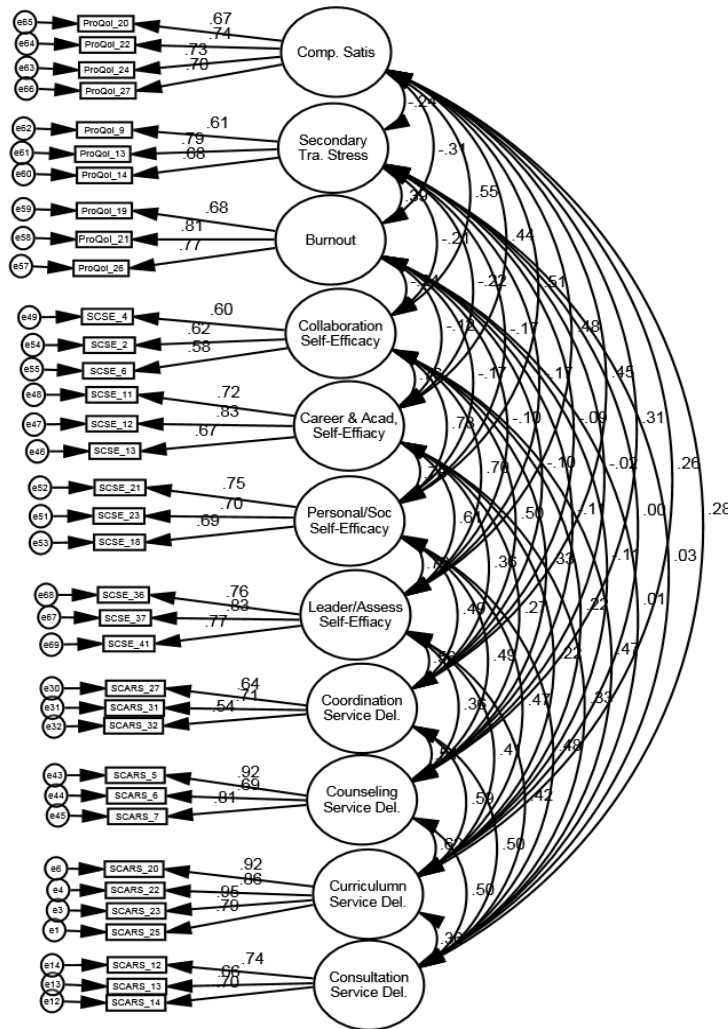

Figure 23: Complete Measurement Model

Parceled Measurement Model

A parceled measurement model based was developed based on these data ($N = 577$), which supported a good fit for these data. The parceled measurement model resulted in a chi-square of 199.78 ($df = 41, p < .001$), GFI of .939, CFI of .912, RMSEA of .082, and SRMR of .058.

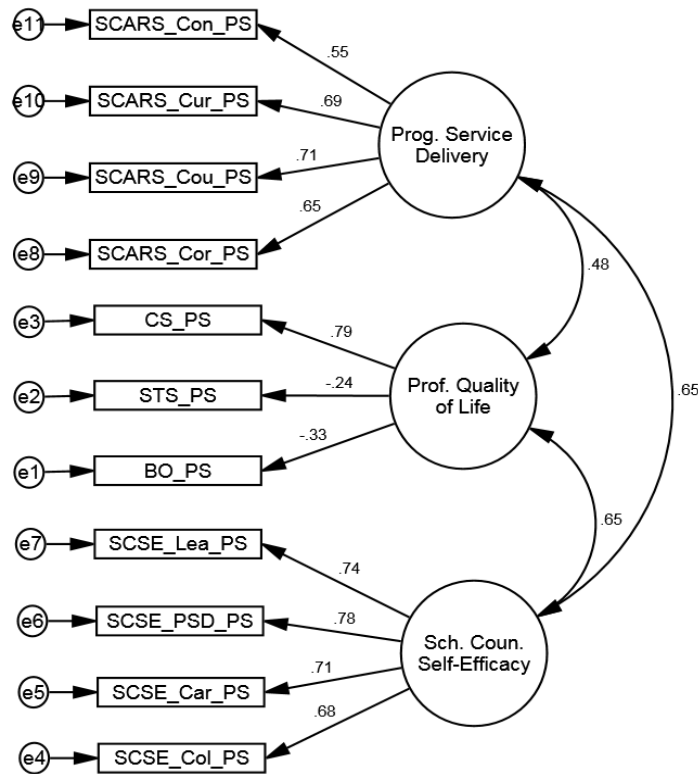

Figure 24: Parceled Measurement Model

Primary Research Question Results

Primary Research Question

Do practicing school counselors' levels of professional quality of life (as measured by the *Professional Quality of Life Scale* [ProQOLs; Stamm, 2010]) and their self-efficacy (as measured by the *School Counselor Self-Efficacy Scale* [SCSEs; Bodenhorn & Skaggs, 2005])

contribute to their levels of service delivery (as measured by the *School Counselor Activity Ratings Scale* [SCARS; Scarborough, 2005])?

Research Hypothesis

School counselors' professional quality of life (as measured by the *ProQOLs* [Stamm, 2010]) and their self-efficacy (as measured by the *SCSEs* [Bodenhorn & Skaggs, 2005]) contributed to their service delivery (as measured by the *SCARS* [Scarborough, 2005]). Specifically, this investigation tested the hypothesized directional relationship that practicing school counselors scoring at higher levels of professional quality of life and higher levels of self-efficacy would have higher levels of service delivery (see figure 25).

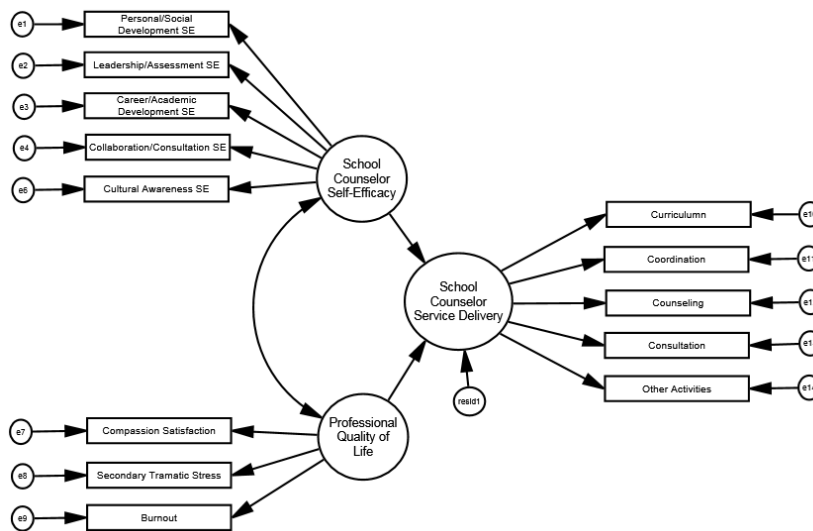

Figure 25: Path Diagram of the Structural Model to be tested

To answer the research question and test the hypothesis a structural model was created (developed from the measurement models; see figures 12, 14, 16, and 22) and tested. The model that was developed resulted in a chi-square of 120.798 ($df = 37, p < .001$), GFI of .963, CFI of .953, RMSEA of .063, and SRMR of .045 which indicated a good model fit with these data. The tested model indicated that professional quality of life accounts for 1.21% (standardized

coefficient = .11) of variance in programmatic service delivery, self-efficacy accounts for 34.81% (standardized coefficient = .59) of variance in programmatic service delivery, and the covariance of professional quality of life and self-efficacy accounted for 26% (standardized coefficient = .51) of the variable between the constructs. The relationship between professional quality of life and programmatic service delivery was negative, suggesting that when a respondent reported high professional quality of life they demonstrated high frequency of service delivery. However, the practical significant for this finding was minimal due to a low standardized coefficient (.11). In addition, the relationship between self-efficacy and programmatic service delivery was positive (.59), suggesting that as a respondents reported higher self-efficacy they demonstrated a higher frequency of service delivery. Furthermore, the relationship between professional quality of life and self-efficacy was positive (.51), suggesting that as a respondent reported higher professional quality of life they also reported higher self-efficacy. Based on these findings, the hypothesis that practicing school counselors scoring at higher levels of professional quality of life and higher levels of self-efficacy would have higher levels of service delivery was accepted.

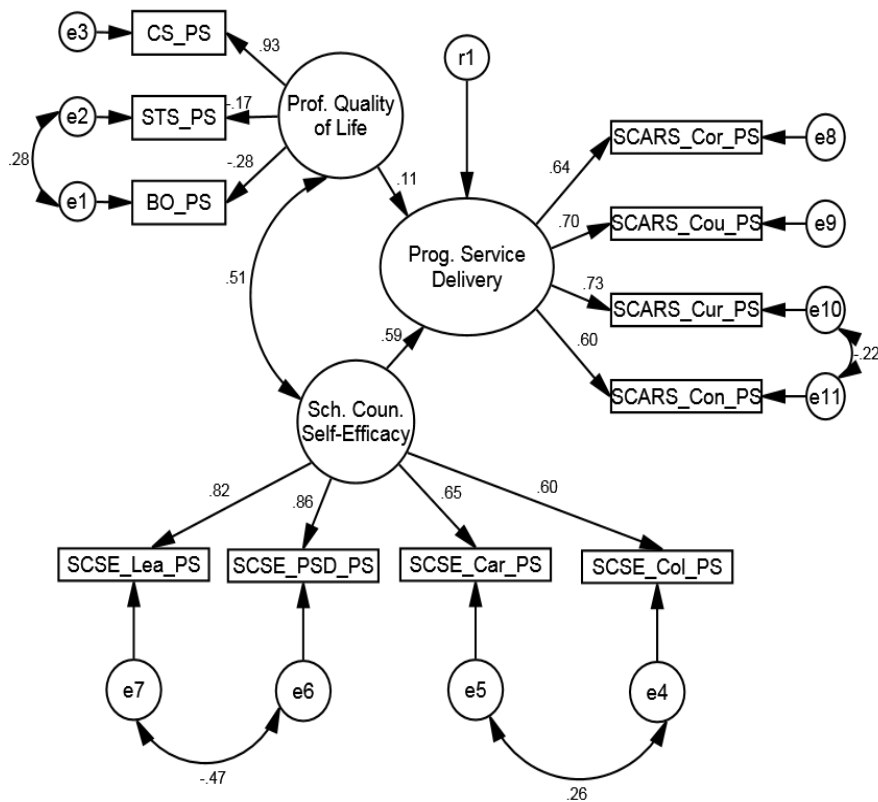

Figure 26: Modified Structural Model

Post-Hoc Analysis

To further examine the model an equivalent second-order model was tested. To test the second-order structural model a complete second-order measurement model was constructed based on the individual measurement models. The complete second-order measurement model was developed based on these data ($N = 577$), which supported a good fit for these data. The second-order measurement model resulted in a chi-square of 979.47 ($df = 541, p < .001$), GFI of .912, CFI of .951, RMSEA of .037, and SRMR of .054.

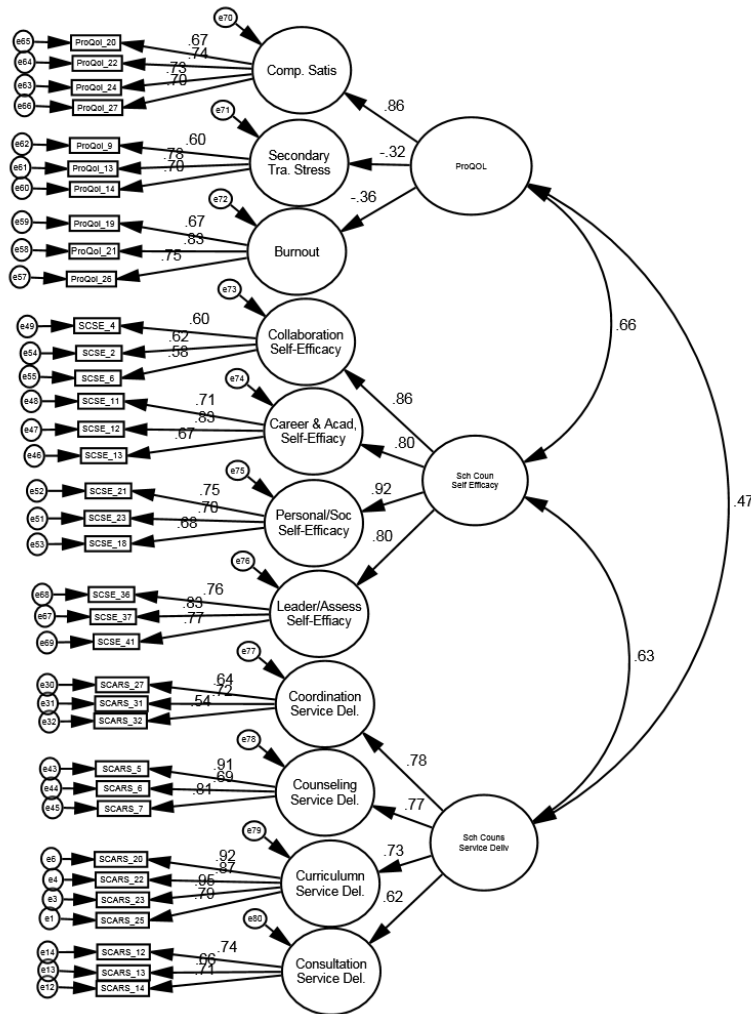

Figure 27: Complete Second-Order Measurement Model

Next, the second-order measurement model was converted into a structural model. The second-order model resulted in a chi-square of 979.47 ($df = 546, p < .001$), GFI of .912, CFI of .951, RMSEA of .037, and SRMR of .054 which indicated a good model fit with these data.

Furthermore, the factor loading between secondary traumatic stress and professional quality of life improved from -.17 on the initial model to -.31 on the second order model. Therefore, the second-order model included a stronger measurement for professional quality of life (Kline, 2011). The second-order model indicated that professional quality of life accounted for 1.00% (standardized coefficient = .10) of variance in programmatic service delivery, self-efficacy

accounted for 32.49% (standardized coefficient = .57) of variance in programmatic service delivery, and the correlation of professional quality of life and self-efficacy accounted for 43.56% (standardized coefficient = .66) of the variability between the constructs. The relationship between professional quality of life and programmatic service delivery was positive, suggesting that when a respondent reported high professional quality of life they demonstrated high frequency of service delivery. However, the practical significant for this finding is minimal due to a low standardized coefficient (.10). In addition, the relationship between self-efficacy and programmatic service delivery was positive (.57), suggesting that as a respondent reported higher self-efficacy they demonstrated a higher frequency of service delivery. Furthermore, the relationship between professional quality of life and self-efficacy was positive (.66), suggesting that as a respondent reported high professional quality of life they also reported high self-efficacy. Based on these findings, the hypothesis that practicing school counselors scoring at higher levels of professional quality of life and higher levels of self-efficacy would have higher levels of service delivery was accepted.

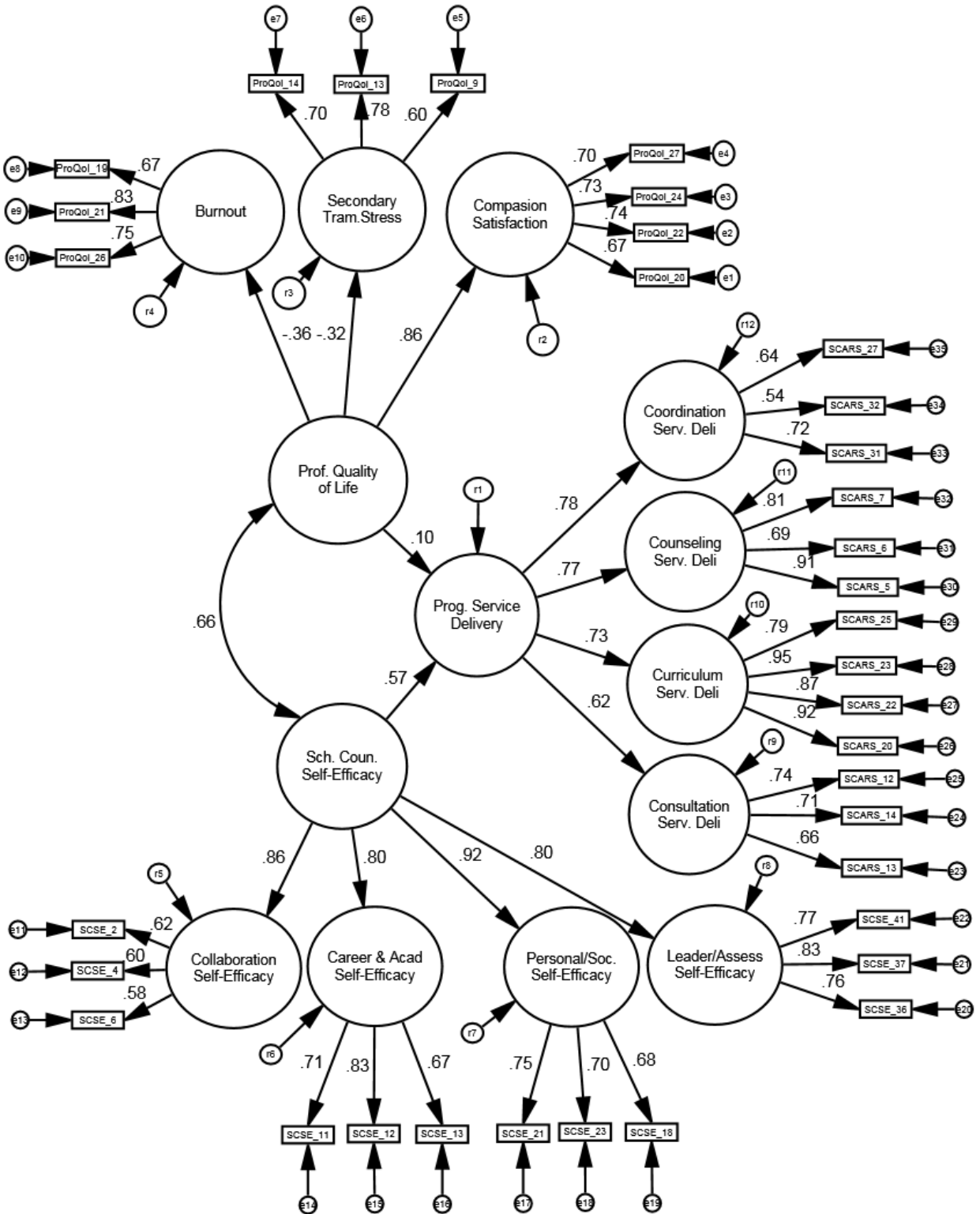

Figure 28: Modified Second-Order Structural Model

Follow-Up Analysis

A multiple linear regression (MLR) was conducted to examine if professional quality of life (independent variable) and self-efficacy (independent variable) predicts programmatic service delivery (dependent variable). The total scores of the modified data collection instruments (e.g., SCSEs, ProQOLs, and SCARS) based on the measurement models was analyzed using MLR. The data was transformed using power transformations and *all* assumptions were met. The linear composite of the predictor variables (modified SCSE and ProQOLs total score) predicted approximately 24.9% ($r = .499$) of the variance in the school counselors' frequency of programmatic service delivery, $F(2, 574) = 94.98, p < .001$. Both predictor variables had statistically significant beta coefficients for the dependent variable frequency programmatic service delivery. School counselor self-efficacy had the highest beta value ($\beta = .481, p < .001$) and professional quality of life had the next highest beta value ($\beta = .092, p = .012$).

In addition, the researcher explored the bivariate correlations of the transformed total scale scores for the modified data collection instruments (e.g., SCSEs, ProQOLs, and SCARS) using Pearson-Moment correlation coefficients. The programmatic service delivery had a statistically significant relationship with self-efficacy ($r = .489, p < .001$; 23.9% of the variance explained), which was consistent with previous research (e.g., Clark, 2006; Ernst, 2012; Woods, 2009).

Discussion of the Results for the Hypothesis

Theoretically, self-efficacy was identified as a factor that contributes to an individual's motivation to complete a task (Bandura, 1997). Ernst (2012) found a statistically significant relationship between self-efficacy and programmatic service delivery ($r = .52, p < .001$),

indicating that respondents who report higher self-efficacy also report a higher frequency of service delivery. Scarborough and Culbreth (2008) found that school counselors' outcome efficacy (as measured by the *Counselor Self-Efficacy Scale* [Sutton & Fall, 1995]) correlated with service delivery (as measured by the SCARS [Scarborough, 2005]; $r = .35$, $p < .001$, 12.2% of the variance explained). Furthermore, Scarborough and Culbreth (2008) found that school counselors' ($N = 361$) outcome efficacy predicted 9% ($r = .3$) of the variance in the school counselors' frequency of programmatic service delivery, $F(3, 343) = 39.78$, $p < .001$, $\beta = .18$. Scarborough and Culbreth (2008) finding was moderate (Cohen, 1988) and supported the findings from this investigation that self-efficacy contributes to service delivery. Moreover, Ernst (2008) found that school counselors' ($N = 515$) self-efficacy (as measured by the SCSE [Bodenhorn & Skaggs, 2005]) predicted 26% ($r = .067$) of the variance in their service delivery (as measured by the SCARS [Scarborough, 2005]), $F(1, 513) = 185.33$, $p < .001$, $\beta = .52$. These results provide additional support to the validity of this investigation, which indicates that school counselors' self-efficacy is a strong contributor to their service delivery.

There is limited published research that examines construct of professional quality of life with school counselors (e.g., Lawson, 2007; Lawson & Meyers, 2011) and no research investigating its relationship or contribution to service delivery. Furthermore, there are few studies that examine related constructs (e.g., burnout, wellness) and their relationship to service delivery (Bardhoshi, 2012; Woods, 2009). Bardhoshi (2012) and Woods (2009) examined how the service delivery activities impacted burnout, not how burnout has impacted service delivery. Specifically, Bardhoshi, (2012) found that school counselors' ($N = 252$) assignment of non-counseling duties (as measured by the SCARS [Scarborough, 2005]) predicted 10.6% ($r = .32$) of the variance in their burnout (as measured by the *Counselor Burnout Inventory* [Lee et al.,

1997]), $F(3, 248) = 9.775, p < .001, R^2 = .106$. Bardhoshi's (2012) findings, although having opposite dependent/independent variables, supports that the factors of burnout and service delivery have a relationship. Burnout is a condition that leads to diminished work effort (Freudenberger, 1978, 1989) and is produced from a chronic exposure to stress inducing environments (Maslach, 2003). Consequently, this study sought to investigate how burnout job tasks and *not* how the job tasks contribute to burnout, which resulted in finding that professional quality of life does contribute to service delivery.

Woods (2009) examined the contribution of service delivery to work wellness (as measured by the *Five Factor Wellness Inventory* [Meyers & Sweeny, 1996]) using an SEM analysis. Woods (2009) found that school counselors' ($N = 980$) completion of non-counseling duties accounted for 3.6% (standardized coefficient = .19) of variance in work wellness. This finding had a small effect size but was statistically significant ($p < .0001$). As compared to the findings in this investigation, Woods (2009) findings does *not* provide support that the directional relationship of burnout contributing to service delivery is a better fit than service delivery contributing to burnout because the findings from this investigation and Woods investigation but had a small effect size. However, the use of wellness as a factor is different than professional quality of life or burnout. Therefore, the comparison of these studies should be interpreted with caution.

No published research was identified that examined the relationship between self-efficacy and professional quality of life and limited research examines the relationship between self-efficacy and constructs related to professional quality of life (e.g., burnout, wellness; Woods, 2009). Woods (2009) found that school counselors' ($N = 980$) self-efficacy accounted for 4.8% (standardized coefficient = .22) of variance in work wellness but they did *not* examine the

covariance between these variables. Therefore, Wood's (2009) results supported the findings in this investigation. However, the relationship Woods (2009) examined varied from the theoretical relationship examine in this study. The theoretical model investigated in this study was derived from a review of the literature, which did *not* indicate a cause to believe professional quality of life would be a contributor to self-efficacy. While self-efficacy is related to individuals' believe in their ability to complete a task (Bandura, 1997), the contribution of professional quality of life on individuals' efficacy is unknown and unsupported in the literature. Additionally, Woods (2009) found a statistically significant relationship between work wellness and the personal/social development ($r = .270, p < .001$), leadership/assessment ($r = .264, p < .001$), career/academic development ($r = .181, p < .001$), collaboration ($r = .328, p < .001$), and cultural awareness ($r = .157, p < .001$) scales on the SCSEs, which indicates that as an individual report higher work wellness they report higher self-efficacy. The findings from this study support that professional quality of life and self-efficacy covary in a positive manner with these data, indicating that an increased report in professional quality of life correlates with an increased report of self-efficacy.

Summary of the Results for the Hypothesis

The results support the hypothesis that school counselors with higher levels of professional quality of life and self-efficacy have higher frequency of programmatic service delivery. However, the measurement model identification process resulted in a significant alteration to the original models but the resulting measurement models fit these data well. The results indicate that professional quality of life and self-efficacy contribute to programmatic service delivery. It's important to note that professional quality of life accounted for only 1.00% of the variance in programmatic service delivery while self-efficacy accounted for 32.49% of

variance in programmatic service delivery. Also noteworthy, the correlation of self-efficacy and professional quality of life accounted for 43.56% of their variance. Consequently, self-efficacy is a stronger contributor to programmatic service delivery than professional quality of life, and these results were congruent with prior research (e.g., Ernst, 2011; Scarborough & Culbreth, 2008; Woods, 2009).

Exploratory Research Questions

Exploratory research question one. Is there a statistically significant relationship between schools counselors' self-efficacy (as measured by the *SCSEs* [Bodenhorn & Skaggs, 2005]) and their reported demographic variables (e.g., age, gender, and ethnicity)?

The relationship between school counselors' self-efficacy and reported demographic variables was analyzed using Spearman Rank Order correlation (Rho), Krusal-Wallis H test, and Mann-Whitney U tests. This analysis used the entire sample ($N = 690$) and all items from the *SCSEs*. The results of the analyses with significant findings (moderate to high effect size; approximately $> .3$; Cohen, 1988) are discussed here.

Table 50 Spearman Rank Order Correlations Between Demographics Factors and Self-Efficacy, Participant Characteristics

	SCSEs Total Score	Personal Social Develop.	Leadership and Assessment	Career Academic Develop.	Collabo- ration	Cultural Awareness
Gender	NS	NS	NS	NS	NS	NS
Age	$\rho = .118$ $p < .01$	$\rho = .152$ $p < .001$	NS	NS	$\rho = .160$ $p < .001$	NS
Ethnicity	$\rho = -.098$ $p < .05$	NS	$\rho = -.087$ $p < .05$	$\rho = -.093$ $p < .05$	NS	$\rho = -.110$ $p < .01$
Years as a SC	$\rho = .113$ $p < .01$	$\rho = .138$ $p < .01$	NS	NS	$\rho = .156$ $p < .001$	NS
Years as a Teacher	NS	NS	$\rho = .091$ $p < .05$	$\rho = .107$ $p < .05$	NS	NS
Highest Degree	NS	NS	NS	NS	NS	NS
CACREP Graduate	NS	NS	NS	NS	NS	NS
ASCA Member	$\rho = -.197$ $p < .001$	$\rho = -.151$ $p < .001$	$\rho = -.163$ $p < .001$	$\rho = -.241$ $p < .001$	$\rho = -.176$ $p < .001$	$\rho = -.109$ $p < .001$

ASCA memberships status (e.g., whether a respondent was a member of ASCA or *not*) was found to be statistically significant with SCSEs total score ($\rho = -.202, p < .001$; 4.1% of the variance explained). A post hoc Mann-Whitney identified that there was a statistical difference ($U = 25272$; $Z = -4.828$; $p < .001$; $N = 574$; $r = .201$) in the distribution of score rankings between respondents holding membership in ASCA ($M_{rank} = 308.91$; $n = 407$) and respondents *not* currently holding membership in ASCA ($M_{rank} = 235.33$; $n = 167$). Thus, participants who were members of ASCA reported higher levels of school counselor self-efficacy.

Furthermore, ASCA memberships status (e.g., whether a respondent was a member of ASCA or *not*) was found to be statistically significant with career and academic development self-efficacy ($\rho = -.244, p < .001$; 6.0% of the variance explained). That is, respondents who reported being a current ASCA member reported higher career and academic development self-efficacy. A post hoc Mann-Whitney identified that there was a statistical difference ($U = 23457$;

$Z = -5.851; p < .001; N = 574; r = .244$) in the distribution of score rankings between respondents holding membership in ASCA ($M_{rank} = 313.37; n = 407$) and respondents *not* currently holding membership in ASCA ($M_{rank} = 224.46; n = 167$). These results indicate respondents with membership in ASCA reported a higher level of self-efficacy in terms of their work with career and academic development.

No research was identified that examined the relationship between self-efficacy and ASCA membership status; however, Clark (2009) found that an individual's knowledge of the ASCA *National Model* (a school counseling program endorsed by ASCA) predicted 17.00% ($r = .41$) of the variance in the school counselors' self-efficacy, $F(1, 108) = 21.53, p < .01$. Clark's (2009) finding relates to this investigation because ASCA member may have more familiarity with the ASCA *National model*; therefore, having higher levels of self-efficacy.

Participants amount of years of experience as a school counselor was statistically significant with total SCSEs score ($\rho = .114, p < .01$; 1.3% of the variance explained), personal social development self-efficacy ($\rho = .137, p < .01$; 1.9% of the variance explained), and collaboration self-efficacy ($\rho = .155, p < .001$; 2.4% of the variance explained). However, these findings had small effect sizes ($< .3$). These findings were different as compared to other research (e.g., Clark, 2006; Woods, 2009). The difference in results may be due to the different samples used. For example, Clark (2006) had a sample size of 110 from a single southern state and Woods (2009) has a sample of 980 but from professional associations only. Therefore, the results may be representing different populations that were sampled.

Table 51 *Spearman Rank Order Correlations between Demographics Factors and Self-Efficacy, Setting Characteristics*

	SCSEs Total Score	Personal Social Develop.	Leadership and Assessment	Career Academic Develop.	Collabo- ration	Cultural Awareness
PSC Program Type	NS	NS	NS	NS	NS	NS
School Type	NS	NS	NS	NS	NS	NS
School Agency Type	$\rho = -.088$ $p < .05$	$\rho = -.091$ $p < .05$	NS	$\rho = -.096$ $p < .05$	NS	NS
Title I Status	NS	NS	NS	NS	NS	NS
School Location	NS	NS	NS	NS	NS	NS
Grade Levels Served	$\rho = -.093$ $p < .05$	$\rho = -.208$ $p < .001$	NS	NS	NS	NS

The principal-counselor relationships scale had a statistically significant relationship with self-efficacy ($\rho = .257, p < .001$; 6.6% of the variance explained) and programmatic service delivery ($\rho = -.255, p < .001$; 6.5% of the variance explained) for these data; however, these results had small effect sizes (Cohen, 1988). Work stress had a statistically significant relationship with self-efficacy for these data ($\rho = -.172, p < .001$; 2.9% of the variance explained) and programmatic service delivery for these data ($\rho = -.084, p < .01$; 0.07% of the variance explained); however, these results had small effect sizes (Cohen, 1988). Furthermore, work satisfaction had a statistically significant relationship with overall self-efficacy for these data ($\rho = .297, p < .001$; 8.8% of the variance explained), having small to moderate effect size (Cohen, 1988). In addition, the self-efficacy scale for collaboration was found to have a statistically significant relationship with work satisfaction for these data ($\rho = .318, p < .001$; 10.1% of the variance explained). Unfortunately, limited research is available to compare the results between self-efficacy and job satisfaction of school counselors but these findings identified that higher levels of self-efficacy relate to higher levels of job satisfaction. Perceived job control was found

to have a statistically significant relationship with self-efficacy for these data ($\rho = .283, p < .001$; 8.0% of the variance explained), having small to moderate effect size (Cohen, 1988).

Furthermore, perceived job control had a statistically significant relationship with the collaboration scale on the SCSEs for these data ($\rho = .283, p < .001$; 8.0% of the variance explained). These findings indicate that the higher degree of perceived job control a participant had the more self-efficacy they reported. Unfortunately, no other research was identified that examined school counselors' perceived job control of which to compare these results.

Table 52 *Spearman Rank Order Correlations between Demographics Factors and Self-Efficacy, Other Demographic Information*

	SCSEs Total Score	Personal Social Develop.	Leadership and Assessment	Career Academic Develop.	Collabo- ration	Cultural Awareness
Principal- Counsel Relationship	$\rho = .257$ $p < .001$	$\rho = .225$ $p < .001$	$\rho = .250$ $p < .001$	$\rho = .163$ $p < .001$	$\rho = .273$ $p < .001$	$\rho = .096$ $p < .05$
Work Satisfaction	$\rho = .297$ $p < .001$	$\rho = .271$ $p < .001$	$\rho = .250$ $p < .001$	$\rho = .210$ $p < .001$	$\rho = .318$ $p < .001$	$\rho = .216$ $p < .001$
Work Stress	$\rho = -.172$ $p < .001$	$\rho = -.175$ $p < .001$	$\rho = -.148$ $p < .001$	$\rho = -.171$ $p < .001$	$\rho = -.151$ $p < .001$	$\rho = -.086$ $p < .05$
Perceived Job Control	$\rho = .288$ $p < .001$	$\rho = .244$ $p < .001$	$\rho = .280$ $p < .001$	$\rho = .240$ $p < .001$	$\rho = .304$ $p < .001$	$\rho = .138$ $p < .01$

Exploratory research question two. Is there a statistically significant relationship between practicing schools counselors' service delivery (as measured by the SCARS [Scarborough, 2005]) and their demographic variables (e.g., age, gender, and ethnicity)?

The relationship between school counselors' programmatic service delivery and reported demographic variables was analyzed using Spearman Rank Order correlation (Rho), Krusal-Wallis H test, and Mann-Whitney U tests. This analysis used the entire sample ($N = 690$) and all items from the SCARS. The results from the analyses with significant findings (moderate to high effect size; approximately $> .3$; Cohen, 1988) are discussed here.

Table 53 *Spearman Rank Order Correlations between Demographics Factors and Programmatic Service Delivery, Participant Characteristics*

	SCARS Total Score	Counsel Service Delivery	Consultat Service Delivery	Curricu Service Delivery	Coordina Service Delivery	Other Service Delivery
Gender	NS	NS	NS	NS	NS	NS
Age	NS	$\rho = .101$ $p < .05$	$\rho = .085$ $p < .05$	NS	NS	NS
Ethnicity	$\rho = -.116$ $p < .01$	$\rho = -.126$ $p < .01$	NS	NS	$\rho = -.097$ $p < .05$	$\rho = -.110$ $p < .01$
Years as a SC	$\rho = .084$ $p < .05$	NS	$\rho = .122$ $p < .01$	NS	NS	NS
Years as a Teacher	NS	NS	NS	NS	NS	$\rho = .130$ $p < .01$
Highest Degree Earned	NS	NS	NS	NS	NS	NS
CACREP Graduate	NS	NS	NS	NS	NS	NS
ASCA Membership	$\rho = -.107$ $p < .05$	$\rho = -.196$ $p < .001$	NS	$\rho = -.084$ $p < .05$	$\rho = -.150$ $p < .001$	$\rho = .112$ $p < .01$

Table 54 *Spearman Rank Order Correlations between Demographics Factors and Programmatic Service Delivery, Setting Characteristics*

	SCARS Total Score	Counsel Service Delivery	Consultat Service Delivery	Curricu Service Delivery	Coordina Service Delivery	Other Service Delivery
PSC Program Type	NS	NS	NS	NS	NS	NS
School Type	NS	NS	$\rho = .089$ $p < .05$	NS	NS	NS
School Agency Type	NS	NS	NS	NS	NS	$\rho = -.167$ $p < .001$
Title I Status	NS	NS	NS	$\rho = -.085$ $p < .05$	NS	$\rho = -.104$ $p < .05$
School Location	NS	NS	NS	NS	$\rho = .129$ $p < .01$	NS
Grade Levels Served	$\rho = -.243$ $p < .001$	$\rho = -.192$ $p < .001$	$\rho = -.139$ $p < .001$	$\rho = -.409$ $p < .001$	$\rho = -.091$ $p < .05$	NS

The findings revealed no participant characteristics with moderate to high effect sizes ($> .3$; Cohen, 1988). However, grade levels served had a statistically significant relationship with curriculum activities ($\rho = -.409, p < .01$; 16.7% of the variance explained), which had a moderate effect size (Cohen, 1988). A post hoc Kruskal–Wallis analysis examined the differences in the distribution of mean ranked score for the curriculum (representing classroom guidance) subscale on the SCARS based upon which grade levels are served. The resulting analysis identified that there was a statistical difference ($\chi^2 [6] = 155.469; p < .001; N = 571; \eta^2 = .273$) in the distribution of ranked scores between respondents working in an elementary school ($M_{rank} = 398.08; n = 182$), middle school ($M_{rank} = 265.70; n = 163$), high school ($M_{rank} = 180.94; n = 149$), K-8th grade schools ($M_{rank} = 313.39; n = 14$), 6-12th grade schools ($M_{rank} = 190.64; n = 21$), and K-12th grade schools ($M_{rank} = 309.95; n = 42$). Thus, participants who work in elementary settings reported the most classroom guidance lessons as compared to the other grade levels. Participants in K-8th grade school reported the next highest frequency of classroom guidance activities then K-12th grade schools, middle school, and high school.

These results identifying difference in counselors providing classroom guidance lessons was similar to Rayle and Adams (2007) who found a statistically significant different response ($\chi^2 [2] = 117.66; p < .00; N = 388; \eta^2 = .312$) when investigation elementary school counselors' report of conducting classroom guidance lessons (97.7% of the sample, $n = 130$) as compared to middle school counselors who reported conducting classroom guidance lessons (54.5% of the sample, $n = 54$), and high school counselors who reported conducting classroom guidance lessons (97.4% of the sample, $n = 152$). Furthermore, Scarborough and Culbreth (2008) found a statistically significant effect of school level on the curriculum activities, $F (2, 358) = 39.64, p < .001, \omega^2 = .18$. Their post hoc analysis indicated that elementary school counselors have a higher

likelihood to performed their desired curriculum activities (as indicated by a comparison of difference between actual and preferred tasks; mean difference between actual and desired = .32) as compared to middle (mean difference between actual and desired = .6.91), and mean difference between actual and desired = 1.11).

Table 55 *Spearman Rank Order Correlations between Demographics Factors and Programmatic Service Delivery, Setting Characteristics*

	SCARS Total Score	Counsel Service Delivery	Consultat Service Delivery	Curricu Service Delivery	Coordina Service Delivery	Other Service Delivery
Princip-Counsel Relationship Work Satisfaction Work Stress	$\rho = .255$ $p < .001$	$\rho = .203$ $p < .001$	$\rho = .191$ $p < .001$	$\rho = -.170$ $p < .001$	$\rho = .228$ $p < .001$	NS
Perceived Job Control	$\rho = .246$ $p < .001$	$\rho = .281$ $p < .001$	$\rho = .159$ $p < .001$	$\rho = .188$ $p < .001$	$\rho = .243$ $p < .001$	NS
	$\rho = -.084$ $p < .05$	NS	NS	$\rho = -.088$ $p < .05$	$\rho = -.121$ $p < .01$	NS
	$\rho = .283$ $p < .001$	$\rho = .286$ $p < .001$	$\rho = .167$ $p < .001$	$\rho = .272$ $p < .001$	$\rho = .324$ $p < .001$	$\rho = -.116$ $p < .01$

Work satisfaction was found to have a statistically significant relationship with programmatic service delivery for these data ($\rho = .246, p < .001$; 6.0% of the variance explained), which is consistent with similar studies (e.g., Baggerly & Osborne, 2006; Payne, 2011). Payne (2011) found that providing time for counseling ($r = .50, p < .001$; 25% of the variance explained), building-wide coordination ($r = .42, p < .001$; 17.6% of the variance explained), and classroom guidance ($r = .34, p < .001$; 11.6% of the variance explained) correlated with job satisfaction. The results from this investigation were congruent with previous research findings and these findings support that school counselors who perform more service delivery activities have higher job satisfaction.

Perceived job control was found to have a statistically significant relationship with total score on the SCARS for these data ($\rho = .283, p < .001$; 8.0% of the variance explained), having small to moderate effect size (Cohen, 1988). However, the coordination scale of the SCARS had

a statistically significant relationship with perceived job control with a moderate effect size ($\rho = .324, p < .001$; 10.5% of the variance explained). That is to say, respondents who report higher levels of perceived job control also report higher levels of coordination activities. Unfortunately, there is no research that examines perceived job control and service delivery but this finding provides support for future research.

Exploratory research question three. Is there a statistically significant relationship between practicing schools counselors' professional quality of life (as measured by the *ProQOLs* [Stamm, 2010]) and their demographic variables (e.g., age, gender, and ethnicity)?

The relationship between school counselors' professional quality of life and reported demographic variables was analyzed using Spearman Rank Order correlation (Rho), Kruskal-Wallis H test, and Mann-Whitney U tests. This analysis used the entire sample ($N = 690$) and all items from the ProQOLs. The results for the analyses with significant findings (moderate to high effect size; approximately $> .3$; Cohen, 1988) are discussed here.

Table 56 *Spearman Rank Order Correlations between Demographics Factors and Professional Quality of Life, Participant Characteristics*

	ProQOLs Total Score	Burnout	Compassion Satisfaction	Secondary Traumatic Str.
Gender	$\rho = -.111$ $p < .01$	NS	NS	$\rho = -.083$ $p < .05$
Age	NS	$\rho = -.152$ $p < .001$	$\rho = .142$ $p < .01$	NS
Ethnicity	NS	NS	NS	NS
Years as a SC	NS	NS	NS	NS
Years as a Teacher	NS	NS	NS	$\rho = .090$ $p < .05$
Highest Degree Earned	NS	NS	NS	NS
CACREP Graduate	NS	NS	NS	NS
ASCA Membership	NS	$\rho = .101$ $p < .05$	$\rho = -.147$ $p < .001$	$\rho = .118$ $p < .01$

Table 57 *Spearman Rank Order Correlations between Demographics Factors and Professional Quality of Life, Setting Characteristics*

	ProQOLs Total Score	Burnout	Compassion Satisfaction	Secondary Traumatic Str.
PSC Program Type	NS	NS	NS	NS
School Type	NS	NS	NS	NS
School Agency Type	NS	NS	NS	NS
Title I Status	NS	NS	NS	NS
School Location	NS	$\rho = .134$ $p < .01$	$\rho = -.112$ $p < .01$	NS
Grade Levels Served	NS	NS	NS	NS

The findings identified *no* participant or setting characteristics with moderate to high effect sizes ($> .3$; Cohen, 1988). That is, reported score for the total ProQOLs scale, Burnout, Secondary Traumatic Stress, and Compassion Satisfaction did *not* have any meaningful (moderate to high effects) statistically significant relationships. These findings were consistent

with Limberg’s (2013) study on Burnout and Altruism, which produced correlation coefficient (ρ) for demographic factors ranging from .095 to .198. Research indicates that there are *no* significant relationships between burnout and demographic factors with practicing school counselors.

Table 58 *Spearman Rank Order Correlations between Demographics Factors and Professional Quality of Life, Setting Characteristics*

	ProQOLs Total Score	Burnout	Compassion Satisfaction	Secondary Traumatic Str.
Princip-Counsel Relationship Work Satisfaction	$\rho = -.150$ $p < .001$	$\rho = -.373$ $p < .001$	$\rho = .370$ $p < .001$	$\rho = -.178$ $p < .001$
Work Stress	NS	$\rho = -.498$ $p < .001$	$\rho = .634$ $p < .001$	$\rho = -.150$ $p < .001$
Perceived Job Control	$\rho = .474$ $p < .001$	$\rho = .535$ $p < .001$	$\rho = -.254$ $p < .001$	$\rho = .418$ $p < .001$
	$\rho = -.160$ $p < .001$	$\rho = -.408$ $p < .001$	$\rho = .387$ $p < .001$	$\rho = -.190$ $p < .001$

Principal-counselor relationship was related to both Burnout ($\rho = -.373, p < .001$; 13.9% of the variance explained) and Compassion Satisfaction ($\rho = .370, p < .001$; 13.6% of the variance explained) for these data. These results specify that as respondents reported higher quality relationship with their principal they had lower burnout and increased compassion satisfaction. Limited research has examined the role of principal-counselor relationships on school counselor burnout and compassion satisfaction. However, Clemens and colleagues (2009) found that principal-counselor relationship contributed to school counselor satisfaction (direct effect estimate = 0.55) and turnover intentions (direct effect estimate = -0.36). Therefore, the results in this investigation were similar to Clemens and colleagues (2009) in that a positive relationship between principal and school counselors results in positive affect (as indicated by burnout, compassion satisfaction, job satisfaction, and turnover intentions) towards the job.

Work stress was related to burnout ($\rho = .535, p < .001$; 28.6% of the variance explained) and secondary traumatic stress ($\rho = .418, p < .001$; 17.4% of the variance explained) for these

data. These results indicate that as respondents reported higher levels of work stress their burnout and secondary traumatic stress were higher. The findings were congruent with other studies that examined the relationship between burnout and work stress. For example, Wilkerson (2009) found that participant demographic factors and organizational stressors forecasted school counselors ($N = 198$) emotional exhaustion (a measure of burnout), $F(9, 188) = 12.92, p < .01; R^2 = .38$. Furthermore, (Baggerly & Osborne, 2006) found that higher stress levels in school counselors produced less satisfaction ($r = -.30, p < .01$) and commitment to the job ($r = -.11, p < .05$). Lawson and Meyers (2010) found that wellness (which is suggested to be inversely related to stress; Lazarus & Folkman, 1984; Meyers, Sweeney, & Witmer, 2000) is negatively correlated with both the ProQOLs scales Burnout ($r = -.58, p < .001; r^2 = .34$) and Secondary Traumatic Stress ($r = -.37, p < .001; r^2 = .14$). In agreement with other studies, a higher level of Work Stress has as relationship to burnout and secondary traumatic stress. Moreover, work satisfaction was statistically significant with Burnout ($\rho = -.498, p < .001; 24.8\%$ of the variance explained) and compassion satisfaction ($\rho = .634, p < .001; 40.2\%$ of the variance explained). These findings were congruent with similar studies (Robinson, 2005), supporting that higher job satisfaction relates to decreased burnout and increased compassion satisfaction.

Additionally, perceived job control had a statistically significant relationship with Burnout ($\rho = -.408, p < .001; 16.6\%$ of the variance explained) and Compassion Satisfaction ($\rho = .387, p < .001; 15.0\%$ of the variance explained) for these data. Interesting, as participants indicated higher perceived job control they also had lower reported burnout and high reported compassion satisfaction. Woods (2006) found that when participants reported higher frequency of counseling activities facilitated they also reported higher reported work wellness ($r = .282, p < .001$). Therefore, a logical comparison between Wood's (2009) findings and findings in this

study were similar in that they both identify a positive relationship between completing essential activities (counseling/job control) and job wellbeing (work wellness/burnout/compassion satisfaction).

Exploratory research question four. Is there a statistically significant difference in practicing school counselors' total scores on the SCSEs (Bodenhorn & Skaggs, 2005), ProQOLs (Stamm, 2010), and SCARS (Scarborough, 2005) based upon the (a) sampling method (e.g., email web-based, paper-pencil mail-out survey, face-to-face survey administration), (b) token incentive type (e.g., monetary [\$1.00, \$2.00, or *no* incentive] or non-monetary [\$1.00 donation to the American Red Cross or *no* donation]), and (c) sampling population (e.g., ASCA dataset or Common Core Dataset)?

The relationship between school counselors' professional quality of life and reported demographic variables was analyzed using Kruskal-Wallis H test, Mann-Whitney U tests, and Chi Square test of independence. This analysis used the entire sample including cases with missing items ($N = 735$) and all items from the ProQOLs, SCSEs, and SCARS. The results of the analyses with significant findings (moderate to high effect size; approximately $> .3$; Cohen, 1988; Furguson, 2009) are discussed here

Sampling method. The Kruskal-Wallis analyzes identified a statistically significant difference in the distribution of ranks among the groups of sampling methodologies (e.g., face to face, paper/mail, and internet/email) for the total ProQOLs scores ($\chi^2 [2] = 18.55; p < .001; N = 698; \eta^2 = .027$) and for total SCSEs scores ($\chi^2 [2] = 22.27; p < .001; N = 710; \eta^2 = .031$); however, neither produced results with a significant effect size ($\eta^2 > .04$; Furguson, 2009). Furthermore, the Kruskal-Wallis analysis did *not* identified a statistically significant difference in the distribution of ranks for total SCARS

score among the groups of sampling methodologies ($\chi^2 [2] = 1.095; p = .579; N = 713; \eta^2 = .001$) but did identify a statistically significant difference in the distribution of ranks for total SCARS score (without the Other Activities Items) among the groups of sampling methodologies ($\chi^2 [2] = 18.58; p = .014; N = 713; \eta^2 = .026$). However, the total SCARS score (without the Other Activities Items) still did *not* produce results with a significant effect size ($\eta^2 > .04$; Fergusson, 2009). Therefore, while the results identified a statistically significant difference in total score on the ProQOLs, SCSEs, and SCARS based upon sampling methods, the results do *not* have practical significance based upon how the data was collected (e.g., face-to-face, paper/mail, and internet/email).

Limited published research is available on the difference in respondent score characteristics (e.g., total score average) based upon the method of sampling. Most research regarding sampling method is related to response rate (e.g., Greenlaw & Brown-Welty, 2009; Wolfe, Converse, Airen, & Bodenhorn, 2009; Wolfe, Converse, & Oswald, 2008). Typically, response rate is highest with face-to-face administrations, then paper/mail, and internet/email (e.g., Harris, 2013; Ieva, 2010; Lambie et al., 2011, Limberg, 2013; Wolfe et al., 2009). Based upon an increased response rate, it is often inferred that the quality of the data is more accurate (Dillman et al., 2009). Therefore, the sampling methods with better response rate should return different, more accurate results. The findings in this study indicate that there was a statistically significant difference in total score on the ProQOL, SCSE, and SCARS based on the sampling method group; however, these results had small effect sizes. Therefore, the method of data collection and response rate did *not* influence the school counselors' scores in a significant manner with these data.

Incentive type. The Kruskal-Wallis analysis did *not* identify a statistically significant difference in the distribution of ranks among the groups of paper/mail incentive types (e.g., \$0, \$1, or \$2) for total ProQOLs score ($\chi^2 [2] = 3.741; p = .154; N = 287; \eta^2 = .013$) and for the total SCARS score ($\chi^2 [2] = 1.426; p = .490; N = 290; \eta^2 = .005$). However, the Kruskal-Wallis analysis did identify a statistically significant difference in the distribution of ranks for total SCSEs score among the groups of incentive types ($\chi^2 [2] = 10.212; p = .006; N = 290; \eta^2 = .035$) but it still did *not* produce results with a significant effect size with these data ($\eta^2 > .04$; Furguson, 2009). Therefore, there was no difference in scores based on incentive for the ProQOLs and SCARS. The SCARS did have a statistically significant relationship but the results did *not* have practical significance based upon the incentive type offered to participants who were invited to participate via paper/mail. Based on these findings an inference can be made that the use of incentive in survey research (e.g., \$0, \$1, or \$2 for mail-based and \$0 or \$1 donation for web-based) does *not* impact the score characteristics.

The Mann-Whitney analyses identified that there was *not* a statistical difference ($U = 4184.5; Z = -1.442; p = .149; N = 195; r = .103$) in the distribution of score rankings of ProQOLs total scores between those email/internet-based respondents who received *no* incentive ($M_{rank} = 103.73; n = 99$) and the \$1 donation ($M_{rank} = 92.09; n = 96$). Furthermore, the Mann-Whitney analyses identified that there was *not* a statistical difference ($U = 4828.5; Z = -1.432; p = .152; N = 209; r = .099$) in the distribution of score rankings of SCARS total scores between those email/internet-based respondents who received *no* incentive ($M_{rank} = 99.21; n = 108$) and the \$1 donation ($M_{rank} = 111.19; n = 101$). In addition, the Mann-Whitney analyses identified that there was *not* a

statistical difference ($U = 4606.5$; $Z = -1.846$; $p = .065$; $N = 208$; $r = .128$) in the distribution of score rankings of SCSEs total scores between those email/internet-based respondents who received *no* incentive ($M_{rank} = 96.87$; $n = 105$) and the \$1 donation ($M_{rank} = 112.28$; $n = 103$). Therefore, the incentive type did *not* impact the total mean scores on the ProQOLs, SCSEs, and SCARS for the school counselors who participated in the survey via internet/email. Based on these findings, an inference can be made that incentive type (e.g., \$0, \$1, or \$2 for mail-based and \$0 or \$1 donation for web-based) does *not* influence the mean score for school counselor respondents in survey research.

Limited published research is available on the difference in respondent score characteristics (e.g., total score average) based upon the incentive type. Moreover, there is limited published research on the difference on response rate based upon incentive type. Incentive type is considered the second largest contributor to response rate increase (Dillman et al., 2009) and response rate is considered a contributor to better quality (e.g., more accurate) responses (e.g., Hartman, Fuqua, & Jenkins, 1985). Interestingly, this study did *not* find a statistically significant difference in score characteristics based upon incentive type. That is, respondents' self-reported total scores on the ProQOLs, SCSEs, and SCARS did *not* vary, which may be related to the finding that the response rate based on incentive type was *not* statistically significant. Therefore, an equal response rate of responders based on incentive produced similar results.

Sampling population. The Mann-Whitney U analysis identified that there was *not* a statistical difference ($U = 19353.5$; $Z = -.944$; $p = .345$; $N = 287$; $r = .056$) in the distribution of score rankings of ProQOLs total scores between those mail paper-based respondents who were sampled from the Common Core Dataset ($M_{rank} = 148.48$; $n = 148$)

and ASCA Membership Dataset ($M_{rank} = 139.23$; $n = 139$). Moreover, the Mann-Whitney U analysis identified that there was *not* a statistical difference ($U = 20702$; $Z = -1.574$; $p = .116$; $N = 290$; $r = .092$) in the distribution of score rankings of SCSEs total scores between those mail/paper-based the counselors who were sampled from the Common Core Dataset ($M_{rank} = 138.01$; $n = 150$) and ASCA Membership Dataset ($M_{rank} = 153.52$; $n = 140$). However, the Mann-Whitney U analysis identified that there was a statistical difference ($U = 9019.5$; $Z = -2.076$; $p = .038$; $N = 290$; $r = .121$) in the distribution of score rankings of SCARS total scores between those mail paper based respondents who were sample from the Common Core Dataset ($M_{rank} = 135.63$; $n = 140$) and ASCA Membership Dataset ($M_{rank} = 156.08$; $n = 140$) but did *not* produce results with a significant effect size ($r > .2$; Furguson, 2009). Therefore, the total mean score for the ProQOLs and SCSEs were *not* statistically different as a result of the population from which the participants were sampled. Based on the findings from this study, an inference can be made that the sample used in school counseling research (e.g., ASCA membership versus general population) does *not* influence the mean score average in survey research.

No published research examines the difference in school counselors' self-reported score characteristics (e.g., total score average) based upon the sampled population. This study found inconsistencies in the score characteristics of school counselors based on whether they were selected from the ASCA Membership dataset or the Common Core dataset. The ProQOLs and SCSEs both were *not* statistically significant and the SCARS was statistically significant. However, the SCARS produced a small effect size, which limits its practical significance. Therefore, these results did *not* indicate that the sampling

population differs in their response on these instruments in the data collected for this study.

Exploratory research question five. Is there a statistically significant difference in practicing school counselors' response rate (as measured by completion of the SCSEs, Bodenhorn & Skaggs, 2005; ProQOLs, Stamm, 2010; and SCARS, Scarborough, 2005) based upon the (a) sampling method (e.g., email web-based, paper-pencil mail-out survey, face-to-face survey administration), (b) token incentive type (e.g., monetary [\$1.00, \$2.00, or *no* incentive] or non-monetary [\$1.00 donation to the American Red Cross or *no* donation]), and (c) sampling population (e.g., ASCA Dataset, Common Core Dataset, ASCA Online Directory, or Face to Face)?

Sampling method. Unit nonresponse was statistically significant in relationship to the data collection method (e.g., email web-based, paper-pencil mail-out survey, face-to-face survey administration), Pearson $\chi^2 (2, N = 3,795) = 1331.11, p < .001, \phi = .592$, identifying a moderate to large effect (Pallant, 2010). The proportion of respondents who did *not* complete the *all* instruments (e.g., unit nonresponse) when sampled through face-to-face administration (16.1%) was lower as compared to when participants were sampled by mail/paper (51.5%) and email/internet (93.4%).

This study sought to examine nonresponse because it is suggested that non-response rate leads to non-response bias (e.g., non-response error; Dillman et al., 2009) and nonresponse bias is often overlooked and leads to inaccurate results (Miller & Smith, 1983). Limited research compares all three methods for data collection. However, these results were similar, with an overall lower response rate, as Wolfe, and colleagues (2009) findings. Specifically, Wolfe and colleagues found that mail/paper had five times greater

likelihood of receiving a response as compared to email/internet data collection with school counselors. Wolfe and colleagues used an instrument with 109 items, which is lower than the one in this study, supporting their higher response rate as compared to this study.

Moreover, Greenlaw and Brown-Welty (2009) examined response rate of sampling methods, including: (a) paper based (response rate of 42.03%; $n = 538$), (b) web based (response rate of 52.46%; $n = 672$), or (c) mixed mode (response rate of 60.27%; $n = 772$). Greenlaw and Brown-Welty produced a higher overall response rate as compared to this study; however, their sample included members of the American Evaluation Association, which may have led to better response rates. Also, Greenlaw and Brown-Welty did *not* disclose the number of items on their instrument; therefore, a comparison could not be made.

De Leeuw, Mellenbergh, and Hox (1996) compared response rate of the general public in the Netherlands (not specifically school counselors) based on sampling and obtained a 68% (254) response rate for mail surveys, a 51% (243) response rate for face-to-face surveys, and a 66% (266) response rate for telephone surveys. Again, these results were different from the findings of this study; however, the sample was different and may impact the willingness of participants to respond. Specifically, De Leeuw and colleagues attributed their low face-to-face response rate to the cultural norm of refusing to be a part of surveys found in the Netherlands. Therefore, the findings in this study should be interpreted with caution.

Incentive type. A separate chi square test of independence was conducted to evaluate whether unit nonresponse rate varies depending upon the type of incentive (e.g.,

no incentive, \$1 incentive, or \$2 incentive) used in paper/mail survey administration and internet/email. Unit nonresponse was *not* statistically significant in relationship to the type of incentive used in paper/mail survey administration, Pearson $\chi^2 (2, N = 592) = 5.47, p = .065$. Therefore, there was *no* statistically significant difference in response rate based upon the type of incentive the participants were offered in paper/mail survey administration. Unit nonresponse was *not* statistically significant in relationship to the type of incentive used in email/internet survey administration, Pearson $\chi^2 (1, N = 2966) = .037, p = .847$. Thus, there was *no* statistically significant difference in response rate based upon the type of incentive the school counselors were offered in email/internet survey administration. The findings from this study challenge preexisting theory and research on response rate improvement based on incentive (e.g., Dillman et al., 2009). Specifically, Dillman and colleagues (2009) indicate that incentive is the best way to increase response rate but the findings from this study indicated that there is no difference in response rate for school counselors based on incentive (e.g., paper/mail: no incentive, \$1, or \$2; and internet/email: \$1 paid upon completion or no incentive).

No literature on incentive type exists for survey research with school counselors. Therefore, this is limited of which research to compare these results. Nonetheless, the lack of research on this topic supports the need to explore it. Hawley, Cook, and Jensen-Doss (2009) found that response rate varied based upon incentive type (e.g., no incentive, magnets, and \$1-\$5) amongst mental health practitioners ($n = 494; \chi^2 = 19.19, p < .001$); however, the larger monetary incentive (e.g., \$1, \$2, and \$5) did *not* produce a statically significant difference in response rate for mail-out surveys ($n = 298; \chi^2 = 4.04, p = 0.13$). Hawley and colleagues findings differ from this investigation in that the lower incentive

values statistically significant increase response rate as compare to no incentive.

However, their findings had low practical significant (e.g., $\eta^2 = .04$; Furguson, 2009); therefore, the Hawley and colleagues findings should be interpreted with caution.

Sampling population. A chi square test of independence was conducted to evaluate whether unit nonresponse rate varies depending upon the population sampled for the mail/paper survey administration (e.g., ASCA Dataset, Common Core Dataset, ASCA Online Directory, or Face to Face). Unit nonresponse was statistically significant in relationship to the population sampled, Pearson $\chi^2 (2, N = 3,795) = 1337.80, p < .001, \phi = .594$, identifying a moderate to large effect (Pallant, 2010). The proportion of respondents who did *not* complete *all* instruments (e.g., unit nonresponse) when identified through face-to-face sampling (convenience sampling) was lower (16%) as compared to when participants were identified through the Common Core Dataset (50%), ASCA Dataset (53.1%), and ASCA Online Directory (93.4%).

No research was identified that examined the differences in response rate in school counselors based upon sampling populations. In examination of the findings, it's interesting to note that the samples from the common core dataset and the ASCA membership dataset did not differ much. Considering this is the first time this topic is being examined, there is nothing of which to compare it. However, the findings identified that the sampled populations weresimilar in how the participants responded to the surveys.

Study Limitations

Limitations are inherent in all research (Gall et al., 2007). There are several limitations in this study, including limitations in: (a) research design, (b) sampling methodology, and (c) instrumentation.

Research Design Limitations

Research design limitations concern issues related to the administration of the study. This study was designed with the intent to limit threats related to its design. Correlational research is the process of detecting the direction and magnitude of the relationship between two or more variables using the correlation coefficient (Gall et al., 2007). However, the correlation of two items does *not* represent causality (Stanley & Campbell, 1963). Therefore, this study cannot identify the cause of programmatic service delivery but instead allows the testing of the hypothesized path model based on the data collected from this study. Future studies can build upon the findings from this study to develop studies that examine causality.

An additional limitation is the potential existence of unknown extraneous and confounding variables. Correlational research examines the relationship or correlation between variables (Gall et al., 2007). However, correlational research cannot control for extraneous variables that may be influencing the relationships being tested. Therefore, the results may *not* accurately reflect the phenomenon at hand because there are unforeseen variables. Nonetheless, steps were taken to explore for other factors that may contribute to the relationships being examined. For example, the demographic variables were studied to see if any predominate relationships exist that may account for the results.

Another limitation is the self-report nature of this investigation. Participants freely report they answer to the questions and there is no method to verify their results. Therefore, participants

may respond in a more socially desirable manner. A method that was considered for this study was the use of a social desirability scale (e.g., Strahan, & Gerbasi, 1972). However, the size of the instrument packet was too big and any more questions may have impacted the time it took to complete. Nonetheless, the results from this investigation are similar to other prior research, which supports the acceptability of the respondents' scores.

Sampling Limitations

The goal of sampling procedures is to gain a representative group of participants that allow for generalizability of the results. This investigation utilized both convenient and simple random sampling. The number of participant responses that was random (e.g., ASCA Membership, Common Core Data list, and ASCA Online Directory; $n = 482$) met the needed sample size of 384 to have a 95% confidence level (Krejcie & Morgan, 1970). However, the inclusion of the convenience sample may have impacted the results because these participants were not randomly selected. Further, the initial goal regarding the convenience sample was to obtain three to five school districts in several states to participate. During the recruiting phase of this investigation, eight school districts would *not* allow the study. Therefore, these potential participant voices were never included in the study and only two states (limited geographical diversity) were included. Nevertheless, efforts were made to include a diverse sampling of participants that represented an accurate view of practicing school counselors. The sampling groups were compared and found to have *no* statistically significant difference in response rate or total mean score.

This study used diverse sampling methods. The overall response rate was low (18.19%). However, the low response rate was influenced by the inclusion of email/internet administration that returned a 6.6% response rate. Nonetheless, a limitation is the high degree of nonresponse.

Those participants who chose *not* to complete the study might have a perspective that was *not* included. Nonetheless, the response rate in this study was similar to other studies with practicing school counselors (e.g., Limberg, 2013, Lambie et al., 2011; Mullen, et al., 2014).

An additional sampling limitation includes the ecological validity. Ecological validity relates to the extent to which the results can be generalized based upon the environmental conditions or across settings (Johnson & Christensen, 2004). This study occurred during the fall semester of the traditional school year, which may produce different results than if administered in the spring or summer. Moreover, method and setting that participants completed the setting in may have affected their results. Nevertheless, efforts were made to compare different sampling methods and there was no statistical difference in total mean score. Yet, the response rate was different based on collection method, which may represent the effect of different survey administration settings.

Instrumentation Limitations

This study used three established instruments (e.g., SCSEs [Bodenhorn & Skaggs, 2005], ProQOL [Stamm, 2010], and SCARS [Scarsborough, 2005]) and a researcher created demographics questionnaire. In total, participants were asked to answer 127 items; therefore, the participants may experience test fatigue, resulting in falsely responding to finish the instrument. Also, as noted in chapter four, the attrition rate was greater at later points in the survey. Thus, the length of the instrument may have led to respondents to stop early (e.g., item nonresponse). Nevertheless, the researcher pilot tested the instrumentation packet prior to data collection and it took a reasonable amount of time to complete (approximately 9-18 minutes). However, the length of the packet may contribute to item nonresponse and false participant responses.

The data from this study did *not* fit the theorized measurement models for the instruments (e.g., SCSEs [Bodenhorn & Skaggs, 2005], ProQOL [Stamm, 2010], and SCARS [Scarsborough, 2005]) that were used. Therefore, the data in this study is unique as compared to previous studies that were used to develop the instruments. However, EFA was used to identify the factors there were being measured by the instruments. Then, the factors identified in the EFA were cross-referenced with the content of the items they included to assure the topic was theoretically correct. Consequently, this limitation is accounted for through statistical analysis but the issue of the data *not* fitting the initial instrument structure was still present and worth noting.

Recommendations for Future Research

The results and limitations of this study provide recommendations for future research. The areas of future research include: (a) research on factors that contribute to programmatic service delivery and (b) research on sampling methodology, incentive type, and samples population.

Research on Factors that Contribute to Programmatic Service Delivery

This study is built on the idea that research needs to examine factors that contribute to increased service delivery for school counselors. Future research on the topic of service devliery can build upon these findings to further this topic. Efforts should be made to examine other factors that contribute to service delivery (e.g., school counselor knowledge, systemic barriers, and school counselor desire to complete activities). Furthermore, research on methods to increase the frequency of service in practicing school counselor is needed. For example, researchers can investigate interventions (e.g., trainings or professional development) to educate or support school counselor service delivery activities through outcome based intervention research.

An additional research recommendation would be to examine the quality of programmatic service delivery. To examine the quality of programmatic service delivery, research need to identify a measurement technique to evaluate the effectiveness of the intervention. Then, researchers can investigate what programmatic service delivery activities are the most effective. Future research on the SCARS, ProQOLs, and SCSEs is also need to aid in validating their psychometric properties. Lastly, future research can replicate these findings with the same or similar instruments. Specifically, the ProQOLs had never been used for school counselors and there may be a more appropriate measure of school counselor wellbeing that would produce different results for the theoretical mode tested in this study.

Research on Sampling Methodology, Incentive Type, and Samples Population

This study was only the second investigation found that examined sampling methodology with practicing school counselors. Furthermore, this study was the first to investigate incentive type and sampling populations. Therefore, efforts should be made to examine the way that researchers collect data with school counselors by replicating some of the methods in this study or other methods to investigate this construct. Specifically, future research on the impact of sampling methods (e.g., online, mail, face-to-face), incentive type (\$0, \$1, \$2, or nonmonetary incentives), and the population sampled is needed. The findings in this study necessitate replication with new samples to support or counter the results. In future research, consideration can be given to the size of the instrumentation packet to test if it makes a difference in total score responses. Additionally, future research can examine social desirability amongst school counselors who respond to the different types of data collection methodologies, incentive types, and populations.

Implications

The findings from this investigation contribute to current literature on school counseling. Specifically, the findings from this investigation provide: (a) an increased knowledge of practicing school counselors qualities (e.g., demographic factors) in relationships to self-efficacy and professional quality of life contribute to their programmatic service delivery; (b) an increased understanding of practicing school counselors' programmatic service delivery, self-efficacy, and professional quality of life; and (c) an increased understanding of how practicing school counselors' self-efficacy and professional quality of life contribute to their programmatic service delivery. The implications of this investigation are further discussed.

Implications for Practicing School Counselors

This study sought to enhance the work of school counselors by examining factors (e.g., self-efficacy and professional quality of life) that influence the programmatic service delivery activities. The findings from this investigation highlight factors that contribute to programmatic service delivery. Specifically, self-efficacy accounted for 32.49% (large effect size; standardized coefficient = .57; Cohen, 1988) of the change programmatic service delivery with these data. These results indicate that school counselors with higher self-efficacy contribute more to their school counselor related activities through service delivery. Therefore, school counselors should look to increase their efficacy regarding service delivery tasks. Bandura (1989, 1995, 1997) suggests self-efficacy develops from positive experiences completing a task, vicarious experiences, and social influences (e.g., verbal persuasion, authority figures). Trainings and professional development can be organized in a manner that increases school counselors' self-efficacy. In addition, school counselors should seek positive experiences (e.g., mastery

experiences) with unfamiliar job related tasks through professional development, skill practice, and supervision.

This investigation also identified that school counselors' professional quality of life was related to self-efficacy with 43.56% (large effect size; standardized coefficient = .66; Cohen, 1988) shared variance. Hence, school counselors should be aware of their affective and personal wellbeing because it is related to their self-efficacy. In addition, professional quality of life accounted for 1.00% (small effect size; standardized coefficient = .10; Cohen, 1988) of the change in programmatic service delivery, which gives more merit for school counselors to maintain or increase their wellbeing. Furthermore, the identified relationship between programmatic service delivery and professional quality of life give merit to further research on how school counselors' wellbeing impacts the services school counselors facilitate.

This study utilized the ProQOLs to assess participants' wellbeing, which indicated that school counselors report moderate to low burnout and compassion fatigue and high compassion satisfaction. The ProQOLs is available for free (via www.proqol.org) for practitioners to assess their professional quality of life. The ProQOLs has *not* been normed for school counselors prior to this study. Lawson (2007) and Lawson and Meyers (2011) did use the ProQOLs with small samples of school counselors but these studies held a focus on a more diverse sample of counselors (e.g., mental health, marriage and family therapies). Therefore, school counselors or school districts can utilize the ProQOLs to assess professional quality of life and compare it to the findings from this study with the goal of assessing wellbeing and planning interventions to improve professional quality of life. Interventions to improve wellbeing may include developing a wellness plan, seeking professional development, or securing supervision (Granello, 2012). This study also identified a positive correlation between self-efficacy and professional quality of life.

Thus, interventions that aim to improve school counselors' level of self-efficacy may increase their professional quality of life.

This study utilized the SCSEs to assess participants' self-efficacy, which indicated that school counselors report high levels self-efficacy. The findings indicate that the lowest area of self-efficacy is in leadership and assessment. Therefore, school counselors and school districts should focus attention to promote opportunities for learning and mastery of leadership and assessment. To improve a school counselors self-efficacy regarding leadership and assessment can be facilitated through professional development participation that focuses on providing opportunities for the attendees to rehearse and practice the skills (e.g., mastery experience) under supervision. Furthermore, school districts can take measures to provide resources for school counselors to learn these skills and develop a knowledge base. An additional implication of this investigation is the continued use of the SCSEs provides further data to norm the instrument. School districts can use the SCSEs to assess their school counselors' self-efficacy and promote professional development based upon the results that indicate the areas of lowest self-efficacy.

This investigation utilized the SCARS to examine the frequency of school counselor programmatic service delivery. The findings indicate that school counselors provide a medium to moderate level of activities with consultation being the highest level of service delivery and Other Activities (non-essential duties) being the lowest. School counselors may review to identify common practice in the field with the goal of shaping their school counseling practices and program development. Also, school districts may use the SCARS to examine the frequency of activities in their district and compare the findings found in this study with the goal of informing their policy making. This study adds to existing literature on the SCARS and provides an addition examination of school counselor activities.

Implications for School Counselor Education

This investigation has implications for school counselor education training programs. This study identifies the benefit to increase school counseling trainees' self-efficacy. School counselor education training programs have the resources and opportunities to enact initiatives (e.g., supervision) to support and enhance school counselor trainee's self-efficacy regarding key service delivery tasks. Moreover, the contribution of professional quality of life to self-efficacy and service delivery supports the need for school counseling trainees to have the tools to maintain their wellbeing. As evident in the findings, school counselors reported moderate levels of secondary traumatic stress and burnout. Therefore, preparing school counseling trainees to enter the field with a plan to enhance and maintain wellbeing is important. In addition, this study identifies the need for school counselors to pursue trainings that support their self-efficacy and professional development with the goal of increasing their service delivery.

Specific intervention may be used to address school counselors' self-efficacy and professional quality of life. To support the development of school counseling students' self-efficacy, counselor educators can integrate opportunities for mastery experiences of school counseling tasks (Bandura, 1997). For example, to aid a school counseling trainee to develop efficacy in classroom guidance lessons, counselor educators can create assignments that require students to deliver a guidance lesson to their class. If the students see the experience as successful it may support their confidence to perform classroom guidance lessons in the future when opportunities arise. Similar experiences can be created for other school counseling activities (e.g., develop comprehensive guidance program, consult with parents/teachers/administrators, create an accountability project, and facilitate individual or group counseling). Professional quality of life is an important issue- to support the development of during counselor preparation. Counselor educators can aid students in developing wellness

plan, identifying coping skills, recognizing ways to assess for wellness, and gaining a better theoretical knowledge of wellness (Granello, 2012), all of which can be implemented through a student graduate course work. The goal of training student to be stewards of wellness is so that they will have an increased likelihood of providing effective services to students, as evident in the results of this study.

Implications for School Counseling Researchers

This investigation included an examination of research methodology. School counseling researchers should consider the sampling methodology, incentive type, and sampling population for survey research to make inform decisions about the employed methodology. This study indicates that researchers trying to obtain a high response rate with practicing school counselors should use face-to-face survey administration as compared to paper/mail-based and email/web-based survey. However, the use of face-to-face survey collection does *not* permit random sampling and limits the generalizability of the findings. Furthermore, this study found that paper/mail survey data collection method produced a moderate response rate for practicing school counselors as compared to email/web -based data collection method. The use of paper/mail-based survey affords random sampling and support generalizability. Therefore, researchers should utilize paper/mail if random sampling is a desired trait.

This study did *not* identify a statistically significant difference in total mean score on the ProQOLs, SCSEs, and SCARS based upon sampling method (e.g., email/web, face-to-face, and paper/mail), which indicates that sampling method did *not* influence how participants answered. In addition, the findings indicate that there was *not* a statically significant difference in mean score on the ProQOLs, SCSEs, and SCARS for samples with lower response rate. Therefore, if researchers obtain a low response rate from school counselors, the results may *not* be different

than if they received a high response rate because the findings from this investigation indicate that the score characteristics (e.g., Central Tendency, Normality) may *not* be different. The cost of research is expensive and if there is no difference in the scores based on response rate then it's smart to utilize the more cost efficient methods for data collection.

This study examined the difference in response rate based on incentive types (e.g., \$0, \$1, or \$2 for paper/mail or \$0, or 1\$ donation email/web) for paper/mail-based and email/web-based data collection methods but not the face-to-face administration. Dillman and colleagues (2009) suggest response rate will differ based on the incentive type/value with higher cost incentive returning higher response rate and more accurate results (Dillman et al., 2009). However, the findings from this investigation found the opposite for this data. That is, incentive didn't influence response rate. Furthermore, participant response characteristics did *not* differ based on incentive type used. Therefore, the varied incentive did *not* have an impact. Replication of these findings is necessary to support the validity but the findings from this investigation indicate those researchers do *not* need to use expensive or extensive data collection methods because the results may be similar.

This study examined the difference in mean score and response rate between samples from the general population of school counselors (e.g., Common Core dataset) and a population of counselors in a professional organization (e.g., ASCA Membership dataset). The results indicate that there is *not* a difference in total mean score and response rate. Therefore, researchers can sample either population of practicing school counselor (ASCA members or non-ASCA members) and get similar results.

Implications for the Instrumentation Used in this Investigation

This investigation employed the use of the ProQOLs (Stamm, 2010), SCSEs (Bodenhorn & Skaggs, 2005), and the SCARS (Scarborough, 2005). The ProQOLs was been used in two studies prior to this investigation (e.g., Lawson, 2007; Lawson & Meyers, 2011) and was used in this study to examine school counselors' professional quality of life. Further, the psychometric properties of the ProQOLs have *never* been examined for its use with school counselors. Therefore, this study provides results to guide future use of the ProQOL with school counselors. Specifically, researchers should consider the use of an EFA to identify the correct factor loading of the ProQOLs for school counselors. The data from this study identified a large number (20 items) of items that did *not* contribute to the factors (e.g., subscales), which resulted in their removal. The ProQOLs may *not* be appropriate for use with school counselors considering its emphasis on trauma and in light of its psychometric characteristics from this study. However, the ProQOLs did provide relevant data for this investigation in the form of levels of burnout, compassion satisfaction, and secondary traumatic stress.

This investigation used the SCSEs (Bodenhorn & Skaggs, 2005) to measure school counselors' self-efficacy. The SCSEs was developed using multiple studies (Bodenhorn & Skaggs, 2005). However, since its initial development; limited research was conducted to examine its psychometric properties. This investigation found that the scale on Cultural Awareness Self-Efficacy did *not* identify as an individual factor with these data. Additionally, the data from this study identified a large number of items (31 items) that did *not* contribute to the factors (e.g., subscales), which resulted in their removal. Therefore, future researchers should consider these findings and explore whether this scale fits with their data. Researchers can utilize EFAs to assess the contribution of the data to the theorized factors and remove items that do *not* fit. Nonetheless, the SCSEs is the only school counselor self-efficacy scale available and have

been used across several studies (e.g., Bodenhorn & Skaggs, 2005; Clark, 2006; Wolfe et al., 2010).

This investigation used the SCARS (Scarborough, 2005) to measure school counselor service delivery. Similar to Shillingford and Lambie (2010), this study found the scale regarding Other Activities did *not* identify as an individual factor. In addition, the data from this study identified a large number of items (36 items) that did *not* contribute to the factors (e.g., subscales), which resulted in their removal. Therefore, future researchers should consider this finding and decide whether to include the scale or to further explore its psychometric properties. Nevertheless, the SCARS is a common instrument used to measure the frequency of programmatic service delivery and provided relevant information for this investigation (e.g., Scarborough, 2005; Scarborough & Culbreth, 2008; Shillingford & Lambie, 2010)

Chapter Five Summary

Chapter five reviewed and compared the findings from this investigation with prior research on the topic. The results from this investigation supported the tested hypothesis that school counselors' professional quality of life and their self-efficacy contributed to their service delivery. However, the results should be interpreted with caution given considerations to the limitations of this study. The findings from the exploratory questions in this investigation provide directions for future research considerations on school counselors' self-efficacy, professional quality of life, and programmatic service delivery. Furthermore, findings from the exploratory questions in this investigation guide recommendations for future research on survey methodology. The results and implications from this investigation contribute to the existing research on school counseling and counselor education.

APPENDIX A:
UNIVERSITY OF CENTRAL FLORIDA INSTITUTIONAL REVIEW BOARD APPROVAL
FORM



University of Central Florida Institutional Review Board
Office of Research & Commercialization
12201 Research Parkway, Suite 501
Orlando, Florida 32826-3246
Telephone: 407-823-2901 or 407-882-2276
www.research.ucf.edu/compliance/irb.html

Approval of Exempt Human Research

From: UCF Institutional Review Board #1
FWA00000351, IRB00001138

To: Patrick R. Mullen and Co-PI: Glenn William Lambie

Date: August 12, 2013

Dear Researcher:

On 8/12/2013, the IRB approved the following activity as human participant research that is exempt from regulation:

Type of Review: Exempt Determination
Project Title: The Contribution of School Counselors' Self-Efficacy and Professional Quality of Life to their Programmatic Service Delivery
Investigator: Patrick R. Mullen
IRB Number: SBE-13-09530
Funding Agency:
Grant Title:
Research ID: N/A

This determination applies only to the activities described in the IRB submission and does not apply should any changes be made. If changes are made and there are questions about whether these changes affect the exempt status of the human research, please contact the IRB. When you have completed your research, please submit a Study Closure request in iRIS so that IRB records will be accurate.

In the conduct of this research, you are responsible to follow the requirements of the Investigator Manual.

On behalf of Sophia Dziegielewski, Ph.D., L.C.S.W., UCF IRB Chair, this letter is signed by:

Signature applied by Joanne Muratori on 08/12/2013 09:51:49 AM EDT

A handwritten signature in black ink that reads "Joanne Muratori".

IRB Coordinator

APPENDIX B:
EXPLANATION OF RESEARCH



EXPLANATION OF RESEARCH

Title of Project: The Contribution of School Counselors' Self-Efficacy and Professional Quality of Life to their Programmatic Service Delivery

Principal Investigator: Patrick R. Mullen

Other Investigators: Glenn W. Lambie

Faculty Supervisor: Glenn W. Lambie

Dear School Counselor,

You are being invited to take part in a research study. Whether you participate or not is up to you. The purpose of this research investigation is to explore the contribution of school counselors' self-efficacy and professional quality of life to their programmatic service delivery. The objective is to identify how these constructs relate and contribute to one another.

If you wish to participate, you will complete a set of questions related to your self-efficacy, professional quality of life, and service delivery activities. Additionally, you will be providing some general demographic information. Any information you provide and your participation in this study is *anonymous*.

To complete this questionnaire should take no longer than 15-30 minutes.

You must be 18 years of age or older to take part in this research study.

Your participation in this research project is voluntary. You do not have to participate. You do not have to answer any questions that you do not wish to answer. Please be advised that you may choose not to participate in the study, and may withdraw from the study at any time without consequence.

Study contact for questions about the study or to report a problem:

If you have any questions or comments about this research, please contact Patrick Mullen at (407) 375-0851; pmullen@knights.ucf.edu, University of Central Florida, College of Education, Counselor Education Program, Orlando, FL.

IRB contact about your rights in the study or to report a complaint: Research at the University of Central Florida involving human participants is carried out under the oversight of the Institutional Review Board (UCF IRB). This research has been reviewed and approved by the IRB. For information about the rights of people who take part in research, please contact: Institutional Review Board, University of Central Florida, Office of Research & Commercialization, 12201 Research Parkway, Suite 501, Orlando, FL 32826-3246 or by telephone at (407) 823-2901.

APPENDIX C:
GENERAL DEMOGRAPHICS FORM

General Demographics Questionnaire

Directions: Please complete sections A-Q in the following demographics questionnaire (*all responses are anonymous*)

A. What is your gender? (Mark "X" in the appropriate box):

- Female
 Male
 Other: (please specify) _____

B. What is your age? _____

C. How many years have you worked as a school counselor? _____

D. How many years have you worked as a teacher ("0" indicates no teaching experience)? _____

E. Please indicate what approaches (e.g., school counseling programs) you're currently implementing in your school (Mark "X" in all appropriate boxes)?

- ASCA National Model
 ASCA National Standards
 Comprehensive Guidance and Counseling Program
 Developmental Guidance Program
 Education Trust's Transforming School Counseling Initiative
 No Specified Approach or Program
 State Level Standards or Program
 Other: (please specify) _____

F. What type of school do you currently work in? (Mark "X" in the single most appropriate box):

- Regular (Public, Private, or Charter)
 Alternative Education
 Special Education
 Career Center
 Other: (please specify) _____

G. What is your school agency type (Mark "X" in the single most appropriate box)?

- Public
 Private
 Charter

H. Does your school qualify for Title I (Mark "X" in the single most appropriate box)?

- Yes
 No
 I don't know

I. What is your school location type (Mark "X" in the single most appropriate box)?

- Rural
 Suburban
 Urban

- J. What is your ethnicity (Mark "X" in the appropriate box):**
- African-American
 - Asian-American
 - Hispanic
 - Multiracial
 - Native-American
 - Pacific/Islander
 - White (Non-Hispanic)
 - Other: (please specify) _____
- K. What grade level(s) does your school serve (Mark "X" in the appropriate box)?**
- Elementary
 - Middle/Junior High School
 - High School
 - Other: (please specify) _____
- L. What is the highest degree you have completed to date (Mark "X" in the appropriate box)?**
- Bachelors
 - Masters
 - Educational Specialist
 - Doctorate of Philosophy (Ph.D.)
 - Doctorate of Education (Ed.D.)
 - Other: (please specify) _____
- M. Did you receive your school counseling degree from a CACREP-accredited program? (Mark "X" in the appropriate box)**
- Yes
 - No
 - I don't know
- N. Are you a member of the American School Counselor Association? (Mark "X" in the appropriate box)**
- Yes
 - No
- O. If you are not a current member of the American School Counselor Association, have you been a member within the past five years? (Mark "X" in the appropriate box)**
- No
 - Yes
- P. If you are not a current member of the American School Counselor Association, please select the best reasons as to why (Mark "X" in all appropriate boxes):**
- Cost too much/cannot afford it
 - Not worth it/limited benefit(s)
 - I am a member of another organization
 - I have never heard of ASCA
 - Other: (please specify) _____

Q. Please answer the following questions to the best of your ability:

Read the three statements below. Then, please circle the number that best represents the most accurate response.

Scoring Values:

1= Strongly disagree, 2=Disagree, 3= Neither disagree or agree,4=Agree, 5= Strongly Agree

	Strongly disagree	Disagree	Neither agree or disagree	Agree	Strongly Agree
1. My current principal respects my opinion on important school related issues.	1	2	3	4	5
2. All in all, I enjoy working as a school counselor with my current principal.	1	2	3	4	5
3. My current principal recognizes the importance of my work as a school counselor.	1	2	3	4	5
4. I enjoy my work as a school counselor.	1	2	3	4	5
5. My work as a school counselor continues to challenge me.	1	2	3	4	5
6. If I could go back in time, I would choose the same career as a school counselor.	1	2	3	4	5
7. I feel stressed while working as a school counselor.	1	2	3	4	5
8. I think about my work as a school counselor while I am at home.	1	2	3	4	5
9. I lose sleep as the result of my work as a school counselor.	1	2	3	4	5
10. I decide on what I do at work on a daily basis as a school counselor.	1	2	3	4	5
11. I have the ability to deliver the services I think are most important for students and families as a school counselor.	1	2	3	4	5
12. Other people have control over what I do on a daily basis as a school counselor.	1	2	3	4	5

Please provide any general comments you have regarding this overall research investigation:

Thank you for your participation!

APPENDIX D:
SCHOOL COUNSELOR SELF-EFFICACY SCALE

School Counselor Self-Efficacy Scale (SCSE; Bodenhorn & Skaggs, 2005)

Below is a list of activities representing many school counselor responsibilities. Indicate your confidence in your current ability to perform each activity by circling the appropriate answer next to each item according to the scale defined below. Please answer each item based on one current school, and based on how you feel now, not on your anticipated (or previous) ability or school(s). Remember, this is not a test and there are no right answers.

Please circle the number that best represents your response for each item.

	Not Confident	Slightly Confident	Moderately Confident	Generally Confident	Highly Confident
1. Advocate for integration of student academic, career, and personal development into the mission of my school.	1	2	3	4	5
2. Recognize situations that impact (both negatively and positively) student learning and achievement.	1	2	3	4	5
3. Analyze data to identify patterns of achievement and behavior that contribute to school success.	1	2	3	4	5
4. Advocate for myself as a professional school counselor and articulate the purposes and goals of school counseling.	1	2	3	4	5
5. Develop measurable outcomes for a school counseling program which would demonstrate accountability.	1	2	3	4	5
6. Consult and collaborate with teachers, staff, administrators and parents to promote student success.	1	2	3	4	5
7. Establish rapport with a student for individual counseling.	1	2	3	4	5
8. Function successfully as a small group leader.	1	2	3	4	5
9. Effectively deliver suitable parts of the school counseling program through large group meetings such as in classrooms.	1	2	3	4	5
10. Conduct interventions with parents, guardians and families in order to resolve problems that impact students' effectiveness and success.	1	2	3	4	5
11. Teach students how to apply time and task management skills.	1	2	3	4	5
12. Foster understanding of the relationship between learning and work.	1	2	3	4	5
13. Offer appropriate explanations to students, parents and teachers of how learning styles affect school performance.	1	2	3	4	5
14. Deliver age-appropriate programs through which students acquire the skills needed to investigate the world of work.	1	2	3	4	5
15. Implement a program which enables all students to make informed career decisions.	1	2	3	4	5
16. Teach students to apply problem-solving skills toward their academic, personal and career success.	1	2	3	4	5
17. Evaluate commercially prepared material designed for school counseling to establish their relevance to my school population.	1	2	3	4	5
18. Model and teach conflict resolution skills.	1	2	3	4	5
19. Ensure a safe environment for all students in my school.	1	2	3	4	5
20. Change situations in which an individual or group treats others in a disrespectful or harassing manner.	1	2	3	4	5
21. Teach students to use effective communication skills with peers, faculty, employers, family, etc.	1	2	3	4	5

School Counselor Self-Efficacy Scale (SCSE; Bodenhorn & Skaggs, 2005)

Below is a list of activities representing many school counselor responsibilities. Indicate your confidence in your current ability to perform each activity by circling the appropriate answer next to each item according to the scale defined below. Please answer each item based on one current school, and based on how you feel now, not on your anticipated (or previous) ability or school(s). Remember, this is not a test and there are no right answers.

Please circle the number that best represents your response for each item.

	Not Confident	Slightly Confident	Moderately Confident	Generally Confident	Highly Confident
22. Follow ethical and legal obligations designed for school counselors.	1	2	3	4	5
23. Guide students in techniques to cope with peer pressure.	1	2	3	4	5
24. Adjust my communication style appropriately to the age and developmental levels of various students.	1	2	3	4	5
25. Incorporate students' developmental stages in establishing and conducting the school counseling program.	1	2	3	4	5
26. I can find some way of connecting and communicating with any student in my school.	1	2	3	4	5
27. Teach, develop and/or support students' coping mechanisms for dealing with crises in their lives – e.g., peer suicide, parent's death, abuse, etc.	1	2	3	4	5
28. Counsel effectively with students and families from different social/economic statuses.	1	2	3	4	5
29. Understand the viewpoints and experiences of students and parents who are from a different cultural background than myself.	1	2	3	4	5
30. Help teachers improve their effectiveness with students.	1	2	3	4	5
31. Discuss issues of sexuality and sexual orientation in an age appropriate manner with students.	1	2	3	4	5
32. Speak in front of large groups such as faculty or parent meetings.	1	2	3	4	5
33. Use technology designed to support student successes and progress through the educational process.	1	2	3	4	5
34. Communicate in writing with staff, parents, and the external community.	1	2	3	4	5
35. Help students identify and attain attitudes, behaviors, and skills which lead to successful learning.	1	2	3	4	5
36. Select and implement applicable strategies to assess school-wide issues.	1	2	3	4	5
37. Promote the use of counseling and guidance activities by the total school community to enhance a positive school climate.	1	2	3	4	5
38. Develop school improvement plans based on interpreting school-wide assessment results.	1	2	3	4	5
39. Identify aptitude, achievement, interest, values, and personality appraisal resources appropriate for specified situations and populations.	1	2	3	4	5
40. Implement a preventive approach to student problems.	1	2	3	4	5
41. Lead school-wide initiatives which focus on ensuring a positive learning environment.	1	2	3	4	5
42. Consult with external community agencies which provide support services for our students.	1	2	3	4	5
43. Provide resources and guidance to school population in times of crisis.	1	2	3	4	5

APPENDIX E:
SCHOOL COUNSELOR ACTIVITY RATINGS SCALE

School Counseling Activity Rating Scale (SCARS; Scarborough, 2005)

Below is a list of functions that may be performed by school counselors.
Please CIRCLE the number that indicates the frequency with which you ACTUALLY perform each function.

	<u>I never do this</u>	<u>I rarely do this</u>	<u>I occasionally do this</u>	<u>I frequently do this</u>	<u>I routinely do this</u>
1. Counsel with students regarding personal/family concerns	1	2	3	4	5
2. Counsel with students regarding school behavior	1	2	3	4	5
3. Counsel students regarding crisis/emergency issues	1	2	3	4	5
4. Counsel with students regarding relationships (e.g., family, friends, romantic)	1	2	3	4	5
5. Provide small group counseling addressing relationship/social skills	1	2	3	4	5
6. Provide small group counseling for academic issues	1	2	3	4	5
7. Conduct small groups regarding family/personal issues (e.g., divorce, death)	1	2	3	4	5
8. Conduct small group counseling for students regarding substance abuse issues (own use or family/friend use)	1	2	3	4	5
9. Follow-up on individual and group counseling participants	1	2	3	4	5
10. Counsel students regarding academic issues	1	2	3	4	5
11. Consult with school staff concerning student behavior	1	2	3	4	5
12. Consult with community and school agencies concerning individual students	1	2	3	4	5
13. Consult with parents regarding child/adolescent development issues	1	2	3	4	5
14. Coordinate referrals for students and/or families to community or education professionals (e.g., mental health, speech pathology, medical assessment)	1	2	3	4	5
15. Assist in identifying exceptional children (special education)	1	2	3	4	5
16. Provide consultation for administrators (regarding school policy, programs, staff and/or students)	1	2	3	4	5
17. Participate in team / grade level / subject team meetings	1	2	3	4	5
18. Conduct classroom activities to introduce yourself and explain the counseling program to all students	1	2	3	4	5
19. Conduct classroom lessons addressing career development and the world of work	1	2	3	4	5
20. Conduct classroom lessons on various personal and/ or social traits (e.g., responsibility, respect, etc.)	1	2	3	4	5
21. Conduct classroom lessons on relating to others (family, friends)	1	2	3	4	5
22. Conduct classroom lessons on personal growth and development issues	1	2	3	4	5
23. Conduct classroom lessons on conflict resolution	1	2	3	4	5

School Counseling Activity Rating Scale (SCARS; Scarborough, 2005)

Below is a list of functions that may be performed by school counselors.
Please CIRCLE the number that indicates the frequency with which you ACTUALLY perform each function.

	<u>I never do this</u>	<u>I rarely do this</u>	<u>I occasionally do this</u>	<u>I frequently do this</u>	<u>I routinely do this</u>
24. Conduct classroom lessons regarding substance abuse	1	2	3	4	5
25. Conduct classroom lessons on personal safety issues	1	2	3	4	5
26. Coordinate special events and programs for school around academic, career, or personal/social issues (e.g., career day, drug awareness week, test prep)	1	2	3	4	5
27. Coordinate and maintain a comprehensive school counseling program	1	2	3	4	5
28. Inform parents about the role, training, program, and interventions of a school counselor within the context of your school	1	2	3	4	5
29. Conduct or coordinate parent education classes or workshops	1	2	3	4	5
30. Coordinate school-wide response for crisis management and intervention	1	2	3	4	5
31. Inform teachers / administrators about the role, training, program, and interventions of a school counselor within the context of your school.	1	2	3	4	5
32. Conduct or coordinate teacher in-service programs	1	2	3	4	5
33. Keep track of how time is being spent on the functions that you perform	1	2	3	4	5
34. Attend professional development activities (e.g., state conferences, local in-services)	1	2	3	4	5
35. Coordinate with an advisory team to analyze and respond to school counseling program needs	1	2	3	4	5
36. Formally evaluate student progress as a result of participation in individual/group counseling from student, teacher and/or parent perspectives	1	2	3	4	5
37. Conduct needs assessments and counseling program evaluations from parents, faculty and/or students	1	2	3	4	5
38. Coordinate orientation process / activities for students	1	2	3	4	5
39. Participate on committees within the school	1	2	3	4	5
40. Coordinate the standardized testing program	1	2	3	4	5
41. Organize outreach to low income families (i.e., Thanksgiving dinners, Holiday families)	1	2	3	4	5
42. Respond to health issues (e.g., check for lice, eye screening, 504 coordination)	1	2	3	4	5
43. Perform hall, bus, cafeteria duty	1	2	3	4	5
44. Schedule students for classes	1	2	3	4	5
45. Enroll students in and/or withdraw students from school	1	2	3	4	5
46. Maintain/Complete educational records/reports (cumulative files, test scores, attendance reports, drop-out reports)	1	2	3	4	5
47. Handle discipline of students	1	2	3	4	5
48. Substitute teach and / or cover classes for teachers at your school	1	2	3	4	5

APPENDIX F:
PROFESSIONAL QUALITY OF LIFE SCALE

Professional Quality of Life Scale (ProQOL; Stamm, 2010)

When you [help] people you have direct contact with their lives. As you may have found, your compassion for those you [help] can affect you in positive and negative ways. Below are some questions about your experiences, both positive and negative, as a [helper]. Consider each of the following questions about you and your current work situation. Select the number that honestly reflects how frequently you experienced these things in the last 30 days.

	Never	Rarely	Sometimes	Often	Very Often
1. I am happy.	1	2	3	4	5
2. I am preoccupied with more than one person I [help].	1	2	3	4	5
3. I get satisfaction from being able to [help] people.	1	2	3	4	5
4. I feel connected to others.	1	2	3	4	5
5. I jump or am startled by unexpected sounds.	1	2	3	4	5
6. I feel invigorated after working with those I [help].	1	2	3	4	5
7. I find it difficult to separate my personal life from my life as a [helper].	1	2	3	4	5
8. I am not as productive at work because I am losing sleep over traumatic experiences of a person I [help].	1	2	3	4	5
9. I think that I might have been affected by the traumatic stress of those I [help].	1	2	3	4	5
10. I feel trapped by my job as a [helper].	1	2	3	4	5
11. Because of my [helping], I have felt "on edge" about various things.	1	2	3	4	5
12. I like my work as a [helper].	1	2	3	4	5
13. I feel depressed because of the traumatic experiences of the people I [help].	1	2	3	4	5
14. I feel as though I am experiencing the trauma of someone I have [helped].	1	2	3	4	5
15. I have beliefs that sustain me.	1	2	3	4	5
16. I am pleased with how I am able to keep up with [helping] techniques and protocols.	1	2	3	4	5
17. I am the person I always wanted to be.	1	2	3	4	5
18. My work makes me feel satisfied.	1	2	3	4	5
19. I feel worn out because of my work as a [helper].	1	2	3	4	5
20. I have happy thoughts and feelings about those I [help] and how I could help them.	1	2	3	4	5
21. I feel overwhelmed because my case [work] load seems endless.	1	2	3	4	5
22. I believe I can make a difference through my work.	1	2	3	4	5
23. I avoid certain activities or situations because they remind me of frightening experiences of the people I [help].	1	2	3	4	5
24. I am proud of what I can do to [help].	1	2	3	4	5
25. As a result of my [helping], I have intrusive, frightening thoughts.	1	2	3	4	5
26. I feel "bogged down" by the system.	1	2	3	4	5
27. I have thoughts that I am a "success" as a [helper].	1	2	3	4	5
28. I can't recall important parts of my work with trauma victims.	1	2	3	4	5
29. I am a very caring person.	1	2	3	4	5
30. I am happy that I chose to do this work.	1	2	3	4	5

APPENDIX G:
RECRUITMENT EMAIL FOR ASCA ONLINE MEMBERSHIP DIRECTORY – NO
INCENTIVE

From: Patrick R. Mullen [pmullen@knights.ucf.edu] (through Qualtics)
To: recipient

Subject: Initial Request for Participation in a Research

[DATE]

Dear School Counselor:

I am writing to request your assistance with a significant study being conducted at the University of Central Florida to understand the contribution of school counselors' self-efficacy and professional quality of life to their programmatic service delivery.

This study aims to develop an accurate understanding of these unique constructs and their relationships. Therefore, I need to survey a diverse set of practicing school counselors to get their input. Your address was randomly selected to help in this study from ASCA's online membership directory. As a practicing school counselor and member of ASCA, you were selected as a potential participant for this investigation.

Your participation in responses to this survey is very important and will help contribute to a growing body of research on factors that influence programmatic service delivery. As a part of this study, I am looking for your individual responses to the three instruments and demographics form. Your input is an integral part of this research.

This is a short questionnaire and should take you 15 to 30 minutes to complete. Please click the link below to go to the survey website (or copy and paste the survey link into your internet browser) and then enter the personal access code to begin the survey.

Survey Link: [XXXX]

Personal Access Code: [XXXX]

Your participation in this survey is voluntary and all of your responses will be anonymous.

The access code is used to remove you from the list once you have completed the survey. No personally identifiable information will be associated with your responses in any reports of this data. Should you have any questions or comments, please feel free to contact me at pmullen@knights.ucf.edu or 407-375-0851. This study has been reviewed and approved by the University of Central Florida Institutional Review Board, and if you have any questions about your rights as a participant in this study, you may contact them by telephone at 407-823-3778.

I appreciate your time and consideration in completing the survey. It is only through the help of participants like you that I can provide information to help guide the development of research regarding the counseling profession.

Many Thanks!

Patrick R. Mullen

Principal Investigator
University of Central Florida
College of Education
4000 Central Florida Blvd.
Orlando, FL 32816

APPENDIX H:
REMINDER EMAIL FOR ASCA ONLINE MEMBERSHIP DIRECTORY – NO INCENTIVE

From: Patrick R. Mullen [pmullen@knights.ucf.edu] (through Qualtrics)
To: recipient

Subject: Research Survey on School Counselor Service Delivery

[DATE]

Dear School Counselor:

We recently asked for your participation in a survey that we are conducting with practicing school counselors. We are asking participants to complete a set of online questionnaires concerning school counselors' self-efficacy, professional quality of life, and programmatic service delivery.

This is a short set of questionnaires and should take you 15-30 minutes to complete. **If you have already completed this survey, we appreciate your participation!** If you have not responded to this survey, we encourage you to take a few minutes and complete the survey.

Don't forget, for every completed survey I will donate a dollar to the American Red Cross Association.

Please click the link below to go to the survey website (or copy and paste the survey link into your internet browser) and then enter the personal access code to begin the survey.

Survey Link: [XXXX]

Personal Access Code: [XXXX]

Your response is important and your answers are anonymous. Getting direct input from practicing counselors regarding this topic will help guide the development of research on this topic. Thank you for your assistance in this study!

Much Appreciation,

Patrick R. Mullen
Principal Investigator
University of Central Florida
College of Education
4000 Central Florida Blvd.
Orlando, FL, 32816

APPENDIX I:
FINAL REMINDER EMAIL FOR ASCA ONLINE MEMBERSHIP DIRECTORY – NO
INCENTIVE

From: Patrick R. Mullen [pmullen@knights.ucf.edu] (through Qualtrics)
To: recipient

Subject: Final Request for your Response to a Research Investigation

[DATE]

Dear School Counselor:

This time of the year can be a busy time and I understand how valuable your time is. I am hoping you may be able to give about 20 minutes of your time to help us collect information pertaining to school counselor self-efficacy, professional quality of life, and programmatic service delivery.

If you have already completed this survey, I really appreciate your participation. If you have not yet responded, I would like to urge you to complete the questionnaires.

I plan to end this study soon, so I wanted to email all potential participants who have not responded to make sure they had a chance to contribute.

Please click the link below to go to the survey website (or copy and paste the survey link into your internet browser) and then enter the personal access code to begin the survey.

Survey Link: [XXXX]

Personal Access Code: [XXXX]

Thank you in advance for completing this survey. *Your response is important and anonymous.* Practicing counselors are the best source of responses when seeking research.

Sincerely,

Patrick R. Mullen
Principal Investigator
University of Central Florida
College of Education
4000 Central Florida Blvd.
Orlando, FL, 32816

APPENDIX J:
RECRUITMENT EMAIL FOR ASCA ONLINE MEMBERSHIP DIRECTORY – WITH
INCENTIVE

From: Patrick R. Mullen [pmullen@knights.ucf.edu] (through Qualtics)
To: recipient

Subject: Initial Request for Participation in a Research

[DATE]

Dear School Counselor:

I am writing to request your assistance with a significant study being conducted at the University of Central Florida to understand the contribution of school counselors' self-efficacy and professional quality of life to their programmatic service delivery.

This study aims to develop an accurate understanding of these unique constructs and their relationships. Therefore, I need to survey a diverse set of practicing school counselors to get their input. Your address was randomly selected to help in this study from ASCA's online membership directory. As a practicing school counselor and member of ASCA, you were selected as a potential participant for this investigation.

Your participation in responses to this survey is very important and will help contribute to a growing body of research on factors that influence programmatic service delivery. As a part of this study, I am looking for your individual responses to the three instruments and demographics form. Your input is an integral part of this research.

Additionally, as a sign of appreciation, for every completed survey, I will donate one dollar to the American Red Cross Association.

This is a short questionnaire and should take you 15 to 30 minutes to complete. Please click the link below to go to the survey website (or copy and paste the survey link into your internet browser) and then enter the personal access code to begin the survey.

Survey Link: [XXXX]

Personal Access Code: [XXXX]

Your participation in this survey is voluntary and all of your responses will be anonymous.

The access code is used to remove you from the list once you have completed the survey. No personally identifiable information will be associated with your responses in any reports of this data. Should you have any questions or comments, please feel free to contact me at pmullen@knights.ucf.edu or 407-375-0851. This study has been reviewed and approved by the University of Central Florida Institutional Review Board, and if you have any questions about your rights as a participant in this study, you may contact them by telephone at 407-823-3778.

I appreciate your time and consideration in completing the survey. It is only through the help of participants like you that I can provide information to help guide the development of research regarding the counseling profession.

Many Thanks!

Patrick R. Mullen
Principal Investigator
University of Central Florida
College of Education
4000 Central Florida Blvd.
Orlando, FL 32816

APPENDIX K:
REMINDER EMAIL FOR ASCA ONLINE MEMBERSHIP DIRECTORY – WITH
INCENTIVE

From: Patrick R. Mullen [pmullen@knights.ucf.edu] (through Qualtics)
To: recipient

Subject: Research Survey on School Counselor Service Delivery

[DATE]

Dear School Counselor:

We recently asked for your participation in a survey that we are conducting with practicing school counselors. We are asking participants to complete a set of online questionnaires concerning school counselors' self-efficacy, professional quality of life, and programmatic service delivery.

This is a short set of questionnaires and should take you 15-30 minutes to complete. **If you have already completed this survey, we appreciate your participation!** If you have not responded to this survey, we encourage you to take a few minutes and complete the survey.

Don't forget, for every completed survey I will donate a dollar to the American Red Cross Association.

Please click the link below to go to the survey website (or copy and paste the survey link into your internet browser) and then enter the personal access code to begin the survey.

Survey Link: [XXXX]

Personal Access Code: [XXXX]

Your response is important and your answers are anonymous. Getting direct input from practicing counselors regarding this topic will help guide the development of research on this topic. Thank you for your assistance in this study!

Much Appreciation,

Patrick R. Mullen
Principal Investigator
University of Central Florida
College of Education
4000 Central Florida Blvd.
Orlando, FL, 32816

APPENDIX L:
FINAL REMINDER EMAIL FOR ASCA ONLINE MEMBERSHIP DIRECTORY – WITH
INCENTIVE

From: Patrick R. Mullen [pmullen@knights.ucf.edu] (through Qualtics)
To: recipient

Subject: Final Request for your Response to a Research Investigation

[DATE]

Dear School Counselor:

This time of the year can be a busy time and I understand how valuable your time is. I am hoping you may be able to give about 20 minutes or your time to help us collect information pertaining to school counselor self-efficacy, professional quality of life, and programmatic service delivery.

If you have already completed this survey, I really appreciate your participation. If you have not yet responded, I would like to urge you to complete the questionnaires.

I plan to end this study soon, so I wanted to email all potential participants who have not responded to make sure they had a chance to contribute.

Also, I am making a dollar donation to the American Red Cross Association for every survey completed.

Please click the link below to go to the survey website (or copy and paste the survey link into your internet browser) and then enter the personal access code to begin the survey.

Survey Link: [XXXX]

Personal Access Code: [XXXX]

Thank you in advance for completing this survey. ***Your response is important and anonymous.*** Practicing counselors are the best source of responses when seeking research.

Sincerely,

Patrick R. Mullen
Principal Investigator
University of Central Florida
College of Education
4000 Central Florida Blvd.
Orlando, FL, 32816

APPENDIX M:
RECRUITMENT LETTER FOR PAPER/MAIL SURVEY – NO INCENTIVE

[Date]

[Address 1]

[Address 2]

[Address 3]

Dear [Name],

I am writing to request your assistance with a significant study being conducted at the University of Central Florida to understand the contribution of school counselors' self-efficacy and professional quality of life to their programmatic service delivery. This study aims to develop an accurate understanding of these unique constructs and their relationships. Therefore, I need to survey a diverse set of practicing school counselors to get their input. Your address was randomly selected to help in this study from a national database of potential school counselor participants.

Your responses are important to this study and its accuracy.

Please take a moment and complete the enclosed instrument packet. We have included a return envelop with stamp for your convenience. In addition, you can complete this set of instruments via an online survey portal at www.counselorsurvey.us. Your personalized access code is: [XXXX].

The instrument packet should only take about 15-30 minutes to complete in either format. Your responses are voluntary and will be kept confidential. Your names and mailing address will never be associated with your responses.

If you have any questions about this survey, please call the Principal Investigator, Patrick R. Mullen at 407-375-0851, or by email at pmullen@knights.ucf.edu. This study has been reviewed and approved by the University of Central Florida Institutional Review Board, and if you have any questions about your rights as a participant in this study you may contact them by telephone at 407-823-3778.

We hope you enjoy completing the instrument packet and look forward to receiving your responses.

Much appreciated,

Patrick R. Mullen
Principal Investigator

APPENDIX N:
RECRUITMENT LETTER FOR PAPER/MAIL SURVEY – WITH INCENTIVE

[Date]

[Address 1]

[Address 2]

[Address 3]

Dear [Name],

I am writing to request your assistance with a significant study being conducted at the University of Central Florida to understand the contribution of school counselors' self-efficacy and professional quality of life to their programmatic service delivery. This study aims to develop an accurate understanding of these unique constructs and their relationships. Therefore, we need to survey a diverse set of practicing school counselors to get their input. Your address was randomly selected to help in this study from a national database of potential school counselor participants.

Your responses are important to this study and its accuracy.

Please take a moment and complete the enclosed instrument packet. We have included a return envelop with stamp for your convenience. In addition, you can complete this set of instruments via an online survey portal at www.counselorsurvey.us. Your personalized access code is: [XXXX].

The instrument packet should only take about 15-30 minutes to complete in either format. Your responses are voluntary and will be kept confidential. Your names and mailing address will never be associated with your mailing address.

If you have any questions about this survey, please call the Primary Research Investigator, Patrick R. Mullen at 407-375-0851, or by email at pmullen@knights.ucf.edu. This study has been reviewed and approved by the University of Central Florida Institutional Review Board, and if you have any questions about your rights as a participant in this study you may contact them by telephone at 407-823-3778.

By taking a few minutes to complete this packet you are willing to help us out a great deal. Therefore, a small token of appreciation is enclosed. This is our way of saying thank you.

We hope you enjoy completing the instrument packet and look forward to receiving your responses.

Much appreciated,

Patrick R. Mullen
Primary Research Investigator

APPENDIX O:
POSTCARD REMINDER FOR PAPER/MAIL SURVEY

Thank you for participating

Recently, an instrument packet was mailed to you because you were randomly selected to answer some questions about your work as a school counselor.

If you have completed this instrument packet, please take this as our sincere thanks. If not, please consider completing and return the questionnaire packet. We are especially grateful for your help in this matter.

If you did not receive an instrument packet, or it was misplaced, please call me at 407-375-0851 and we will get another one in the mail today.

Sincerely,

Patrick R. Mullen
Principal Investigator



Patrick R. Mullen
University of Central Florida
4000 Central Florida Blvd.
UCF teaching Academy, #420
PO Box 161250
Orlando, FL 32816-1250



APPENDIX P:
REPLACEMENT PACKET REMINDER LETTER FOR PAPER/MAIL SURVEY

[Date]

[Address 1]

[Address 2]

[Address 3]

Dear [Name],

In early September, I sent a letter to your address that requested you to complete a questionnaire regarding the constructs of self-efficacy, professional quality of life, and programmatic service delivery. From what I can tell, it has yet to be sent back.

We are writing because it is of the utmost importance that you have the opportunity to provide input because it helps us get the most accurate and appropriate results. It is only by hearing from nearly everyone in the sample that I can be sure that the results truly represent the constructs I am measuring. Therefore, I hope that you will complete the packet soon.

We have included a new packet with the questionnaires and a stamped, return envelope. You may also complete the packet online by visiting www.counselorsurvey.us and typing in your personal access code: [XXXX].

As mentioned before, the questions should only take about 15-30 minutes to complete. Your responses are voluntary and are anonymous. Your answers will never be associated with your name. If you have any questions about this survey, the principle investigator, Patrick R. Mullen, would be happy to speak with you by email: pmullen@knights.ucf.edu or phone: 407-375-0851. This study has been reviewed and approved by the University of Central Florida Institutional Review Board, and if you have any questions about your rights as a participant in this study you may contact them by telephone at 407-823-3778.

We hope that you enjoy the questionnaire.

Best wishes,

Patrick R. Mullen

APPENDIX Q:
FINAL REMINDER LETTER FOR PAPER/MAIL SURVEY

[Date]

[Address 1]

[Address 2]

[Address 3]

Dear [Name],

In September, a letter and instrument packet was sent to your address that invited you to complete a instrumentation packet regarding the constructs of self-efficacy, professional quality of life, and programmatic service delivery. As of yet, I have not received a complete instrumentation packet.

We are writing for the last time because I hope you know how important your responses are to our study. To have an accurate voice, I am pursuing your perspective in this study. Therefore, I hope that you will consider completing the instruments in this packet.

You can complete the instruments by completing and returning the paper version of the packet previous mailed to you or by going online to www.counselorsurvey.us and entering you personal access code: [XXXX].

As I have said, the questions are brief, about 15 to 30 minutes to complete. All responses are voluntary and are anonymous. Your answers will never be associated with you in any way.

If you have any questions about this study, Patrick R. Mullen the primary investigator, would be happy to speak with you by email: pmullen@knights.ucf.edu or phone: 407-375-0851. This study has been reviewed and approved by the University of Central Florida Institutional Review Board, and if you have any questions about your rights as a participant in this study you may contact them by telephone at 407-823-3778.

It is our hope that you find this exercise worthwhile and rewarding.

Kind regards,

Patrick R. Mullen

APPENDIX R:
WEBSITE PERMISSION TO USE THE PROQOLS

ProQOL Measure

www.proqol.org/ProQol_Test.html

Reload current page

compassion satisfaction, burnout and compassion fatigue.

The measure has been in use since 1995. There have been several revisions. The ProQOL 5 is the current version.

PERMISSION TO USE THE ProQOL

We encourage people to use the ProQOL. The following permission is on the measure. If you would like further information about permissions, or would like to request specific permission, use the link above.

The ProQOL measure may be freely copied as long as (a) author is credited, (b) no changes are made other than those authorized below, and (c) it is not sold. You may substitute the appropriate target group for / [helper] / if that is not the best term. For example, if you are working with teachers, replace / [helper] /with teacher. Word changes may be made to any word in italicized square brackets to make the measure read more smoothly for a particular target group.

translations come from the global ProQOL users. If you can contribute a translation, or improve one, please do contact us.

We know that there are more current and accurate translations being used but do not have copies. If you have a copy of a language not listed, or a more current copy, please share it with us so we can share it with others.

Please use these translations below as a basis for the translation to the ProQOL 5. The Comparison file above shows the changes from the IV to the 5. Most were very minor and updating the translation should be relatively easy. If you need assistance, please contact us through the Request Use Permission page. We are eager to help.

1. Brazilian Portuguese (ProQOL IV)
2. Chinese (ProQOL 5)
3. Chinese-Simplified (ProQOL 5)
4. Filipino (ProQOL 5)
5. Finnish (ProQOL IV)
6. French (ProQOL 5)
7. German (ProQOL 5I)
8. Greek (ProQOL 5I)
9. Hebrew (ProQOL IV)
10. Italian (ProQOL III)
11. Japanese (ProQOL IV)
12. Khmer (ProQOL 5)

APPENDIX S:
EMAIL PERMISSION TO USE THE SCSES

From: "Bodenhorn, Nancy" <nanboden@exchange.vt.edu>
Subject: RE: Permission Request to use the School Counselor Self-Efficacy Scale
Date: July 17, 2013 2:23:47 PM EDT
To: 'Patrick Mullen' <pmullen@knights.ucf.edu>

Hello Patrick, I am glad that the SCSE will meet the needs of your research, and you certainly have my permission to use the scale in your dissertation.

Nancy

Nancy Bodenhorn
Associate Director, Office of Academic Programs
School of Education (mail code 0313)
War Memorial Hall RM 101
370 Drillfield Drive
Virginia Tech
540-231-8180

From: Patrick Mullen [mailto:pmullen@knights.ucf.edu]
Sent: Tuesday, July 16, 2013 4:36 PM
To: Bodenhorn, Nancy
Subject: Permission Request to use the School Counselor Self-Efficacy Scale

Dear Dr. Bodenhorn,

I hope you are well!

I am contacting you because I am going to be starting my dissertation shortly and I wanted to request permission to use the School Counselor Self-Efficacy Scale (SCSE) as one of my instruments. Formerly I requested to view the SCSE to consider it for my dissertation. I, along with my committee, have decided to use it, pending your permission. I will be examining the contribution of school counselors' self-efficacy and professional quality of life to their programmatic service delivery. My dissertation chair is Dr. Glenn Lambie.

Please let me know if I have your permission to use your scale in my study.

Thanks and take care!

Kind regards,

Patrick R. Mullen, M.A., NCC, ACS
Ph.D. Candidate, Counselor Education
Toni Jennings Scholar
University of Central Florida
Email: pmullen@knights.ucf.edu

APPENDIX T:
EMAIL PERMISSION TO USE AND ADJUST THE SCARS

From: "Scarborough, Janna Lynn" <SCARBORO@mail.etsu.edu>
Subject: RE: Permission Request to use the SCARS
Date: July 17, 2013 12:49:22 PM EDT
To: Patrick Mullen <pmullen@knights.ucf.edu>

Hello Patrick,

Thank you for your inquiry. Your study sounds interesting and reminds me a bit of a qualitative study I conducted. You have my permission to use the SCARS with appropriate citation. I would be interested to know what you find.

Good luck!

-Janna

Janna L. Scarborough, Ph.D.
Chair, Department of Counseling and Human Services
Associate Professor of Counseling

Clemmer College of Education
Box 70701, Warf Pickel 301E
East Tennessee State University
Johnson City, TN 37614
423-439-4191
scarboro@etsu.edu
<http://www.etsu.edu/coe/chs/>
<http://www.etsu.edu/coe/chs/counseling/>

From: Patrick Mullen [mailto:pmullen@knights.ucf.edu]
Sent: Tuesday, July 16, 2013 4:38 PM
To: Scarborough, Janna Lynn
Subject: Permission Request to use the SCARS

Dear Dr. Scarborough,

I hope you are well!

I am contacting you because I am going to be starting my dissertation shortly and I wanted to request permission to use the SCARS as one of my instruments. More specifically, I want to use to the "Actual" scale from the SCARS. I will be examining the contribution of school counselors' self-efficacy and professional quality of life to their programmatic service delivery. My dissertation chair is Dr. Glenn Lambie.

Please let me know if I have your permission to use your scale in my study.

Thanks and take care!

Kind regards,

Patrick R. Mullen
Ph.D. Candidate, Counselor Education
Toni Jennings Scholar
University of Central Florida
Email: pmullen@knights.ucf.edu

APPENDIX S:
CONFIRMATION OF DONATION TO THE AMERICAN RED CROSS

2025 E Street, NW
Washington, DC 20006

Dear Patrick Mullen,

Thank you. The American Red Cross is very grateful for your generous gift of \$96.00 on February 24, 2014 to Where It Is Needed Most .

Please see below for a copy of your tax receipt information for your donation.

The humanitarian efforts of the Red Cross provide comfort and hope to so many during their times of need. Thank you for your commitment to this critically important work. Our mission depends on the support and compassion of donors like you.

On behalf of those we serve, thank you for standing with us.

Sincerely,

A handwritten signature in cursive script that reads "Gail McGovern".

Gail McGovern
President and CEO, American Red Cross

P.S. Your questions and feedback are very important to us. Please feel free to contact us at redcross.org or call 1-800-RED CROSS (1-800-733-2767). Thank you.

REFERENCES

- American Counseling Association. (2005). *Code of ethics*. Alexandria, VA: Author.
- American School Counselor Association. (2003). *The National Model: A framework for school counseling programs* (ed.). Alexandria, VA: Author.
- American School Counselor Association (2004). *ASCA National Standards for Students*. Alexandria, VA: Author.
- American School Counselor Association. (2005). *The National Model: A framework for school counseling programs* (2nd ed.). Alexandria, VA: Author.
- American School Counselor Association. (2010). *The ASCA ethical standards*. Alexandria, VA: Author.
- American School Counselor Association. (2012). *The National Model: A framework for school counseling programs* (3rd ed.). Alexandria, VA: Author.
- American School Counselor Association (2013). *ASCA position statements*. Alexandria, VA: Author.
- Baernholdt, M., Hinton, I., Yan, G., Rose, K., & Mattos, M. (2012). Factors associated with quality of life in older adults in the United States. *Quality Of Life Research*, 21(3), 527-534.
- Baggerly, J., & Osborn, D. (2006). School counselors' career satisfaction and commitment: Correlates and predictors. *Professional School Counseling*, 9(3), 197-205.
- Balkin, R. S., & Sheperis, C. J. (2011). Evaluating and reporting statistical power in counseling research. *Journal of Counseling & Development*, 89(3), 268-272.
- Bandura, A. (1977a). Self-efficacy: Toward a unifying theory of behavioral change. *Psychological Review*, 84(2), 191-215.

- Bandura, A. (1977b). *Social learning theory*. Englewood Cliffs, N.J: Prentice Hall.
- Bandura, A. (1986). *Social foundations of thought and action: a social cognitive theory*. Englewood Cliffs, NJ: Prentice-Hall.
- Bandura, A. (1989). Regulation of cognitive processes through perceived self-efficacy. *Developmental Psychology*, 25(5), 729-735.
- Bandura, A. (1997). *Self-efficacy: The exercise of control*. New York: W.H. Freeman.
- Bandura, A., & Walters, R. H (1963). *Social learning and personality development*. New York: Holt, Rinehart & Winston.
- Bigelow, D. A., McFarland, B. H., & Olson, M. M. (1991). Quality of life of community mental health program clients: Validating a measure. *Community Mental Health Journal*, 27, 43-55.
- Bodenhorn, N. (2006). Exploratory study of common and challenging ethical dilemmas experienced by professional school counselors. *Professional School Counseling*, 10(2), 195-202.
- Bodenhorn, N., & Skaggs, G. (2005). Development of the school counselor self-efficacy scale. *Measurement and Evaluation in Counseling And Development*, 38(1), 14-28.
- Bodenhorn, N., Wolfe, E. W., & Airen, O. E. (2010). School counselor program choice and self-efficacy: Relationship to achievement gap and equity. *Professional School Counseling*, 13(3), 165-174.
- Bonomi, A., Patrick, D., Bushnell, D., & Martin, M. (2000). Validation of the United States' version of the World Health Organization Quality of Life (WHOQOL) instrument. *Journal of Clinical Epidemiology*, 53(1), 1-12.

- Borders, L., & Drury, S. M. (1992). Comprehensive school counseling programs: A review for policymakers and practitioners. *Journal of Counseling & Development, 70*(4), 487-98.
- Bollen, K. A. (1989). *Structural equations with latent variables*. New York, NY: John Wiley.
- Bosnjak, M., & Tuten, T. L. (2001). Classifying response behaviors in Web-based surveys. *Journal of Computer-Mediated Communication, 6*, 1-14.
- Bovaird, J. A., & Koziol, N. A. (2012). Measurement models for ordinal-categorical indicators. In R. H. Hoyle (Eds.). *Handbook of structural equation modeling*. (pp. 495 – 511). New York: Guilford Press.
- Bowling, N. A., Eschleman, K. J., & Wang, Q. (2010). A meta-analytic examination of the relationship between job satisfaction and subjective well-being. *Journal of Occupational and Organizational Psychology, 83*(4), 915-934.
- Bride, B.E., Hatcher, S.S., & Humble, M.N. (2009). Trauma training, trauma practices, and secondary traumatic stress among substance abuse counselors. *Traumatology, 15*(2), 96-105.
- Bride, B. E., Radey, M., & Figley, C. R. (2007). Measuring compassion fatigue. *Clinical Social Work Journal, 35*, 155-163.
- Brott, P. E., & Myers, J. E. (1999). Development of professional school counselor identity: A grounded theory. *Professional School Counseling, 5*, 339-348.
- Bryan, J. A., & Griffin, D. (2010). A multidimensional study of school-family-community partnership involvement: School, school counselor, and training factors. *Professional School Counseling, 14*(1), 75-86.
- Bryant, R. M., & Constantine, M. G. (2006). Multiple role balance, job satisfaction, and life satisfaction in women school counselors. *Professional School Counseling, 9*, 265-271

- Byrne, B. M. (1998). *Structural equation modeling with LISREL, PRELIS, and SIMPLIS: Basic concepts, applications, and programming*. Mahwah, N.J: L. Erlbaum Associates.
- Burnham, J. J., & Jackson, C. M. (2000). School counselor roles: Discrepancies between actual practice and existing models. *Professional School Counseling*, 4,41-49.
- Butler, S. K. & Constantine, M. (2005). Collective self-esteem and burnout in professional school counselors. *Professional School Counseling*, 9(1), 55-62.
- Campbell, C., & Dahir, C. (1997). *The National Standards for School Counseling Programs*. Alexandria, VA: American School Counselor Association.
- Campbell, D. T., Stanley, J. C., & Gage, N. L. (1963). *Experimental and quasi-experimental designs for research*. Chicago, Ill: R. McNally.
- Carr, A., Higginson, I., & Robinson, P. (2003). *Quality of Life*. London: BMJ.
- Cervoni, A., & DeLucia-Waack, J. (2011). Role conflict and ambiguity as predictors of job satisfaction in high school counselors. *Journal of School Counseling*, 9(1). Retrieved from <http://www.jsc.montana.edu/articles/v9n1.pdf>
- Church, A. H. (1993). Estimating the effect of incentives on mail survey response rates: A meta-analysis. *Public Opinion Quarterly*, 57(1), 62-79.
- Cicognani, E., Pietrantoni, L., Palestini, L., & Prati, G. (2009). Emergency workers' quality of life: The protective role of sense of community, efficacy beliefs and coping strategies. *Social Indicators Research*, 94(3), 449-463.
- Clark, D. M. (2006). *School counselor self-efficacy as related to the ASCA national model for school counselors*. Unpublished Doctoral Dissertation, University of North Carolina, Charlotte.

- Clemens, E. V. (2008). *A leader-member exchange approach to understanding school counselors', job satisfaction, and turnover intentions*. Unpublished Doctoral Dissertation, University of North Carolina, Greensboro.
- Clemens, E. V., Carey, J. C., & Harrington, K. M. (2010). The school counseling program implementation survey: Initial instrument development and exploratory factor analysis. *Professional School Counseling, 14*(2), 125-134.
- Clemens, E. V., Milsom, A., & Cashwell, C. S. (2009). Using leader-member exchange theory to examine principal-school counselor relationships, school counselors' roles, job satisfaction, and turnover intentions. *Professional School Counseling, 13*(2), 75-85.
- Cohen, J. (1988). *Statistical power analysis for the behavioral sciences*. Hillsdale, N.J: L. Erlbaum Associates.
- Cohen, J. (1992). A power primer. *Psychological bulletin, 112*(1), 155.
- Cole, S. T. (2005). Comparing mail and web-based survey distribution methods: Results of surveys to leisure travel retailers. *Journal of Travel Research, 43*, 422-430.
- Comrey, A. L., & Lee, H. B. (1992). *A first course in factor analysis* (2nd ed.). Hillsdale, NJ: Lawrence Erlbaum Associates.
- Cook, T. D., & Campbell, D. T. (1979). *Quasi-experimentation: Design & analysis issues for field settings*. Chicago: Rand McNally College Pub. Co.
- Coleman, H. L. K., & Yeh, C. J. (2008). *Handbook of school counseling*. New York: Routledge.
- Coll, K. M., & Freeman, B. (1997). Role conflict among elementary school counselors: A national comparison with middle and secondary school counselors. *Elementary School Guidance and Counseling, 31*, 251-271.

- Collins, S., & Long, A. (2003). Working with the psychological effects of trauma: Consequences for mental health-care workers- A literature review. *Journal of Psychiatric & Mental Health Nursing, 10*(4), 417-424.
- Converse, J. M. (1987). *Survey research in the United States: Roots and emergence, 1890 – 1960*. Berkley, CA: University of California Press.
- Converse, P. D., Wolfe, E. W., Huang, X., & Oswald, F. L. (2008). Response rates for mixed-mode surveys using mail and e-mail/web. *American Journal of Evaluation, 29*(1), 99-107.
- Council for Accreditation for Counseling and Related Educational Programs. (2009). *CACREP accreditation standards and procedures manual*. Alexandria, VA: Author.
- Couper, M. P., & Miller, P. V. (2008). Web survey method: Introduction. *Public Opinion Quarterly, 72*, 831-835.
- Craig, C., & Sprang, G. (2009). Exploratory and confirmatory factor analysis of the trauma practices questionnaire. *Research on Social Work Practice, 19*, 221_233.
- Craig, C. D., & Sprang, G. G. (2010). Compassion satisfaction, compassion fatigue, and burnout in a national sample of trauma treatment therapists. *Anxiety, Stress & Coping, 23*(3), 319-339.
- Crockett, S. A. (2012). A five-step guide to conducting SEM analysis in counseling research. *Counseling Outcome Research and Evaluation, 3*(1), 30-47.
- Groves, R. M., Dillman, D. A., Eltinge, J. L., & Little, R. J. A. (2001). *Survey nonresponse*. New York: Wiley.

- Costello, A. B., & Osborne, J. W. (2005). Best practices in exploratory factor analysis: Four recommendations for getting the most from your analysis. *Practical Assessment, Research, & Evaluation, 10*(7). Retrieved from <http://pareonline.net/genpare.asp>
- Crowne, D. P., & Marlowe, D. (1960). A new scale of social desirability independent of psychopathology. *Journal of consulting psychology, 24*(4), 349.
- Culbreth, J. R., Scarborough, J. L, Banks-Johnson, A., & Solomon, S. (2005). Role stress among practicing school counselors. *Counselor Education and Supervision, 45*,58-71.
- De Leeuw, E. D., Mellenbergh, G. J., & Hox, J. J. (1996). The influence of data collection method on structural models. *Sociology Methods & Research, 24*(4), 443-472.
- DeMato, D. S., & Curcio, C. C. (2004). Job satisfaction of elementary school counselors: A new look. *Professional School Counseling, 7*, 236-245.
- DeVoe, J., Fryer Jr., G. E., Hargraves, L., Phillips, R. L., & Green, L. A. (2002). Does career dissatisfaction affect the ability of family physicians to deliver high-quality patient care? *Journal of Family Practice, 51*(3), 223-228.
- Dillman, D. A., Smyth, J. D., & Christian, L. M. (2009). *Internet, mail, and mixed-mode surveys: The tailored design method*. New York: Wiley.
- Dimitrov, D. M. (2012). *Statistical methods for validation of assessment scale data in counseling and related fields*. Alexandria, VA: American Counseling Association.
- Dimmit, C., & Carey, J. (2007). Using the ASCA National Model to facilitate school transition. *Professional School Counseling, 10*(3), 227-232.
- Dixon, J., & Tucker, C. (2010). Survey nonresponse. In P. V. Marsden & J. D. Wright (2nd Eds.). *Handbook of survey research*. (593-630). Bingley, UK: Emerald.

- Dollarhide, C. T. (2003). School counselors as program leaders: Applying leadership contexts to school counseling. *Professional School Counseling, 6*(5), 304
- Dykema, J., Stevenson, J., Klein, L., Kim, Y., & Day, B. (2013). Effects of e-mailed versus mailed invitations and incentives on response rates, data quality, and costs in a web survey of university faculty. *Social Science Computer Review, 31*(3), 359-370.
- Eckerson, L. O., & Smith, H. M. (1966). *Scope of pupil personnel services*. Washington, D.C: U.S. Department of Health, Education, and Welfare, Office of Education.
- Eisenberg, N., Guthrie, I. K., Murphy, B. C., Shepard, S. A., Cumberland, A., & Carlo, G. (1999). Consistency and development of prosocial dispositions: A longitudinal study. *Child Development, 70*(6), 1360-1372.
- Emerson, R. M. (1976). Social exchange theory. *Annual review of sociology, 2*, 335-362.
- Emerson, E. B. (1985). Evaluating the impact of deinstitutionalisation on the lives of mentally retarded people. *American Journal of Mental Deficiency, 90*, 277-288.
- Erford, B. T. (2007). *Transforming the school counseling profession*. Upper Saddle River, N.J: Pearson Merrill/Prentice Hall.
- Ernst, K. A. (2012). *Self-efficacy, attachment, and school counselor service delivery*. Unpublished Doctoral Dissertation, George Washington University
- Education Trust. (2007). *Transforming school counseling: Benefits of becoming a transforming school counselor preparation program*, Retrieved from www.edtrust.org.
- Fabrigar, L. R., Wegener, D. T., MacCallum, R. C., & Strahan, E. J. (1999). Evaluating the use of exploratory factor analysis in psychological research. *Psychological Methods, 4*(3), 272-299.

- Falls, L., & Nichter, M. (2007). The voices of high school counselors: Lived experience of job stress. *Journal of School Counseling, 5*(13). Retrieved from <http://www.jsc.montana.edu/articles/v5n13.pdf>
- Fan, X., & Sivo, S. A. (2005). Sensitivity of fit indexes to misspecified structural or measurement model components: Rationale of two-index strategy revisited. *Structural Equation Modeling, 12*(3), 343-367.
- Figley, C. R. (1983). Catastrophes: An overview of family reactions. In C. R. Figley & H. I. McCubbin (Eds.), *Stress and the family: Vol. 2. Coping with catastrophe* (pp. 3–20). New York: Brunner/Mazel.
- Figley, C. R. (1995). Compassion fatigue: Toward a new understanding of the costs of caring. In B. H. Stamm (Ed.), *Secondary traumatic stress* (pp. 3–28). Lutherville, MD: Sidran Press.
- Figley, C. R. (2002). Compassion fatigue: Psychotherapists' chronic lack of self-care. *JCLP/In Session: Psychotherapy in Practice, 58*, 1433–1441.
- Figley, C. R., & Kleber, R. J. (1995). Beyond the “victim”: Secondary traumatic stress. In R. J. Kleber, C. R. Figley, & B. P. R. Gersons (Eds.), *Beyond trauma: Cultural and societal dynamics* (pp. 75–98). New York: Plenum.
- Fink, A. (2006). *How to conduct surveys: A step-by-step guide*. Thousand Oaks: Sage Publications.
- Fitch, T. J., & Marshall, J. L. (2004). What counselors do in high-achieving schools: A study on the role of the school counselor. *Professional School Counseling, 7*(3), 172.
- Fitts, W. H., & Warren, W. L. (1996). *Tennessee Self-concept Scale: TSCS-2. Manual*. Western Psychological Services.

- Frankel, M. (2010). Sampling theory. In P. V. Marsden & J. D. Wright (2nd Eds.). *Handbook of survey research*. (3-23). Bingley, UK: Emerald.
- Fraenkel, J. R., & Wallen, N. E. (2009). *How to design and evaluate research in education*. New York, NY: McGraw-Hill.
- Freudenberger, H.J (1974). Staff burnout. *Journal of Social Issues*, 30, 159-165.
- Freudenberger, H.J. (1975). The staff burnout syndrome in alternative institutions. *Psychotherapy, Theory, Research, and Practice*, 12, 72-83.
- Freudenberger, H. J. (1989). Burnout: Past, present, and future concerns. *Loss, Grief, & Care*, 3, 1- 9.
- Ferguson, C. J. (2009). An effect size primer: A guide for clinicians and researchers. *Professional Psychology: Research and Practice*, 40(5), 532.
- Gade, E. M., & Houdek, B. (1993). Job satisfaction and functions of counselors in split school assignments. *School Counselor*, 41,86-89.
- Gall, M. D., Gall, J. P., & Borg, W. R. (2007). *Educational research: An introduction*. Boston: Pearson/Allyn & Bacon.
- Gay, L. R. & Airasian, P. (2003). *Educational research: Competencies for analysis and application* (7th Eds.). Columbus, OH: Merrill Prentice Hall
- Granello, D. H., & Wheaton, J. E. (2004). Online data collection: Strategies for research. *Journal of Counseling and Development*, 82, 387-393.
- Granello, P. F. (2012). *Wellness counseling*. Boston: Pearson.
- Graziano, A. M., & Raulin, M. L. (2006). *Research methods: A process of inquiry*. (6th ed.). Boston, MA: Pearson.

- Greenlaw, C., & Brown-Welty, S. (2008). A comparison of web-based and paper-based survey methods testing assumptions of survey mode and response cost. *Evaluation Review*, 33(5), 464-480.
- Groves, R. M., Dillman, D. A., Eltinge, J. L., & Little, R. J. (2002). *Survey nonresponse*. New York: Wiley.
- Groves, R. M., Fowler, F. J., Couper, M. P., Lepkowski, J. M., Singer, E., & Tourangeau, R. (2004). *Survey methodology*. Hoboken, NJ: Wiley.
- Gündüz, B. (2012). Self-efficacy and burnout in professional school counselors. *Educational Sciences: Theory & Practice*, 12(3), 1761-1767.
- Gysbers, N. C. (2010). *School counseling principles: Remembering the past, shaping the future, a history of school counseling*. Alexandria, VA: American School Counselor Association.
- Gysbers, N. C., & Henderson, P. (2006). *Developing and managing your school guidance and counseling program*. Alexandria, VA: American Counseling Association.
- Hackett, G. (1981). Survey research methods. *Personnel and Guidance Journal*, 59, 599-604.
- Hair, J. F., Black, W.C., Babin, B. J., Anderson, R. E., & Tatham, R.L. (2006). *Multivariate data analysis*. Upper Saddle River, N.J: Pearson.
- Harris, H. L. (2013). A national survey of school counselors' perceptions of multiracial students. *Professional School Counseling*, 17(1), 1-19.
- Hawley, K. M., Cook, J. R., & Jensen-Doss, A. (2009). Do noncontingent incentives increase survey response rates among mental health providers? A randomized trial comparison. *Administration and Policy in Mental Health and Mental Health Services Research*, 36(5), 343-348.

- Hayslett, M. M., & Wildemuth, B. M. (2004). Pixels or pencils: Relative effectiveness of webbased versus paper surveys. *Library and Information Science Research*, 26, 73-93.
- Hebert, L. M. (2007). *Tennessee State Public School Counselors' time, tasks, and knowledge*. Unpublished Doctoral Dissertation, University of Tennessee, Knoxville, TN
- Hesse, A. (2002). Secondary trauma: How working with trauma survivors affects therapists. *Clinical Social Work Journal*, 30, 293-309.
- Holcomb-McCoy, C. C., & Day-Vines, N. (2004). Exploring school counselor multicultural competence: A multidimensional concept. *Measurement and Evaluation in Counseling and Development*, 37(3), 154-162.
- Hox, J. J., & De Leeuw, E. D. (1994). A comparison of nonresponse in mail, telephone, and face-to-face surveys. *Quality and Quantity*, 28(4), 329-344.
- Hu, L. T., & Bentler, P. M. (1999). Cutoff criteria for fit indexes in covariance structure analysis: Conventional criteria versus new alternatives. *Structural Equation Modeling: A Multidisciplinary Journal*, 6(1), 1-55.
- Ieva, K. P. (2010). *The contribution of professional school counselors' social-cognitive development to their levels of ethical and legal knowledge, and locus-of-control orientation*. (Unpublished doctoral dissertation). University of Central Florida, Orlando.
- Janson, C., Militello, M., & Kosine, N. (2008). Four Views of the Professional School Counselor—Principal Relationship: A Q-Methodology Study. *Professional School Counseling*, 11(6), 353-361.
- Johnson, B., & Christensen, L. B. (2004). *Educational research: Quantitative, qualitative, and mixed approaches*. Boston: Allyn and Bacon.
- Joinson, C. (1992). Coping with compassion fatigue. *Nursing*, 22(116), 118-119.

- Kerlinger, F. N. (1986). *Foundations of behavioral research*. New York: Holt, Rinehart and Winston.
- Kim, Y., & Seidlitz, L. (2002). Spirituality moderates the effects of stress on emotional and physical adjustment. *Personality and Individual Differences, 32*(8), 1377-1390.
- Klassen, R. M., & Chiu, M. (2010). Effects on teachers' self-efficacy and job satisfaction: Teacher gender, years of experience, and job stress. *Journal of Educational Psychology, 102*(3), 741-756.
- Kline, R. B. (2005). *Principles and practice of structural equation modeling*. New York: Guilford Press.
- Kline, R. B. (2011). *Principles and practice of structural equation modeling*. New York: Guilford Press.
- Kottler, J. A. (2010). *On being a therapist*. (4th Ed.). San Francisco: Jossey-Bass Publishers.
- Kottler, J., & Hazler, R. J. (1996). Impaired counselors: The dark side brought into light. *Journal of Humanistic Education and Development, 34*(3), 98-107.
- Krejcie, R. V., & Morgan, D. W. (1970). Determining sample size for research activities. *Educational & Psychological Measurement, 30*, 607-610.
- Kwak, N., & Radler, B. (2002). A comparison between mail and Web surveys: Response pattern, respondent profile, and data quality. *Journal of Official Statistics, 17*, 257-273.
- Laguilles, J. S., Williams, E. A., & Saunders, D. B. (2011). Can lottery incentives boost web survey response rates? Findings from four experiments. *Research In Higher Education, 52*(5), 537-553.

- Lambie, G. (2007). The contribution of ego development level to burnout in school counselors: Implications for professional school counseling. *Journal of Counseling and Development*, 85, 82-88.
- Lambie, G. W., Ieva, K. P., Mullen, P. R., & Hayes, B. G. (2011). Ego development, ethical decision-making, and legal and ethical knowledge in school counselors. *Journal of Adult Development*, 18(1), 50-59.
- Lapan, R. (2012). Comprehensive school counseling programs: In some schools for some students but not in all schools for all students *Professional School Counseling*, 16(2), 84-88.
- Lapan, R. T., Gysbers, N. C., & Sun, Y. (1997). The impact of more fully implemented guidance programs on the school experiences of high school students: A statewide evaluation study. *Journal of Counseling & Development*, 75(4), 292-302.
- Lawson, G. (2007). Wellness and impairment: A national survey. *The Journal of Humanistic Counseling, Education and Development*, 46, 20–35.
- Lawson, G., & Myers, J. E. (2011). Wellness, professional quality of life, and career-sustaining behaviors: What keeps us well?. *Journal of Counseling and Development*, 89(2), 163-171.
- Lazarus, R. S., & Folkman, S. (1984). *Stress, appraisal, and coping*. New York: Springer Pub. Co.
- Lee, S. M., Baker, C. R., Cho, S. H., Heckathorn, D. E., Holland, M. W., Newgent, R. A., et al. (2007). Development and initial psychometrics of the counselor burnout inventory. *Measurement and Evaluation in Counseling and Development*, 40, 155-168.
- Leeve, P., Bhandari, M., Sprague, S., Swiontkowski, M. F., Schemitch, E. H., Tornetta, P...Guyatt, G. H. (2004). Internet versus mailed questionnaires: A controlled

- comparison. *Journal of Medical Internet Research*, 6. Retrieved December 5, 2013 from <http://www.jmir.org/2004/4/e39/>
- Lee, T., Cai, T., MacCallum, R. C. (2012). Power analysis for tests of structural equation models. In R. H. Hoyle (Eds.). *Handbook of structural equation modeling*. (pp. 181 – 208). New York: Guilford Press.
- Lee, S. M., Cho, S. H., Kissinger, D., & Ogle, N. T. (2010). A typology of burnout in professional counselors. *Journal of Counseling & Development*, 88(2), 131-138.
- Lent, R. W., Nota, L., Soresi, S., Ginevra, M. C., Duffy, R. D., & Brown, S. D. (2011). Predicting the job and life satisfaction of Italian teachers: Test of a social cognitive model. *Journal of Vocational Behavior*, 79(1), 91-97.
- Lieberman, A. (2004). Confusion regarding school counselor functions: School leadership impacts role clarity. *Education*, 124(3), 552.
- Likert, R. (1932). A technique for measurement of attitudes. *Achieves of Psychology*, 22, 5-53.
- Limberg, D. H. (2013). *The contribution of practicing school counselors' level of altruism to their burnout*. Unpublished Doctoral Dissertation, University of Central Florida.
- Linley, P.A., & Joseph, S. (2007). Therapy work and therapists' positive and negative well-being. *Journal of Social and Clinical Psychology*, 26(3), 385-403.
- Little, T. D., Cunningham, W. A., Shahar, G., & Widaman, K. F. (2002). To parcel or not to parcel: Exploring the question, weighing the merits. *Structural Equation Modeling*, 9(2), 151-173.
- Little, R. J. A., & Rubin, D. B. (2002). *Statistical analysis with missing data*. NJ: Wiley.

- MacCallum, R. C., Browne, M. W., & Sugawara, H. M. (1996). Power analysis and determination of sample size for covariance structure modeling. *Psychological methods*, *1*(2), 130.
- Maslach, C. (1982). *Burnout, the cost of caring*. Englewood Cliffs, NJ: Prentice Hall.
- Maslach, C. (2003). *Burnout: The cost of caring*. Cambridge, MA: Malor Books.
- Maslach, C., & Jackson, S. E. (1996). Maslach Burnout Inventory-Human Services Survey 23 9 (MBI-HSS). In C. Maslach, S. E. Jackson & M. P. Leiter, *Maslach Burnout Inventory Manual* (3rd ed., p. 3-17). Palo Alto, CA: Consulting Psychology Press.
- Maslach, C., Schaufeli, W. B., & Leiter, M. P. (2001). Job burnout. *Annual Review of Psychology*, *52*, 397-422.
- Marriam-Webster Online Dictionary (n.d.). Retrieved from <http://www.m-w.com/>
- McCarthy, C, Van Horn Kerne, V., Caifa, N. A., Lambert, R.G., & Guzman, M. (2010). An exploration of school counselors' demands and resources: Relationship to stress, biographic, and caseload characteristics. *Professional School Counseling*, *13*,146-158.
- Mertler, C. A., & Vannatta, R. A. (2005). *Advanced and multivariate statistical methods: Practical application and interpretation*. Glendale, CA: Pyrczak.
- Myers, J. E., Sweeney, T. J., & Witmer, J. M. (2000). The wheel of wellness counseling for wellness: A holistic model for treatment planning. *Journal of Counseling & Development*, *78*(3), 251-266.
- Miller, N. E., & Dollard, J. (1941). *Social learning and imitation*. New Haven: Yale University Press.

- Moyer, M. (2011). Effects of non-guidance activities, supervision, and student-to-counselor ratios on school counselor burnout. *Journal of School Counseling, 9*(5). Retrieved from <http://www.jsc.montana.edu/articles/v9n5.pdf>
- Moyer, M. S., Sullivan, J. R., & Growcock, D. (2012). When is it Ethical to Inform Administrators about Student Risk-Taking Behaviors? Perceptions of School Counselors. *Professional School Counseling, 15*(3), 98-109.
- Mullen, P. R., Lambie, G. W., & Conley, A. H. (2014). Development of the Ethical and Legal Issues in Counseling Self-Efficacy Scale. *Measurement and Evaluation in Counseling and Development, 47*(1), 62-78.
- Neyman, J. (1934). On the two different aspects of the representative method: The method of stratified sampling and the method of purpose selection. *Journal of the Royal Statistical Society, 97*, 558-606.
- Norcross, J. C., & Guy, J. D. (2007). *Leaving it at the office: A guide to psychotherapist self-care*. New York: Guilford Press.
- Nussbaum, M. C., & Sen, A. (1993). *The Quality of life*. Oxford England: Clarendon Press.
- O'Brian, R. M. (1994). Identification of simple measurement models with multiple latent variables and correlated errors. In P. V. Marsden (Ed.), *Sociological methodology* (pp. 137–170). Oxford, England: Blackwell.
- Osborne, J. W. (2013). *Best practices in data cleaning: A complete guide to everything you need to do before and after collecting your data*. Thousand Oaks, Calif: SAGE.
- Olsson, U. H., Foss, T., Troye, S. V., & Howell, R. D. (2000). The performance of ML, GLS, and WLS estimation in structural equation modeling under conditions of misspecification and nonnormality. *Structural equation modeling, 7*(4), 557-595.

- Owens, D., Bodenhorn, N., & Bryant, R. (2010). Self-efficacy and multicultural competence of school counselors. *Journal of School Counseling, 8*(17), 1-20.
- Pallant, J. (2010). *SPSS survival manual: A step by step guide to data analysis using SPSS*. Open University Press.
- Peterson, S. J., Luthans, F., Avolio, B. J., Walumbwa, F. O., & Zhang, Z. (2011). Psychological capital and employee performance: A latent growth modeling approach. *Personnel Psychology, 64*(2), 427-450.
- Phelps, A., Lloyd, D., Creamer, M., & Forbes, D. (2009). Caring for carers in the aftermath of trauma. *Journal of Aggression, Maltreatment & Trauma, 18*, 313-330.
- Poghosyan, L., Clarke, S., Finlayson, M., & Aiken, L. (2010). Nurse burnout and quality of care: cross-national investigation in six countries. *Research in Nursing & Health, 33*(4), 288-298.
- Pyne, J. R. (2011). Comprehensive school counseling programs, job satisfaction, and the ASCA national model. *Professional School Counseling, 15*(2), 88-97.
- Radey, M., & Figley, C.R. (2007). The social psychology of compassion. *Clinical Social Work Journal, 35*, 207-214.
- Raykov, T., & Marcoulides, G. A. (2011). *Introduction to psychometric theory*. New York: Routledge
- Rayle, A. (2006). Do school counselors matter? Mattering as a moderator between job stress and job satisfaction. *Professional School Counseling, 9*, 206-215.
- Rayle, A. D., & Adams, J. R. (2007). An Exploration of 21st Century School Counselors' Daily Work Activities. *Journal of School Counseling, 5*(8).

- Ribak-Rosenthal, N. N. (1994). Reasons individuals become school administrators, school counselors, and teachers. *School Counselor*, 41(3), 158-64.
- Rea, L. M., & Parker, R. A. (2005). *Designing and conducting survey research: A comprehensive guide*. San Francisco: Jossey-Bass.
- Reynolds, C. R., Livingston, R. B., & Willson, V. (2010). *Measurement and assessment in education* (2nd Ed.). Upper Saddle River, NJ: Pearson.
- Robinson, B. C. (2006). *Exploring career satisfaction, burnout, and compassion fatigue as indicators of the quality of career engagement of public school educators*. Unpublished Doctoral Dissertation, University of West Virginia.
- Rotter, J. B. (1954). *Social learning and clinical psychology*. New York: Prentice-Hall.
- Rotter, J. B. (1982). *The development and applications of social learning theory*. New York: Praeger.
- Rubin, D. B. (1987). *Multiple imputation for nonresponse in surveys*. New York: Wiley.
- Sánchez-Fernández, J., Muñoz-Leiva, F., & Montoro-Ríos, F. J. (2012). Improving retention rate and response quality in Web-based surveys. *Computers in Human Behavior*, 28(2), 507-514.
- Scarborough, J. (2005). The school counselor activity rating scale: An instrument for gathering process data. *Professional School Counseling*, 8(3), 274-283
- Scarborough, J. L., & Culbreth, J. R. (2008). Examining discrepancies between actual and preferred practice of school counselors. *Journal of Counseling & Development*, 86(4), 446-459.
- Schmidt, J. J. (2008). *Counseling in schools: Comprehensive programs of responsive services for all students*. Boston: Pearson/Allyn and Bacon.

- Schumacker, R. E., & Lomax, R. G. (2010). *A beginner's guide to structural equation modeling*. Mahwah, N.J: L. Erlbaum Associates.
- Scoles, M. A. (2011). *An examination of the impact of prior teaching experience on the self-efficacy of school counselors in the state of Ohio*. Unpublished Doctoral Dissertation, Bowling Green State University.
- Shin, E., Johnson, T. P., & Rao, K. (2012). Survey mode effects on data quality: Comparison of web and mail modes in a US national panel survey. *Social Science Computer Review*, 30(2), 212-228.
- Shih, T. H., & Fan, X. (2009). Comparing response rates in e-mail and paper surveys: A meta-analysis. *Educational Research Review*, 4(1), 26-40.
- Shillingford, M. A., & Lambie, G. W. (2010). Contribution of professional school counselors' values and leadership practices to their programmatic service delivery. *Professional School Counseling*, 13(4), 208-217.
- Sink, C. A., & MacDonald, G. (1998). The status of comprehensive guidance and counseling in the United States. *Professional School Counseling*, 2(2), 88-94.
- Sink, C. A., & Yillik-Downer, A. (2001). School counselors' perceptions of comprehensive guidance and counseling programs: A national survey. *Professional School Counseling*, 4(4), 278-88.
- Sirgy, M., Michalos, A. C., Ferriss, A. L., Easterlin, R. A., Pavot, W., & Patrick, D. (2006). The quality-of-life research movement: Past, present, and future. *Social Indicators Research*, 76(3), 343-466.

- Skovholt, T. M. & Trotter-Mathison, M. J. (2010). *The resilient practitioner: Burnout prevention and self-care strategies for counselors, therapists, teachers, and health professionals*. (2nd Ed.). Boston, MA: Allyn and Bacon.
- Spielberger, C. D. (1983). *State-trait anxiety inventory for adults: sampler set: manual, test, scoring key*. Menlo Park, CA: Mind Garden.
- Sprang, G., Whitt-Woosley, A., & Clark, J. J. (2007). Compassion fatigue, compassion satisfaction, and burnout: Factors impacting a professional's quality of life. *Journal Of Loss And Trauma, 12*(3), 259-280.
- Soderfeldt, M. M., Soderfeldt, B. B., & Warg, L. E. (1995). Burnout in social work. *Social Work, 40*(5), 638-646.
- Stajkovic, A. D., & Luthans, F. (1998). Self-efficacy and work-related performance: A meta-analysis. *Psychological Bulletin, 124*(2), 240-261.
- Stamm, B. H. (2005). *The ProQOL manual. The Professional Quality of Life Scale: Compassion Satisfaction, Burnout, and Compassion Fatigue/Secondary Trauma scales*. Pocatello: Idaho State University and Sidran Press.
- Stamm, B. H. (2010). *The Concise ProQOL Manual*, Pocatello, ID: Author.
- Stevens, J. P. (1992). *Applied multivariate statistics for the social sciences* (2nd ed.). Hillsdale, NJ: Erlbaum.
- Stevens, J. P. (1996). *Applied multivariate statistics for the social sciences* (3rd ed.). Mahwah, NJ: Lawrence Erlbaum.
- Strahan, R., & Gerbasi, K. (1972). Short, homogeneous versions of the Marlow-Crowne social desirability scale. *Journal of Clinical Psychology, 28*(2), 191-193.
- Tabachnick, B. G., & Fidell, L. S. (2007). *Using multivariate statistics*, (5th ed). Boston, MA:

Allyn and Bacon.

Texas Education Agency. (1996). *Texas school counseling and guidance programs: Final study report*. Austin, TX: Author. (ERIC Document Reproduction Service No. ED429240).

Tillman, A. (2013). Improving Worker Satisfaction Yields Improved Worker- Retention Rates. *Employment Relations Today*, 39(4), 27-31.

Thurstone, L. L., & Chave, E. J. (1929). *The measurement of attitude: A psychophysical method and some experiments with a scale for measuring attitude toward the church*. Chicago, Ill: The University of Chicago Press.

Walz, G. R. (1988). *Research and counseling: Building strong school counseling programs*. Alexandria, VA: American Association for Counseling and Development.

Weston, R., & Gore, P. A. (2006). A brief guide to structural equation modeling. *The Counseling Psychologist*, 34(5), 719-751.

Wilkerson, K. (2009). An examination of burnout among counselors guided by Stress-Strain-Coping Theory. *Journal of Counseling & Development*, 87, 428-437.

Wilkerson, K., & Bellini, J., (2006). Intrapersonal and organizational factors associated with burnout among school counselors. *Journal of Counseling & Development*, 84, 440-450.

Wilson, P., Petticrew, M., Calnan, M., & Nazareth, I. (2010). Effects of a financial incentive on health researchers' response to an online survey: A randomized controlled trial. *Journal Of Medical Internet Research*, 12(2).

Whiston, S. C., Tai, W., Rahardja, D., & Eder, K. (2011). School counseling outcome: A meta-analytic examination of interventions. *Journal of Counseling & Development*, 89(1), 37-55.

- Wolfe, E. W. (2003). Using logistic regression to detect item-level non-response bias in surveys. *Journal of Applied Measurement*, 4, 234-248.
- Wolfe, E. W., Converse, P. D., Airen, O., & Bodenhorn, N. (2009). Unit and item nonresponses and ancillary information in web-and paper-based questionnaires administered to school counselors. *Measurement and Evaluation in Counseling and Development*, 42(2), 92-103.
- Wolfe, E. W., Converse, P. D., & Oswald, F. L. (2008). Item- level nonresponse rates in an attitudinal survey of teachers delivered via mail and Web. *Journal of Computer- Mediated Communication*, 14(1), 35-66.
- World Health Organization. (1998). *WHOOQL user manual*. Geneva, Switzerland: Author
- Woods, K. W. (2009). *Self-efficacy as a mediator in the relationship between non-counseling roles and wellness in school counselors*. Unpublished Doctoral Dissertation, Texas Tech University.
- Wight, J. D., & Marsden, P. V. (2010). Survey research and social science: History, current practice, and future prospects. In P. V. Marsden & J. D. Wright (2nd Eds.). *Handbook of survey research*. (3-23). Bingley, UK: Emerald.