

**IMPROVING PROJECT MANAGEMENT WITH
SIMULATION AND COMPLETION DISTRIBUTION FUNCTIONS**

by

GRANT R. CATES
B.S. Colorado State University, 1981
M.S. University of Central Florida, 1996

A dissertation submitted in partial fulfillment of the requirements
for the degree of Doctor of Philosophy
in the Department of Industrial Engineering and Management Sciences
in the College of Engineering and Computer Sciences
at the University of Central Florida
Orlando, Florida

Fall Term
2004

© 2004 Grant R. Cates

ABSTRACT

Despite the critical importance of project completion timeliness, management practices in place today remain inadequate for addressing the persistent problem of project completion tardiness. Uncertainty has been identified as a contributing factor in late projects. This uncertainty resides in activity duration estimates, unplanned upsetting events, and the potential unavailability of critical resources.

This research developed a comprehensive simulation based methodology for conducting quantitative project completion-time risk assessments. The methodology enables project stakeholders to visualize uncertainty or risk, i.e. the likelihood of their project completing late and the magnitude of the lateness, by providing them with a completion time distribution function of their projects. Discrete event simulation is used to determine a project's completion distribution function.

The project simulation is populated with both deterministic and stochastic elements. Deterministic inputs include planned activities and resource requirements. Stochastic inputs include activity duration growth distributions, probabilities for unplanned upsetting events, and other dynamic constraints upon project activities. Stochastic inputs are based upon past data from similar projects. The time for an entity to complete the simulation network, subject to both the deterministic and stochastic factors, represents the time to complete the project. Multiple replications of the simulation are run

to create the completion distribution function.

The methodology was demonstrated to be effective for the on-going project to assemble the International Space Station. Approximately \$500 million per month is being spent on this project, which is scheduled to complete by 2010. Project stakeholders participated in determining and managing completion distribution functions. The first result was improved project completion risk awareness. Secondly, mitigation options were analyzed to improve project completion performance and reduce total project cost.

ACKNOWLEDGMENTS

First and foremost, I thank Dr. Mansooreh Mollaghasemi for introducing me to discrete event simulation modeling and for mentoring me through the subsequent projects, classes, and this resulting dissertation. Likewise, the members of my dissertation committee, Dr. Linda Malone, Dr. Michael Georgiopoulos, Dr. Tim Kotnour, and Dr. Luis Rabelo provided extremely valuable leadership as well. Dr. Martin Steele of NASA, Dr. José Sepulveda of UCF, and Dr. Ghaith Rabadi of Old Dominion University also provided greatly appreciated guidance.

My participation in a graduate program would not have been possible without the tremendous encouragement and support I received from numerous NASA and UCF officials. These include Conrad Nagel, Mike Wetmore, and Dave King all of whom recommended me for the Kennedy Graduate Fellowship Program. My participation in that program was expertly administered by Kari Heminger, June Perez, Chris Weaver, and Ed Markowski all from NASA, along with Don Hutsko of the United States Department of Agriculture. General Roy Bridges and Jim Kennedy as directors of the Kennedy Space Center provided the vision and leadership for the partnership between NASA and the University of Central Florida. Special thanks to Joy Tatlonghari, for providing the administrative guidance and support throughout the entire program of classes, research, and dissertation. Thanks to UCF thesis Editor Katie Grigg as well as

NASA's Bill Raines, Sam Lewellen, and Wayne Ranow for their assistance during the publication process.

The support and encouragement I received from a host of current and former NASA officials all steadfastly determined to create the greatest Space Station ever built was nothing short of fantastic. These skilled and dedicated individuals include Mike Leinbach, Steve Cash, Pepper Phillips, Frank Izquierdo, Doug Lyons, Jeff Angermeier, Tom Overton, Andy Warren, Jessica Mock, John Coggeshall, John Shannon, Ron Dittimore, Bill Gerstenmaier, Bill Parsons, Tassos Abadiotakis, Scott Thurston, Stephanie Stilson, Shari Bianco, Bill Hill, Elric McHenry, and Larry Ross.

In particular I wish to thank Janet Letchworth and Bill Cirillo both of NASA along with Joe Fragola, Blake Putney, and Chel Stromgren all of SAIC, and Dan Heimerdinger of Valador Inc., for their many contributions to the evolution of this research.

I also received greatly appreciated support and encouragement from Dawn Cannister and Tom Hayson of Rockwell Software with respect to the use of the *Arena* simulation software. Dr. Averill Law of Averill M. Law and Associates provided guidance on simulation modeling as well as the use of their excellent *ExpertFit* software.

My family provided great support throughout. Thanks to my parents, Chuck and Iola Cates, my brother Rick, my sister Leslie and her husband Kevin Blackham, and my sister Wendy and her husband Jeff Jones. My greatest appreciation is to my wife Alicia for her love, encouragement, and patience.

TABLE OF CONTENTS

LIST OF FIGURES	xii
LIST OF TABLES	xv
LIST OF ABBREVIATIONS.....	xvi
CHAPTER ONE: INTRODUCTION.....	1
Large Projects Advanced Science of Project Management	5
PAST and the International Space Station.....	8
Applicability to Other Projects	9
Overview of Subsequent Chapters.....	10
CHAPTER TWO: LITERATURE REVIEW	11
Project Schedule Risk Analysis/Assessment	11
Project Management Tools	16
Gantt Charts	17
CPM	17
PERT.....	18
Activity Duration Specification	19
Estimating Project Completion Times	21
Precedence Diagramming	25
Merging of PERT, CPM, and Precedence Diagramming	25

Performance Measurement and Earned Value.....	27
GERT and Q-GERT.....	27
VERT.....	29
The Project Management Institute.....	30
Critical Chain Project Management.....	32
Activity Embedded Safety Time.....	35
Project and Feeding Buffers.....	38
CCPM on Project Completion Time Distribution Function.....	40
Empirical Data for Input Analysis.....	41
CHAPTER THREE: METHODOLOGY.....	44
Part I: The Project Assessment by Simulation Technique (PAST).....	44
Managerial Controls Component of PAST.....	47
Introductory Briefings.....	48
Assessment Requirements.....	49
Communications.....	49
Simulation Modeling Component of PAST.....	50
Activity Construct.....	53
Probabilistic Event Construct.....	61
Cyclical Element Construct.....	62
Input Analysis Component of PAST.....	63
Output Analysis Component of PAST.....	67
Creating the PCDF.....	68

Determining the PCDF Confidence Band.....	69
Verification and Validation for PAST	73
Verification	73
Validation.....	74
Measuring Progress.....	76
Part II: Research Methodology (Case Study)	77
Case Study Definitions	78
Components of Research Design	79
Study Question.....	79
Proposition	80
Units of Measurement.....	81
Logic for Linking Data to Proposition.....	82
Criteria for Interpreting the Findings.....	83
Ensuring Case Study Design Quality.....	83
Construct Validity	84
Internal Validity	87
External Validity.....	87
Reliability.....	88
The Specific Case Study Design.....	88
CHAPTER FOUR: FINDINGS	90
Section I: The Pilot Case Study	90
Background.....	91

Space Shuttle Processing Flow	94
Margin Assessment Results	98
Initial Analysis of the Project Margin Problem	100
Project Assessment by Simulation Technique Prototype	105
Managerial Controls Component.....	105
Simulation Model Component.....	106
Input Analysis Component	108
Verification	110
Output Analysis	111
Section II: Three Additional Case Studies.....	116
Background Information.....	116
Case Study 1: Launch Window Analysis.....	118
Case Study 2: Manifest Option 04A-29.....	122
Work Force Augmentation	125
Reducing Project Content	128
Case Study 3: Project Buffer Benefit.....	129
Section III: Evolution of PAST.....	133
Modeling Automation.....	134
Output Analysis Automation	135
Management Issues.....	136
PAST: Step-by-Step.....	137
Scale of Effort.....	139

Organizational Residence	140
Analysis Distribution Controls	140
The Completion <i>Quantity</i> Distribution Function Graphic	142
CHAPTER FIVE: CONCLUSION.....	146
Summary of Case Study Results.....	146
Observations and Recommendations.....	148
Completion Quantity Distribution Function	148
Timeliness of Analysis.....	149
Politics of Risk Assessment.....	150
Future Research	152
Continued Use of PAST to Support ISS Assembly	152
PAST and Critical Chain Project Management	156
The PAST Input Analysis Methodology.....	157
Closing Thoughts	157
END NOTES	159
LIST OF REFERENCES	161

LIST OF FIGURES

Figure 1: The Four Components of PAST	2
Figure 2: Example Project Completion Distribution Function	4
Figure 3: Improved Project Completion Timeliness.....	5
Figure 4: Activity Duration Distribution Function	35
Figure 5: Multitasking Increases Task Durations	37
Figure 6: Visual Display of Project Completion Risk (Example)	44
Figure 7: Overview of the PAST Methodology.....	45
Figure 8: PAST Flow Diagram.....	46
Figure 9: Simulation Modeling Component	51
Figure 10: Activity Modeling Construct with Deterministic Duration and Reserve	55
Figure 11: Activity Modeling Construct with Stochastic Duration Added	56
Figure 12: Reserve Reduction Feature Added to Activity Construct	58
Figure 13: Resource Element Added to Activity Construct	59
Figure 14: Completed Activity Construct.....	60
Figure 15: Predictable Need to Use an Alternate Route	61
Figure 16: Cyclical Process	62
Figure 17: Input Analysis for Activity Construct	63

Figure 18: Input Analysis Component of PAST.....	64
Figure 19: Output Analysis Component of PAST	67
Figure 20: Presentation of a Project Completion Time Density Function.....	69
Figure 21: Graphical Presentation of Confidence Band	72
Figure 22: Notional Project Planned Completion Date versus PCDF	81
Figure 23: Research Methodology Chronological Overview	89
Figure 24: Space Shuttle Orbiter Space Station Assembly Sequence	92
Figure 25: Orbiter Resource Utilization Chart.....	93
Figure 26: Space Shuttle Mission Cycle.....	94
Figure 27: Shuttle Gantt Chart.....	95
Figure 28: Work Days Added to the OPF Flow Post Delta LSFR	101
Figure 29: Histogram and CFD for OPF Added Work Days.....	102
Figure 30: Available Margin Diagram for the Node-2 Milestone	104
Figure 31: OPF Empirical Distribution for Added Work Days	109
Figure 32: Completion Time Distribution Function for STS-120 Launch Date.....	111
Figure 33: Working Holidays Improves STS-120 Launch Date	114
Figure 34: STS-120 Launch Date Improvement from Working Holidays	115
Figure 35: Launch Window Analysis	120
Figure 36: Launch Probability with Winter Weather Modifier	121
Figure 37: Launch Probability Comparisons	122
Figure 38: Initial Analysis of 04A-29 Manifest Option.....	124
Figure 39: Potential Benefit from Workforce Augmentation.....	127

Figure 40: CTDF for STS-141 Launch Month	129
Figure 41: Analysis of 04A-49 Option with S1.O Assumptions	131
Figure 42: Confidence Bands for STS-136 Launch Date	132
Figure 43: Modeling Component of PAST.....	134
Figure 44: Organizational Hierarchy	141
Figure 45: CQDF for Analysis Team.....	143
Figure 46: CQDF with PLOV at .01	144
Figure 47: Improvement from Elimination of Launch on Need Requirement	145
Figure 48: Accelerating ISS Assembly Completion.....	153

LIST OF TABLES

Table 1: Buffer Sizes as Proposed by Yongyi Shou and Yeo.....	40
Table 2: Confidence Band Calculation	71
Table 3: Margin Assessment.....	99
Table 4: Margin Days Required To Ensure Next Project Starts on Time	103
Table 5: 04A-29 Manifest Option.....	123
Table 6: 04A-49 Manifest Option.....	130

LIST OF ABBREVIATIONS

AOA	Activity on Arrow
AON	Activity on Node
AXAF	Advanced X-Ray Astrophysics Facility
CAIB	Columbia Accident Investigation Board
CCPM	Critical Chain Project Management
CPM	Critical Path Method
CQDF	Completion Quantity Distribution Function
CTD	Completion Time Distribution
CTDF	Completion Time Distribution Function
DES	Discrete Event Simulation
DFRC	Dryden Flight Research Center
DOD	Department of Defense
GERT	Graphical Evaluation and Review Technique
ISS	International Space Station
KSC	Kennedy Space Center
LON	Launch on Need
MAST	Manifest Analysis by Simulation Tool
MPS	Main Propulsion System

NASA	National Aeronautics and Space Administration
OPF	Orbiter Processing Facility
PAST	Project Assessment by Simulation Technique
PCDF	Project Completion Distribution Function
PDM	Precedence Diagramming Network
PERT	Project Evaluation and Review Technique
PLOV	Probability of Loss of Vehicle
PMI	Project Management Institute
PRACA	Problem Reporting and Corrective Action
STS	Space Transportation System
TOC	Theory of Constraints
VAB	Vehicle Assembly Building
VERT	Venture Evaluation and Review Technique

CHAPTER ONE: INTRODUCTION

Despite the critical importance of project completion timeliness, project management practices in place today remain inadequate for addressing the persistent problem of project completion tardiness. A major culprit causing project completion tardiness is uncertainty, which most, if not all, projects are inherently subjected to (Goldratt 1997). This uncertainty is present in many places including the estimates for activity durations, the occurrence of unplanned and unforeseen events, and the availability of critical resources. In planning, scheduling, and controlling their projects, managers may use tools such as Gantt charts and or network diagrams such as those provided by Project Evaluation and Review Technique (PERT) or Critical Path Method (CPM). These tools, however, are limited in their ability to help managers quantify project completion risk. Consequently, large and highly important projects can end up finishing later than planned and project stakeholders including politicians, project managers, and project customers may be unpleasantly surprised when this happens.

The typically cited method for quantitative schedule risk analysis has been called “stochastic CPM” (Galway 2004). This process uses Monte Carlo simulation to analyze a project network in order to produce a project completion distribution function. However, as noted by Galway (2004) there is lack of literature on the use of this technique in practice and a lack of case studies that illustrate when this method works or fails.

Consequently, developing a more complete practical methodology for quantitative project completion timeliness analysis and demonstrating its effectiveness in a real world application would seem to be advised.

This research develops a comprehensive methodology for project schedule risk analysis. It is called the Project Assessment by Simulation Technique (PAST) and consists of four major components. These are the managerial controls, modeling, input analysis, and output analysis components. Figure 1 shows the components of PAST and how they are interconnected in a logical fashion.

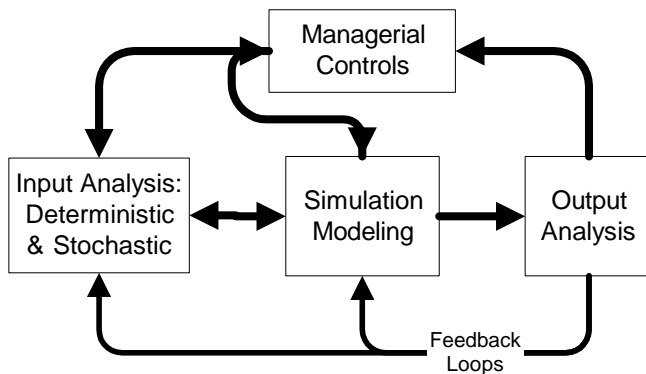

File: Project Analysis Process R1.vsd

Figure 1: The Four Components of PAST

PAST and its four major components are described briefly below. They are fully described in Chapter 3. The managerial controls component provides a facilitating interface between those performing the assessment and the project stakeholders. The input analysis component contains both deterministic and stochastic elements. The

deterministic element includes the schedule information such as project activities, their durations, along with their precedence and critical resource requirements. This information is used to create a simulation model of the project. The simulation model includes stochastic inputs in the form of potential growth in activity durations and the probability of upsetting events occurring during the project. These upsetting events may cause project stoppages or may require the addition of new work. The basis of estimate for the stochastic inputs stems from empirical information. The simulation model of the project is run for many hundreds or thousands of replications so as to produce a large quantity of possible project completion end dates. This data set is then used by the output analysis component to create a visual display of project completion uncertainty in the form of a completion distribution function.

Project stakeholders can visualize project performance uncertainty, e.g. the likelihood of the project completing late and the magnitude of the lateness, by being shown the completion distribution function for the project. Figure 2 is an example of a project completion distribution function. For this notional project, the planned completion time is October of 2010. The simulation derived completion distribution function for the project indicates that there is only an approximately 30 percent chance of completing the project by that time. Moreover, the project may finish as much as a year late.

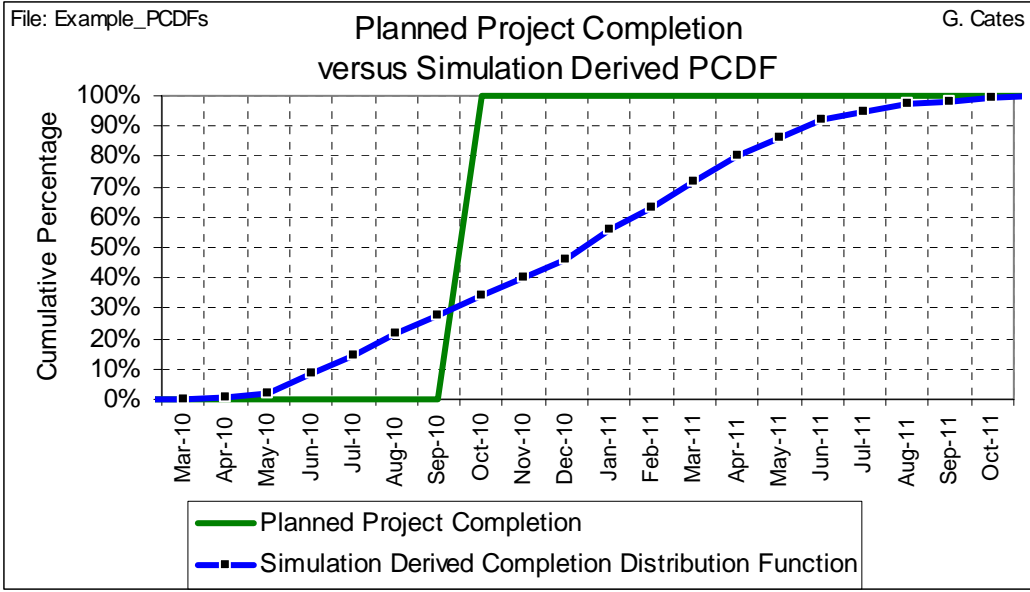

Figure 2: Example Project Completion Distribution Function

The Project Assessment by Simulation Technique allows one to not only quantify risk to project completion timeliness but also enables the analysis of managerial decisions on project completion timeliness. For example, suppose the project manager responded to the projection shown in Figure 2 by suggesting the elimination of project content, or by increasing staffing on a critical path task, or any number of similar actions intended to improve project completion timeliness. The likely results of those proposed actions could be quantified prior to implementing them. Figure 3 shows the improvement in the notional project likely to result from the proposed project management actions.

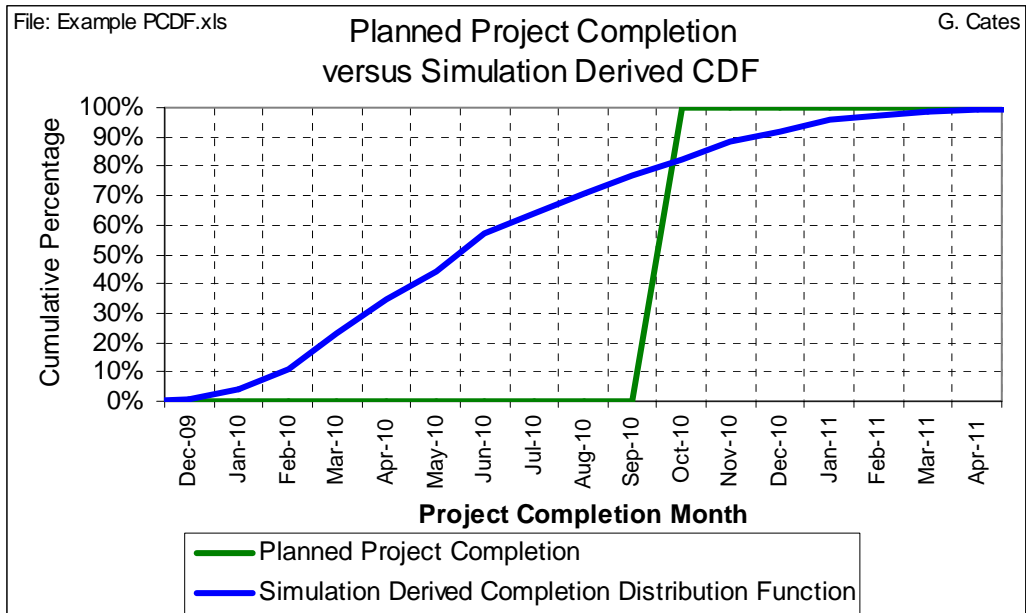

Figure 3: Improved Project Completion Timeliness

In the above example the proposed action of the project manager increased the likelihood of on-time project completion to approximately 80 percent.

Large Projects Advanced Science of Project Management

The importance of this research comes from the importance that is placed upon project completion performance particularly with respect to large projects. Examples of large projects include cargo ship building during World War I, the Manhattan Project to build the first Atomic Bomb, the Polaris missile program, the Minuteman missile program, and the Apollo program. The science of project management has been advanced as a result of such critically important large projects.

During World War I there was a pressing need for cargo ships in order to transfer war supplies from America to Europe. Henry Gantt reduced the time to build cargo ships through the use of bar charts he invented. The charts, later to be named Gantt charts, visually displayed the activities, and their durations, required to build each ship. In World War II robust and accurate project planning, scheduling, and tracking methods were required and developed to carry out the Manhattan Project (Morris 1994, 1997).

During the 1950s, the United States began to grow concerned about the Soviet Union's advancement in space and especially with respect to their deploying nuclear capable intercontinental ballistic missiles. This fear had profound effects upon the United States and served to spark a space race to develop ICBMs. The United States Air Force managed the development of ground based ICBMs. The liquid fueled rocket was called Atlas and the solid fueled rocket was called Minuteman. The Navy managed a similar project—the Polaris Missile Project—to develop an ICBM to be launched from submarines. It was critically important to national survival to develop these systems as soon as possible. The science of project management was advanced out of this necessity.

The Project Evaluation and Review Technique (PERT) was developed to support the Polaris project (Malcolm 1959; Levin and Kirkpatrick 1966; Moder et al 1983). According to the Navy, through using PERT, the Polaris project was completed two years ahead of the original estimated schedule completion date.^{1 2}

In 1957, the Soviet Union became the first nation to place a satellite—Sputnik—in orbit around the earth. The event increased the pressure upon the American military to deploy the Atlas and Polaris missile systems as soon as possible. Sputnik also prompted

the creation, in 1958, of the National Aeronautics and Space Administration (NASA). The Mercury program, initiated in 1958, was NASA's project for placing an American in space before the Soviet Union. In April of 1961, the Soviets were the first to achieve this milestone when they orbited Yuri Gagarin around the earth. In May the United States responded with the suborbital launch of Alan Sheppard. As the Soviet Union was clearly leading the space race President Kennedy established a project that was far enough away and difficult enough to achieve such that the United States would have an opportunity to catch and surpass the Soviets. This project was the landing of an American on the moon. Kennedy set the completion milestone of 'by the end of the 1960s.'

It is interesting to note that President Kennedy, in announcing the decision to go to the moon gave the nation a large project completion buffer. The original estimate was that the United States could land on the moon by as early as 1966 or 1967 (Johnson 1971). In his public announcement, Kennedy charged that the moon landing should occur by the end of the decade. Thus, there was anywhere from a 3 to 4 year project buffer.³

The Apollo program—the project to achieve the manned lunar landing—has been called a “paradigm of modern project management” (Morris, 1997). During the program the project management techniques described above were used and in some cases improved upon. Additionally, new project management techniques were developed that have since become commonplace in project management. Examples include phased project planning and configuration control.

In 1962, NASA and the Department of Defense published the “DoD and NASA Guide PERT/Cost Systems Design.” This newer PERT/Cost system included a cost

element, which was not included in the original PERT. Additionally, the 1962 guide introduced government management to the Work Breakdown Structure. The Work Breakdown Structure has since become a central component of management for large government projects (Morris, 1997).

In 1963, Brigadier General Phillips on the Minuteman ICBM program developed the Earned Value system (Morris 1994, 1997). Earned Value has also gone on to being a widely used tool for project management (Fleming & Koppelman 2000).

In 1966 A. Alan B. Pritsker of the RAND Corporation developed the Graphical Evaluation and Review Technique (GERT) for NASA's Apollo program (Pritsker 1966). In GERT branches of the project network can have a probabilistic chance of not having to be accomplished whereas in PERT/CPM all branches must be accomplished. GERT allows for looking back in the project and repeating earlier steps whereas PERT/CPM are 'one time through' networks.

PAST and the International Space Station

The Project Assessment by Simulation Technique (PAST) like Gantt charts, PERT, and GERT was developed to meet the specific needs of a large and important project. The particular project that sparked the need for PAST is the on-going effort to assemble the International Space Station. Additionally, this research not only developed a new methodology for project risk analysis, but also used case study research techniques to demonstrate the use and effectiveness of this new management tool on that project.

Project stakeholders participated in developing and managing completion distribution functions for that project. The results were improved project completion risk awareness and projected improvements in project completion performance. Timely completion of the International Space Station project will free up billions of dollars in annual funding required to begin important follow-on space projects e.g. returning to the moon and landing on Mars.

Furthermore, just like these earlier project management tools such as Gantt charts and PERT, the PAST methods may be applicable to other projects.

Applicability to Other Projects

Financial benefit/penalty based on project completion is a widely used strategy on highway construction projects (Jaraiedi et al 2002). The contractor is rewarded for finishing early and penalized for finishing late. Consequently, it is desirable to accurately quantify the completion time distribution function of the project. This ability may be important during the project bid and/or planning phases as well during the project. For example a contracting agency should have some idea of the risk associated with a project before establishing the financial incentives and disincentives for the contract for that project. The companies bidding on the contract require similar knowledge in order to submit a competitive bid that if chosen will allow them to earn a profit.

Overview of Subsequent Chapters

The literature review in Chapter 2 focuses first on the most recent work concerning project risk analysis and the use of simulation. The chapter then shifts to a chronological review of management tools, including Gantt charts, PERT, etc., the Project Management Institute, and the Critical Chain Project Management philosophy. The chapter concludes with a brief review regarding using empirical data to develop (1) probability distributions for activity durations and (2) event probabilities. Chapter 3 presents the details of the Project Completion Distribution Function methodology and also develops the ground rules for conducting subsequent case studies in a real world environment to determine if the methodology provides practical benefits. Chapter 4 describes the case studies in detail and presents the results. Chapter 5 summarizes and concludes the research.

CHAPTER TWO: LITERATURE REVIEW

There is an extensive body of literature on the subject of project management. This review focuses upon that subset pertaining to project analysis, risk, and uncertainty with respect to completion performance. The more recent literature specific to project schedule risk analysis and assessment is presented first as it is most germane to the research presented in subsequent chapters. The chapter also includes a historical review regarding the development of classic project management tools pertaining to schedule risk during the twentieth century. These include Gantt Charts, PERT/CPM, Precedence Diagramming, GERT/Q-GERT and VERT. The formation of the Project Management Institute is presented along with the relevant recommendations from that organization with respect to handling project risk and uncertainty. The Critical Chain Project Management philosophy is also discussed. The chapter concludes with a review of literature pertaining to the use of empirical data for estimating project activity durations.

Project Schedule Risk Analysis/Assessment

Galway (2004) states that the literature on project risk analysis, which typically includes both cost and schedule risk, is found primarily in textbooks along with some professional society sponsored tutorials and training seminars. There are a few textbooks

dedicated to project risk analysis such as Schuyler (2001). However, their content can be found in more general texts on risk analysis including Cooper and Chapman 1987), Vose (1996, 2000), and Bedford and Cooke (2001).

The typically cited procedure for project schedule risk analysis may be referred to as ‘stochastic CPM,’ (Galway 2004). This process starts with a project network that is then analyzed using Monte Carlo simulation. Soliciting expert opinion is the typically recommended method for obtaining probability distributions for task durations and probabilities for events. Bedford and Cooke (2001) state that, “it is the exception rather than the rule to have access to reliable and applicable historical data.” The estimates of the experts are most likely to be converted into triangular distributions in the case of activity durations. For events, Bedford and Cooke suggest that experts be asked for the probability of the event and if it occurs how long the resulting delay would be. Output analysis focuses on (1) understanding the project completion distribution function and (2) determining the probability that any given task is on the critical path.

The use of cumulative frequency distributions is the graphic of choice with respect to presenting the completion time of the project. Vose (1996), Bedford and Cooke (2001), and Roberts et al (2003) all utilize cumulative distribution functions for representing the project completion time results from the Monte Carlo simulation. However, none of these sources discuss the confidence interval or band for the CDF.

There is also typically little or no information presented with respect to how one goes about managing such an analysis in a real world environment. Galway emphasized the lack of literature on the actual use of this technique.

The striking lack in the textbook literature is that there is little literature cited on the *use* of the techniques. That is, there are no pointers to critical literature about the techniques such as when they are useful, or if there are any projects or project characteristics that would make it difficult to apply these methods. There are also few or no sets of case studies that would illustrate when the methods worked or failed.⁴

Galway (2004) expresses concern that the literature examples of simulation assessments for project completion times were typically anecdotal. For example, Roberts et al (2003) cited success in using project completion distribution functions provided via Monte Carlo simulation but did not go into detail.

Monte Carlo Simulation, as opposed to Discrete Event Simulation (DES), seems to dominate the project management literature. This may stem from the manner in which DES is taught. Foundational books on DES such as Law and Kelton's, *Simulation, Modeling, and Analysis*, Kelton, Sadowski, and Sadowski's, *Simulation with Arena*, and Banks et al's *Discrete-Event System Simulation* do not discuss using DES for project management. Nonetheless, DES seems ideally suited for modeling projects and analyzing when project completion may occur. First, there is the ability of DES to handle stochastic input and output. Secondly, the basic constructs of commercially available DES software e.g. Arena by Rockwell Software are similar to PERT-CPM constructs i.e. activity on node network diagrams. DES software also allows one to include multiple resource constraints, which all projects are subject to at least to some degree.

There are more recent examples of DES being suggested for use in project management. Ottjes and Veeke (2000) and Simmons (2002) used discrete event simulation to model PERT/CPM project networks so as to determine the completion time distribution of example projects.

Williams (1995), in his classified bibliography of recent research on project risk management, stated that no research had been done on analytical techniques for project networks having resource constraints. He noted that simulation and modeling of projects with either resource constraints or complex uncertainties was the advised technique. He cited research by Kidd (1991) as an example.

Kidd (1991) demonstrated how a manager can get a different message regarding the risk of completing a project on time based upon which tool is used i.e. CPM, PERT, or VERT. In Kidd's example, the project manager would have to pay a penalty if the project duration was greater than 52 days. With the deterministic based CPM, the project completed on time by definition. The same project modeled using the PERT method showed a high probability of completing in 52 days. With the simulation based method titled VERT (Venture and Evaluation and Review Technique), the project had a low probability of completing in 52 days. Also of note here is that the VERT results were presented as a project completion time distribution.

Kidd proposed that, as a rule, the simulation based VERT should be used for projects having uncertainty and stochastic branching. Kidd acknowledged that VERT was more expensive than PERT, which was in turn more expensive than CPM. Nonetheless, VERT was warranted for complex projects where the costs of failure were high.

While VERT has not grown into a widely used project management tool, the capacity to conduct simulation modeling of projects has increased. Voss (1996) lists several products that enable Monte Carlo modeling of projects. These include @RISK (an add-on to Microsoft Excel and Microsoft Project) by Palisade; Monte Carlo by Euro Log Limited; OPERA by Welcom Software Technology UK; PREDICT! by Risk Decisions UK; RISK 7000 by Chaucer Group Ltd UK; and RISK+ by Program Management Solutions, Inc.

The Project Management Institute, in the 2000 edition of the Project Management Body of Knowledge (PMBOK®) identifies Monte Carlo simulation, along with decision analysis, as a viable tool for conducting quantitative risk analysis. “A project simulation uses a model that translates the uncertainties specified at a detailed level into their potential impact on objectives that are expressed at the level of the total project. Project simulations are typically performed using the Monte Carlo technique.” Examples of outputs from quantitative risk analysis include forecasts for possible completion dates and their associated confidence levels, and the probability of completing the project on schedule. As the project progresses and assuming quantitative analysis is repeated, trends can also be identified.⁵

Project Management Tools

Morris (1994, 1997) provides an excellent in depth history and evolution of the management of projects in general. He includes discussion and references for project management tools including those directly related to schedule risk. Galway (2004), with acknowledgement to Morris, presents a more narrowly focused discussion on the history, evolution, and current state of quantitative risk analysis tools and methods for project management.

The development of twentieth century project management tools began in the early 1900s with the establishment of Gantt charts. In the late 1950s two analytical methodologies for project management were developed independently. These were Critical Path Method (CPM) and Project Evaluation and Review Technique (PERT). CPM consists of precedence network diagrams that map or connect the activities required to complete the project. PERT also consists of similar diagrams. Subsequent to the independent development of CPM and PERT in the late 1950s and early 1960s, these tools have become synonymous. They are sometimes referred to as PERT-CPM. While both PERT and CPM are similar in form, there are differences in their functionality. Development of the GERT and VERT tools followed shortly after the PERT/CPM tools became well known.

Gantt Charts

In 1908 Henry Lawrence Gantt of the Philadelphia Naval Shipyard developed milestone charts that displayed transatlantic shipping schedules (Gantt, 1919; Rathe, 1961; Devaux, 1999). These charts were later adapted so as to be used on any project. A Gantt chart displays tasks to be done in a project in a waterfall fashion along with the duration of the tasks. The typically cited weakness of Gantt charts is their inability to show the interrelationships between the tasks (Morris, 1997). This is especially true for complex projects (Galway, 2004). Nonetheless, Gantt charts, which are sometimes referred to as “bar charts,” are an excellent visual tool and are still widely used (Devaux, 1999).⁶

CPM

Critical Path Method (CPM) was developed in the 1956-1959 timeframe for plant maintenance and construction projects by the du Pont Company and Remington Rand Univac (Walker and Sayer 1959). Kelly (1961) described the mathematical basis for CPM. Moder et al (1983) stated that a prime focus of the CPM developers was to create a method for quantifying the tradeoffs between project completion time and project cost.⁷

CPM is adept at handling activity cost variability with respect to normal activity versus “crash” activity duration. An activity is considered to be crashed when its duration has been minimized as a result of applying additional resources e.g. people,

machines, or overtime. Using CPM, one can calculate a deterministic range of dates based upon the level of money that will be spent on “crashing” or reducing the activity durations. CPM allows an analyst to determine optimal use of resources with respect to various completion dates. However, CPM techniques and methodologies do not allow for consideration of the stochastic nature of activity durations and project completion dates.

PERT

Malcolm et al (1959) described the basics of PERT as well as its development history. PERT (Program Evaluation and Review Technique) was developed by a joint government/industry team consisting of the U.S. Navy, Lockheed Aircraft Corporation, and the consulting firm of Booz, Allen & Hamilton. Malcolm et al (1959) described the basics of PERT as well as its development history. PERT was developed in support of the Navy’s Polaris project—an effort to build the first submarine launched nuclear armed ballistic missile. The Polaris project consisted of 250 prime contractors and approximately 9,000 subcontractors. According to the Navy, through using PERT, the Polaris project was completed two years ahead of the original estimated schedule completion date.^{8 9}

Sapolsky (1972), however, writes that there was internal resistance to using PERT, that it was used by only a small portion of the Polaris team, and that its main

benefit was in the manipulation of external stakeholders. The senior leadership of the Polaris program made a point to advertise the development and use of PERT. The publicly held appearance that the Polaris program was being managed with a modern management methodology i.e. PERT was beneficial in deflecting micromanagement attempts coming from higher Naval headquarters and Congress.

Levin and Kirkpatrick (1966) have indicated that a forerunner of PERT may have been Gantt's milestone charts. The networks that formed the basis of PERT represented a considerable improvement upon Gantt charts. PERT networks could show more of the interrelationships, were more adept at supporting large and complicated projects, and employed probability theory when specifying task durations and overall project completion.¹⁰

Activity Duration Specification

A fundamental premise of PERT is that when specifying activity i.e. task durations, only estimates can be provided, typically because the specific activity has not been done before. Note that PERT was developed for a research and development project in which much of the work was new. Consequently, Malcolm et al (1959) established a process by which competent engineers responsible for the specific activity would provide estimates for activity durations in the form of the most likely, most optimistic, and most pessimistic duration. PERT typically utilizes the notation of a

(optimistic), b (pessimistic), and m (most likely). This practice was intended to “disassociate the engineer from his built-in knowledge of the existing schedule and to provide more information concerning the inherent difficulties and variability in the activity being estimated” (Malcolm et al, 1959).¹¹ The expected activity duration (Te) is derived by using the weighted average method calculation shown in Equation 1.

$$T_e = (a + 4m + b)/6 \quad (\text{Equation 1})$$

This method was based upon a decision by the developers of PERT that the beta distribution was most appropriated for specifying the range of uncertainty with task durations. It was also assumed that the distance between the most optimistic and pessimistic duration estimates would equate to 6 standard deviations. Standard deviations, based upon this assumption, can be calculated for each estimated task duration in accordance with Equation 2.

$$\text{Standard Deviation} = (a + b)/6 \quad (\text{Equation 2})$$

The expected project completion date is given by the Te calculation and then the standard deviation can be applied to it to create a normal curve.

Levin and Kirkpatrick (1966) noted that the need to use the single value of the weighted average came about because PERT could not deal with continuous distributions or even only three different times simultaneously. They also stated that in PERT, ‘a

probability of .6 or better of finishing on time is considered good.”¹²

It is also noteworthy that the three estimate basis for activity durations has proved difficult in practice. For example, in the early 1960s NASA used PERT but abandoned the utilization of three estimates (Morris 1997).

Estimating Project Completion Times

PERT provides for the capability to estimate a project's completion time distribution function. However, that estimate is based upon simplifying assumptions that may not be warranted for the particular project. Additionally, the PERT estimate is known to be biased optimistically.

After a PERT network of a project has been created, an expected completion date can be calculated by summing the weighted averages for each of the project activities along the critical path. With this method, the stochastic nature of project completion time is essentially reduced to a deterministic estimate. However, it is possible to create a standard normal curve about the calculated project completion date by summing the activity standard deviations. This implies that projects will have an equal probability for completing before or after the calculated completion date. For most projects, however, it is far easier for projects to be delayed than it is for them to be completed early.

The PERT method is also subject to a “merge-event bias problem,” whereby project completion times are underestimated. Following the introduction of PERT in the

late 1950s, it was soon recognized that the PERT methodology for determining the completion time distribution function of a project was biased optimistically because of a number of issues. MacCrimmon and Ryanec (1962 and 1965) discussed these bias causing factors, which included the use of the Beta distribution for activity durations, the methodology for calculating activity duration mean and variance, the assumed independence of activities, and assumption that the completion time for the project is normally distributed. For projects having multiple paths, with one being identified as the critical path and several other paths being identified as non-critical, there was some probability that one of the non-critical paths would grow to become the critical path. This probability increased when non-critical paths were close to being critical. Ultimately, the issue of PERT providing optimistic completion time estimates became known as the 'merge-event bias problem' or the 'PERT problem'.

Beginning in the early 1960s several methods for mitigating the merge-event bias problem have been studied. One of these has been Monte Carlo simulation. Van Slyke (1963) showed that Monte Carlo techniques could be used to analyze PERT networks. He noted that with Monte Carlo there was great flexibility in that any distribution could be used for the activity durations. More importantly, he showed that these techniques provided an accurate and unbiased estimate of the mean duration of a project. Van Slyke also considered the issue of the project-duration cumulative distribution function (c.d.f.).

In the 1963 time frame, excessive time was required to generate random numbers for Monte Carlo analysis. To reduce this problem, Van Slyke suggested that one discard activities that are rarely or never on the critical path. In that way the size of the model

can be reduced. To go along with this technique, he suggested two heuristic methods to identify such non-critical activities.

In the first method—min-max path deletion—one sets all the activity durations at their minimum and then identifies the critical path. All activities not on the critical path then have their durations set to the maximum. All the paths, and their corresponding activities, that do not take longer than the critical path can be discarded from the analysis because they can never be on the critical path. In the second method—statistical path deletion—one models the entire network, and then runs a “relatively view” initial set of replications. All activities that were not on the critical path in any of these initial replications are eliminated. The simulation is then run for a full set of replications.

Cook and Jennings (1979) added a third heuristic method, called dynamic shut-off in order to further increase simulation efficiency by reducing the total number of replications required. “After each one hundred iterations the cumulative density function of project completion time is compared to the c.d.f from one hundred iterations earlier. If, using a standard Kolmogorov-Smirnov test, there is no significant difference between two successive c.d.f’s at the 0.05 level, the simulation terminates.” Note that Cook and Jennings concluded after comparing the three heuristics that path deletion methods provided the most benefit.

Because modern Discrete Event Simulation running on modern desktop computers has such increased computational speed, the necessity to identify non-critical tasks through the methods proposed by Van Slyke and Cook/Jennings has been reduced.

Researchers have also proposed non-Monte Carlo techniques for analyzing PERT

networks. Some of these researchers validated their proposed techniques by comparing them to the results of Monte Carlo simulation. All of these techniques are limited to acyclic networks in which there are no resource-constraints.

Martin (1965) proposed a generic method for transforming a directed acyclic network to series-parallel form so as to accommodate series-parallel reduction to a single polynomial that represents the time through the network. The advantageous to this approach is that it provides accuracy that is only limited by the approximation of activity durations with polynomials. However, Robillard and Trahan (1977) noted that a drawback is the large amount of calculation required to implement the method.

Hartley and Wortham (1966) presented integral operators for non-crossed networks and those containing a Wheatstone bridge. Ringer (1969) developed integral operators for more complex crossed networks—networks that could be described as containing double Wheatstone bridges or crisscross network.

Lower and or Upper Bound Analysis has been used to estimate the completion time distribution of PERT networks. Kleindorfer (1971) used distributions to bound the activity completion distribution function. Robillard and Trahan (1977) developed a method by which one uses a lower bound approximation. Dodin (1985) further developed techniques to reduce PERT networks to a single equivalent activity and to then estimate the bounds of the completion distribution.

Sculli (1983) proposed an approximation algorithm based on the assumptions that the activity durations are normally distributed and the paths in the network are independent. Kamburoski built upon Sculli's work by adding upper and lower bounds.

Adlakha and Kulkarni (1989) published a classified bibliography of research on stochastic PERT networks. Of particular interest to stochastic PERT networks were the distribution of the project completion time along with the mean and variance of the completion time. Also of interest were the criticality indexes for any particular path or activity. The bibliography was organized into sections including exact analysis, approximation and bounds, and Monte Carlo sampling.

Precedence Diagramming

John W. Fondahl of Stanford University, in doing research for the Navy Bureau of Yards and Docks developed precedence matrices, along with lag values, for projects (Fondahl 1961). He also developed and advocated the use of activity on circle a.k.a. node notation rather than activity on arrow notation for network development. Creation of activity on node networks was found to be faster, less prone to error, and easier to revise than activity on arrow diagrams (Fondahl 1962). Fondahl is largely credited with the development of Precedence Diagramming (Morris, 1997).

Merging of PERT, CPM, and Precedence Diagramming

In 1964 Moder and Phillips published *Project Management with CPM and PERT*. This book, and its subsequent editions, is the standard textbook for project network

scheduling (Morris 1994, 1997). Moder and Phillips recognized the similarities between CPM and PERT with respect to the creation of a project network. Both CPM and PERT methodologies started with a high level Gantt chart, then developed more detailed bar charts for lower level activities, and finally created project network diagrams to indicate activity relationships. Moder and Phillips described the generic network component of CPM and PERT as being represented by 'activity on arrow' since both represented activities by arrows. The difference between CPM and PERT, with respect to activity durations i.e. deterministic versus stochastic, was a function of the information their developers had. In the projects of interest to Du Pont, there was a relatively good understanding of how long activities could be expected to take because similar activities had been done in the past. Whereas, the content and duration of activities was not well understood for Navy's research, development, and activation program to develop the first ever submarine based ICBM. The merging of PERT and CPM into PERT/CPM was enabled with the assumption that either stochastic or deterministic inputs can be used for activity durations.

The subsequent merging of PERT/CPM with Precedence Diagramming is related to the change from activity on arrow to the 'activity on node' convention of Precedence Diagramming. Showing complex project activity relationships is easier with the activity on node convention. In 1965, Engineering News Record reported that private industry was shifting to Precedence Diagramming. By the later half of the 1970s, Morris (1994, 1997) indicates that Activity on Node became more popular than the original PERT/CPM convention of Activity on Arrow. Signifying the merging of PERT/CPM with

Precedence Diagramming, in 1983 Moder and Phillips incorporated Precedence Diagramming into the title of their third edition—*Project Management with CPM, PERT, and Precedence Diagramming*.

Performance Measurement and Earned Value

In 1963 Brigadier General Phillips developed a simple project tracking metric for PERT/COST that was part of his Minuteman Contractor Performance Measurement System (Morris, 1997). This metric, which was a comparison of the actual versus planned progress, was known as the Earned Value system. This system developed the measures of Budgeted Cost of Work Scheduled (BCWS), Budgeted Cost of Work Performed (BCWP), and Actual Cost of Work Performed (ACWP). These measures can be used to estimate in a deterministic fashion when a project is likely to finish and how much it will ultimately cost. Performance Measurement is often used synonymously with Earned Value (Morris, 1997).

GERT and Q-GERT

Pritsker (1966) developed the Graphical Evaluation and Review Technique (GERT) technique for analyzing stochastic networks (Pritsker 1966, 1968). Supporting Pritsker in the development of GERT were Happ and Whitehouse (Pritsker and Happ

1966; Pritsker and Whitehouse 1966). In PERT and CPM all branches of the network are performed during the project. However, in GERT probabilities could be assigned to the various branches in order to indicate that branches might or might not actually be performed during the project. GERT also allowed for looping back in a project network so as to repeat earlier activities. Activity durations were not limited to deterministic estimates (CPM) or the beta distribution (PERT), but could instead be represented by continuous or discrete variables.

Analysis of the network proceeded by first determining the Moment Generating Function (M.G.F) of the activity duration variables. The MGFs for each activity duration were then multiplied by the probability of occurrence of that activity. This multiplication provided a “w” function that formed a system of linear independent equations that could then be reduced to one equation. As originally presented, the GERT procedure could be used to determine the mean and variance of the time to complete a network. The completion time distribution function could be determined by Monte Carlo simulation. It was noted that further work was required in order to be able to determine confidence intervals.

GERT was subsequently enhanced with a cost processing module (Arisawa and Elmahgraby 1972) and the ability to model resource constraints (Hebert 1975). In 1977 Pritsker’s book *Modeling and Analysis using Q-GERT Networks* presented the updated version of GERT that contained these and other improvements.

After its development and through the 1980s, GERT was not widely used (Morris, 1997). This was due to the computational complexities, high costs, and the limited

performance of computers. In the 1990s, advances in statistics and improved desktop computing powers resulted in increased interest in risk analysis that is enabled by probabilistic network schedules as provided by GERT.

VERT

Venture Evaluation and Review Technique (VERT) was developed to assess risks involved with new ventures. Moeller (1972) introduced VERT and it was later updated by Moeller and Digman (1981) along with Lee, Moeller, and Digman (1982). VERT is similar to PERT/CPM in that it is structured as a network. However, each activity is characterized by costs incurred and performance generated in addition to time consumed. VERT was based upon the thinking that there is a relationship between time, cost, and performance. With VERT, a manager could obtain a more integrated analysis of a venture or project. Thirteen statistical distributions, including uniform, triangular, normal, and lognormal, are available for direct use in VERT. There is also a histogram input capability for other distributions. Analysis of a VERT network is done via simulation. Information on completion time, cost, and performance can thus be obtained. For example, distributions for completion time and completion cost are produced.

The VERT method was found to provide accurate estimates of time required to complete projects (Kidd, 1987). Kidd advocated the use of VERT by project managers. He noted that the creating the VERT based model of the project would be time

consuming, but that the resultant ability through the simulation process to pose ‘what-if’ questions would be beneficial. However, VERT has not become a widely used tool like PERT/CPM. It is used even less often than GERT (Morris 1994, 1997).

The Project Management Institute

In 1969 the Project Management Institute (PMI) was founded by a group of project managers in the United States. PMI is dedicated to providing global leadership in developing standards for the practice of project management. This institute has over 100,000 members worldwide. PMI publishes three periodicals—*PM Network* (a monthly magazine), *Project Management Journal* (a quarterly journal), and *PMI Today* (a monthly newsletter). The Project Management Institute also publishes the PMBOK® Guide (*A Guide to the Project Management Body of Knowledge*). As the title implies, this book covers a wide variety of topics pertaining to project management.

Chapter 6—project time management—addresses activities including their definition, sequencing and duration estimating, along with the topics of schedule development and control. Precedence Diagramming Method (PDM), which is also called Activity-On-Arrow (AOA), is presented as the method for activity sequencing. The diagrams created by PDM are commonly called PERT charts. “Finish-to-Start” is the recommended precedence relationship for project activities. According to that relationship, a successor activity starts immediately following the completion of the predecessor activity. The PMBOK® Guide notes that PDM does not allow loops or

conditional branching. GERT and System Dynamics models are listed as examples of project network diagramming tools that allow loops.

Forrester (1961) described System Dynamics and its development in the late 1950s. System Dynamics is a simulation approach to modeling complex problems. Forrester defined it as “the study of the information-feedback characteristics of industrial activity to show how organization structure, amplification and time delays interact to influence the success of the enterprise.” Sterman (1992) states that System Dynamics is widely used in project management. Howick (2002) describes its frequent use to support litigation ensuing from large projects that have time and cost overruns. However, the fact that System Dynamics receives no mention in Morris’s book on the Management of Project suggests that System Dynamics is not a main stream project management tool on par with PERT/CPM.

Activity duration estimates according to the PMBOK® Guide are based upon project scope and resources, and are typically provided by those most familiar with the specific activity. Relevant historical information is often available from previous project files, commercial databases, and the memories of project team members. The latter source is said to be “far less reliable” than documented results. Along with historical information, expert judgment, analogous estimating, and quantitative (rate based) calculations methods are recommended.

The PMBOK® Guide also states that reserve time (a.k.a. contingency or buffer) may be added into the activity duration or elsewhere in the project network. No quantitative guidance is provided for how big the reserve should be.

CPM, GERT, and PERT are listed as the most widely used mathematical analysis tools for supporting the schedule development process. The PMBOK® Guide acknowledges that these tools do not consider resources.

Under the heading of resource leveling heuristics, critical chain is mentioned as “a technique that modifies the project schedule to account for limited resources.”

Simulation is described as a tool for analyzing project schedules and alternatives. According to PMBOK, the most common simulation technique is Monte Carlo Analysis.

Critical Chain Project Management

Goldratt (1997) proposed new project management methods in his “business novel” *Critical Chain*. He noted that the current project management methods and tools were ineffective in keeping projects on time and within budget. A common problem was found to be uncertainty—‘uncertainties embedded in projects are the major causes of mismanagement.’¹³ The new methods proposed by Goldratt were in part an extension of his earlier work on the Theory of Constraints (TOC), which had been described in his 1984 book titled *The Goal*. Under the tenets of TOC, a production system is limited by a constraint i.e. a bottleneck. In order to maximize system output a feeding buffer is placed in front of the bottleneck so that the bottleneck is continuously operating to full capacity. The rate at which the bottleneck can operate represents the drumbeat to which the rest of the system operates. As applied to project management, the constraint or bottleneck is analogous to the critical path. Additionally, however, the critical path must take into

account the added constraint of critical resources. When resources are taken into account, the critical path may change. This is called the critical chain.

Interestingly, Goldratt noted that the lateness of a project could be far more financially devastating to a company than the project's financial overrun. The reason for this was revenues, or payback, from the project are delayed and potentially reduced or even eliminated by the project being late. Consequently, the Critical Chain methods tend to be focused on improving project completion timeliness.

The Critical Chain methods for project management included identifying the true critical path i.e. the critical chain, which includes resource considerations, and strategically placing safety time in the project network. These strategic locations are at the end of the project, called a "project buffer," and at nodes, called "feeding buffers," where non-critical activities feed into the critical chain. Goldratt also stresses limiting safety time in all other areas. Because of the relationship between theory of constraints and the critical chain methods the new project management methods have become known synonymously as either Theory of Constraints Project Management or Critical Chain Project Management (CCPM).

Since 1997, the topic of Critical Chain Project Management a.k.a. Theory of Constraints Project Management, has been the subject of papers presented at conferences, papers published in journals, and books. Elton and Roe (1998) reviewed Critical Chain for *Harvard Business Review*. They gave the concepts good marks for individual projects, especially those involved with developing new products. However, they felt Goldratt had not fully extended the Theory of Constraints to companies managing

multiple projects. Newbold (1998) and Leach (2000) each authored books on Critical Chain. Leach suggests that CCPM is essentially a result of synthesizing Total Quality Management (TQM), Theory of Constraints, and the Project Management Body of Knowledge (PMBOK®). Jacob and McClelland (2001) provide an introduction into the basics of Theory of Constraints Project Management. At the Project Management Institute Annual Seminars and Symposium in 2000, the Critical Chain Project Management methodology was called “one of today’s hottest and most controversial methodologies to come out in a long time” (Leigh, Givens, Filiatrault, and Peterson 2000). Ning, Jianhua, and Yeo (2000) proposed that Supply Chain and Critical Chain concepts be combined to manage procurement uncertainties in Design (Engineering), Procurement, and Construction (EPC) projects. Hagemann (2001) discussed the results of using the Critical Chain Project Management technique at the NASA Langley Research Center. CCPM was used at Langley beginning in 1999 in the hopes that wind tunnel testing productivity could be improved. The results were successful enough such that other organizations within Langley have asked to be trained in how to implement CCPM.

A summary of the details of the Critical Chain methods proposed by Goldratt and extended by other researchers is presented below.

Activity Embedded Safety Time

Goldratt described how people generally deal with the uncertainties with estimated activity duration and project durations. Individuals charged with estimating activities typically pad their estimates with safety time so as to be able to have an 80 to 90 percent chance of completing their assigned activities on time. Figure 4 shows a conceptual activity duration distribution function along with the approximate location of the 80-90th percentile. A significant problem with this planning dynamic is that safety time is spread throughout the project rather than being concentrated in the areas that need it the most.

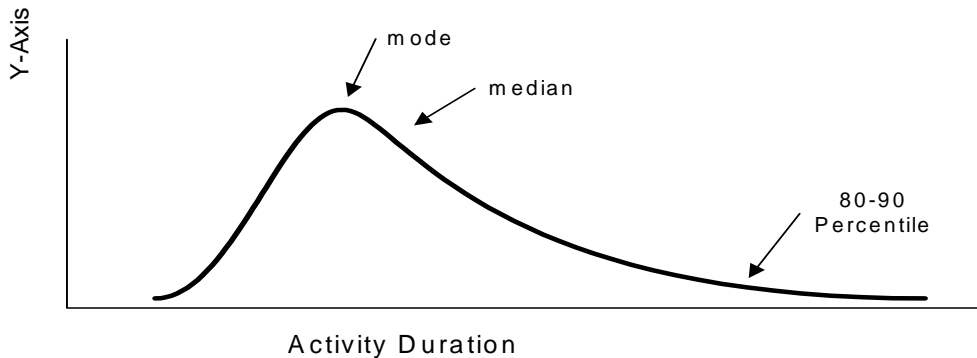

Figure 4: Activity Duration Distribution Function

Despite the presence of large amounts of safety time embedded within individual tasks, these tasks can still finish late. Consider the following situation with a project activity. This particular activity duration is actually 3 days assuming all goes well. The schedule allows 15 days for the work to be done, based upon the padded estimates. Knowing the existence of the pad, the manager waits until the last 3 days to start. Goldratt calls this the “student syndrome” because students have a tendency to wait to the last minute to study for an examination. If the activity experiences problems, then the project schedule is impacted.

In making their estimates, Goldratt also noted that the practice of multitasking causes activities to take longer. Additionally, the knowledge that multitasking exists in the workplace is taken into consideration when making estimates. An illustration of the impacts of multitasking is seen in Figure 5.

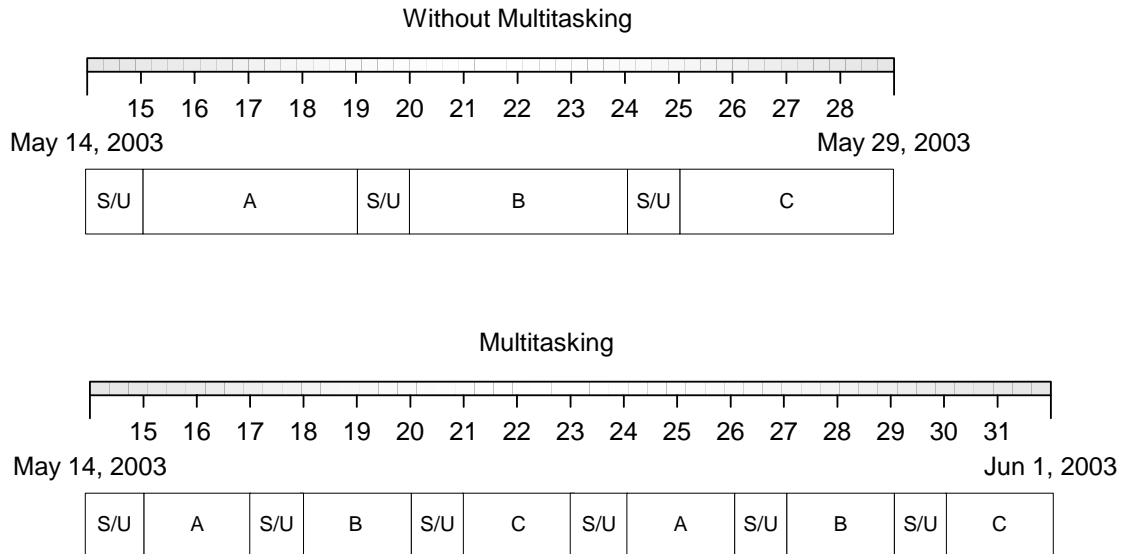

Figure 5: Multitasking Increases Task Durations

In Figure 5 there are three tasks each requiring four days of work separated by 1 day of setup time. In the absence of multitasking, Task A completes on May 19, Task B on May 24, and task C on May 29. Multitasking causes Task A completion to be delayed until May 26, Task B to May 29, and Task C to June 1. Perhaps more significant, however, is the influence on task duration. Each task has grown in total duration, setup to finish, from 5 days to 12 days. If the impacts of multitasking are considered when making activity duration estimates, then the overall project duration may well be much longer than actually required.

Another typical project management dynamic identified by Goldratt is that predecessor activities that finish early typically do not result in the follow on activity starting early. This means that most of the embedded safety time tends to be wasted.

Newbold (1998) provides guidance on estimating activity durations. Estimates should be based upon dedicated workers, having required resources, and with no multitasking. The average duration for an activity should be the baseline estimate. Thus 50 percent of the time the activity will take longer than planned. Subsequent buffers, either feeding or project, are in place to absorb activities that take longer than average.

Project and Feeding Buffers

Goldratt's proposed solution for improving project completion timeliness includes removing most of the safety time from the individual activities. This can result in a dramatic reduction to the overall project duration. To account for uncertainty so as to ensure a reasonable chance of completing the project on time, safety time is then strategically placed in the project in so called feeding and project buffers.

Feeding buffers consisting of safety time or management reserve are placed where non critical activities feed into the critical chain. Perhaps the more important place for safety time is at the end of the critical chain, which also represents the end of the project. This safety time is called the project buffer.

Newbold (1998) discusses the issue of sizing the project buffer and identifies two "very approximate" methods. The first method is called a rule of thumb, which is to set it at 50 percent of the unpadded critical chain duration. This rule is said to be adequate for most projects. The second approach, which is more scientific according to Newbold, is

provided by Tony Rizzo of Lucent Technologies. In this method one aggregates the risk along the chain feeding the buffer. This is done by first estimating the 90 percentile worst case (w_i) and the average duration (a_i) for each activity. The difference between w_i and a_i is thus about two standard deviations, assuming a standard normal distribution. Assuming that one desires approximately 90 percent assurance, or two standard deviations of protection, then the buffer should be sized in accordance with Equation 3.

$$\begin{aligned} \text{Buffer} &= 2 \times \sigma \\ &= 2 \times \sqrt{((w_1 - a_1) / 2)^2 + ((w_2 - a_2) / 2)^2 + \dots + ((w_n - a_n) / 2)^2} \quad (\text{Eq. 3}) \end{aligned}$$

Yongyi Shou and Yeo (2000) considered the question of how to estimate the proper size for the project buffers. They interpreted Goldratt's method as making the buffers equal to one-half the duration of the path they are intended to protect. They suggest instead a two step process to calculate a more appropriate buffer size. The first step is to categorize the activities into four categories (A-D) according to the activity's level of uncertainty. Category A represents very low uncertainty, B low uncertainty, C for high uncertainty, and D for very high uncertainty. The next step is to ascertain the risk attitude or desired safety level of the decision maker. The risk attitude level is divided into three levels—low, median, and high. These levels appear to be analogous to one, two, and three sigma respectively. The buffers sizes proposed by Yongyi Shou and Yeo are shown in Table 1.

Table 1: Buffer Sizes as Proposed by Yongyi Shou and Yeo

Uncertainty Category	Low Safety (68%)	Median Safety (95%)	High Safety (99.7%)
A: Very Low	4%	8%	12%
B: Low	12%	24%	36%
C: High	20%	40%	60%
D: Very High	28%	57%	85%

Leigh, Givens, Filiatrault, and Peterson (2000) performed a broad review of CCPM, which included a recommendation for how to size the buffers. Their recommendation was to employ the four components of the risk management process as described by the PMBOK guide. These components were to identify the risk driving the contingency, incorporate that risk into the project’s risk management system, quantify that risk, and develop a risk response plan. The stated benefits of following those components were that unknown-unknowns would be reduced, the size of the project buffer could thus be reduced, the risk to the project is being dealt with in an open manner, and the stakeholders are better assured that the project buffer is appropriately sized.

CCPM on Project Completion Time Distribution Function

Despite the emphasis of critical chain on recognizing and mitigating project uncertainty, the Critical Chain literature does not appear to recommend the use of Project Completion Time Distribution functions.

Newbold (1998) identifies three data elements that should be monitored in each section of project's network schedule that contains a buffer. These are the current task, the amount of buffer that is still available, and the remaining duration of the chain of tasks feeding that buffer. Newbold suggests that projects managers have sufficient experience and intuition to judge if the remaining buffer is large enough to cover the risk associated with the remaining tasks. Newbold does not present any material on quantitative risk analysis measures such as completion time distribution functions.

Leach (2000) categorized risk assessments as being either quantitative or qualitative. Examples of quantitative risk assessment tools were failure modes and effects analysis (FMEA), Monte Carlo analysis, project simulation, PERT, probabilistic safety assessments (PSA), and management oversight or risk tree (MORT). Leach discounts these quantitative tools stating, "I focus on qualitative risk assessment because the data usually are not available to justify quantitative risk assessment; and supplying numbers tends to yield a false sense of believability."¹⁴ Leach does not cover the topic of Completion Time Distribution Functions. Instead, monitoring and managing the buffers—the project buffer and the feeding buffers—is the recommended method for ensuring that the project completes on time.

Empirical Data for Input Analysis

In any simulation model the input that goes into it is critically important. For the particular application described in the following chapters a primary interest is in the

inputs for project activity durations and project event probabilities. The literature indicates that whenever possible such inputs should be based upon empirical evidence. Law and Kelton (2000) state that, “it is imperative to collect data on a random variable of interest if at all possible.” They identify three methods for using existing data to describe process durations in simulation models. In the first method—direct use of historical data—the data values themselves are used in the simulation. In this technique, when an entity begins a process, the duration of that process is determined by selecting a duration from the historical data. In the second method, the historical data is used to define an empirical distribution. In the third and generally preferred method, a theoretical distribution is fitted to the historical data. It is their experience that using triangular or beta distributions to approximate an unknown distribution can cause large errors.

It is true that projects do contain new elements (activities and events that have not been done before). In those cases, it is still important to rely on related empirical data. Law and Kelton indicate that if the only available data is from a legacy system [one could easily substitute the word project in place of system], then it is imperative that one make maximum utilization of that data. Pegdon, Shannon, and Sadowski (1995) on the other hand recommend caution on the subject of using data from a similar existing system when modeling a non-existent system. Similarity may stem from a new system being a variant of an older system. They note that inferences from such systems are risky and that the ability to test validity may be limited.

In the situation where empirical data is not available, textbooks recommend that you seek the opinions of subject matter experts for the process being modeled. Pegdon,

Shannon, and Sadowski note that there are dangers in relying upon subject matter experts for estimates. They reference the research of Tversky and Kahneman (1974). These researchers found that even people highly familiar with activities can be very poor at estimating. Extreme cases are typically forgotten, and recent events are overemphasized.

Pegdon, Shannon, and Sadowski suggest four sources for parameter estimates in the absence of empirical data. These are operator estimates, designer estimates, vendor claims, and theoretical considerations. Problems with operator estimates have been discussed above. Designer estimates are typically optimistic in that the designer typically expects that his/her system will operate as designed and per specification. Likewise, vendor claims are likely to be optimistic. Two examples of theoretical considerations are how inter-arrival times tend to follow the exponential distribution and how the mean time between electronic equipment failures typically follows a Weibull distribution.

Another factor to consider when modeling and managing a project is workforce behavior. Gutierrez and Kouvelis (1991) state that classical PERT/CPM methods do not take into consideration work force behavior, which may cause or contribute to project delays. They cite Parkinson's Law—"work expands so as to fill the time available for its completion"—as being a factor in how long projects take.

Chapter 11 of the PMBOK covers project risk management. Six major processes are associated with a project risk management system. These are Risk Management Planning, Risk Identification, Qualitative Risk Analysis, Quantitative Risk Analysis, Risk Response Planning, and Risk Monitoring and Control. Historical information is listed as one of four inputs to identifying project risks.

CHAPTER THREE: METHODOLOGY

This chapter consists of two parts. In part 1, the Project Assessment by Simulation Technique is described in detail. In part 2, the case study methodology as it pertains to using PAST in a real world project management environment is described.

Part I: The Project Assessment by Simulation Technique (PAST)

The overarching goal of the Project Assessment by Simulation Technique (PAST) is to provide project stakeholders with a visual display of project completion risk and thereby enable them to respond as appropriate so as to improve project completion performance. The visual display is in the form of a Project Completion Distribution Function (PCDF) overlaid with the planned project completion date (Figure 6).

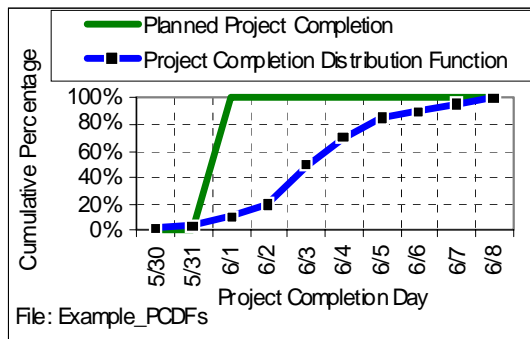

Figure 6: Visual Display of Project Completion Risk (Example)

The PCDF is produced via a simulation model of the project's schedule. Deterministic inputs for the simulation model are taken directly from the project's schedule. These inputs can include planned project activity durations, available project margin time, precedence requirements, and resource requirements. The stochastic inputs for the simulation include activity duration growth and event probabilities. These stochastic inputs are determined based upon analysis of past similar projects. A simplified overview of the PAST methodology is shown in Figure 7.

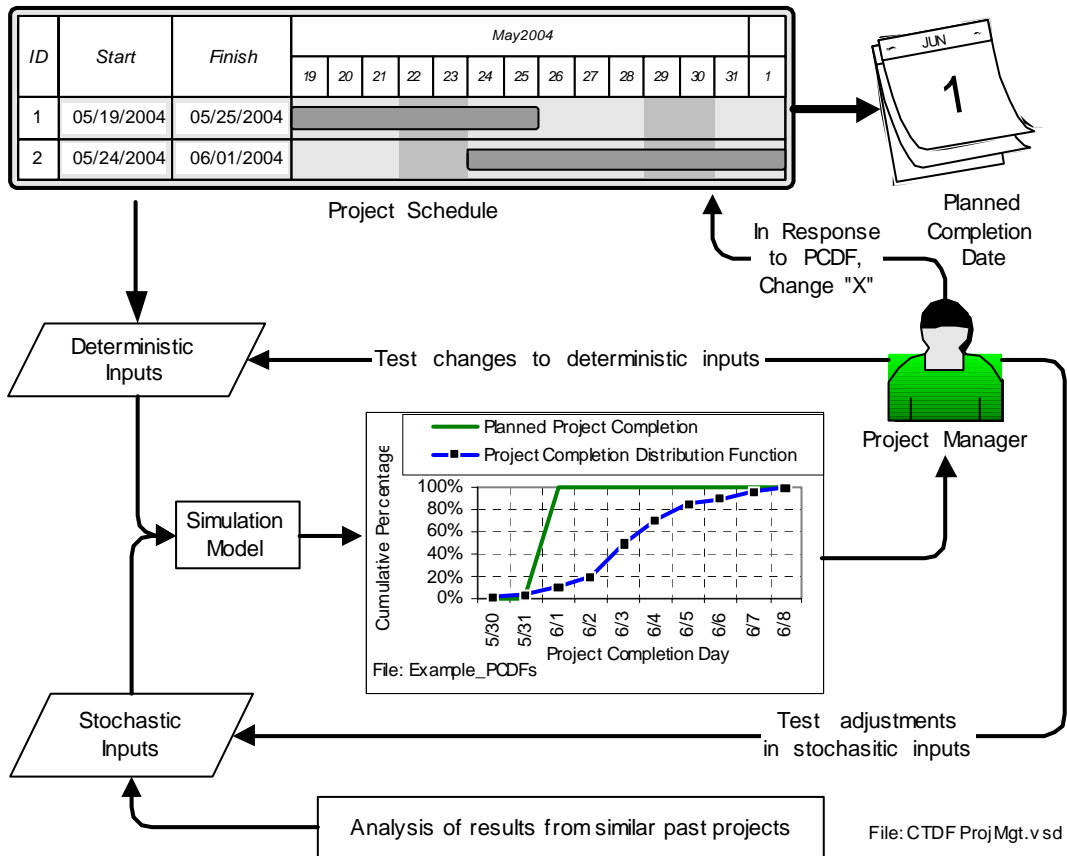
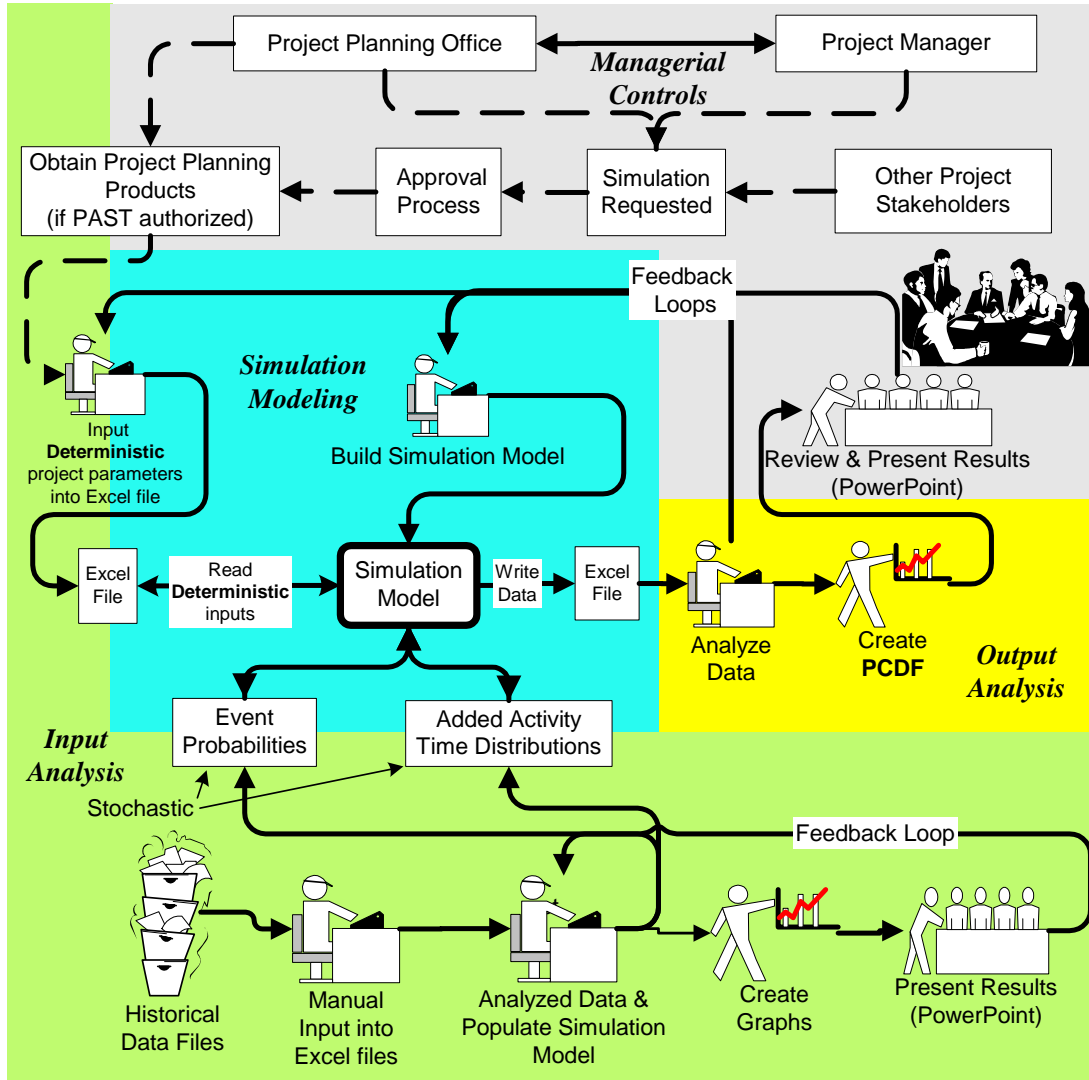

Figure 7: Overview of the PAST Methodology

A more detailed working level view of the four major components of PAST is presented in Figure 8. These components consist of Managerial Controls, Simulation Modeling, Input Analysis, and Output Analysis.



Project Analysis Process R1.vsd

Figure 8: PAST Flow Diagram

Each component of PAST is described in greater detail in the following sections.

Managerial Controls Component of PAST

The primary purpose of the managerial controls component is to provide a facilitating interface between those performing the Project Assessment by Simulation Technique and the multitude of diverse project stakeholders including, project planners, managers, budgeters, and customers. A PAST activity can be thought of as having three phases, (1) introduction of PAST and obtaining concurrence to perform the assessment, (2) performing the assessment, and (3) providing the results. Managerial controls will vary depending upon which phase you are in.

During the first phase emphasis is placed upon explaining the Project Assessment by Simulation Technique to project stakeholders. This is necessary for gaining approval to perform the assessment and to obtain project stakeholder assistance for the work to be done. Success in this phase also lays the foundation for later project stakeholder acceptance of the assessment results. The managerial controls to be abided by while performing the simulation and when providing the results should also be discussed and agreed to up front.

Project stakeholders will generally have a keen interest in project completion timeliness. The stakeholders have diverse frames of reference. These include those that are charged with ensuring that the project completes on time along with those that are

depending upon the project to complete on time. Consequently, an analysis of a project's completion risk has the potential of becoming contentious or even controversial.

In light of this potential, it is not a good strategy to show up uninvited to a project, build a simulation model, and proceed to inform project stakeholders that their project has little to no chance of completing on time. Doing so is likely to result in a rather harsh rebuke of an otherwise well intended product. Hands-on learning of this lesson can be avoided by having a strategy for working with and for project stakeholders and putting in place agreed to managerial controls.

Introductory Briefings

The first step in the managerial controls component of PAST is to introduce the project manager, the project planning office, or other project stakeholders to the PAST methodology and secure sponsorship for a PAST based analysis of the targeted project. Figure 7 and Figure 8 can be used in these introductory meetings to provide an overview of the PAST methodology. Examples of analyses from previous similar projects should be shown. If this is a first time analysis for the analyst, then a notional sample analysis could be created. The introduction can be given either in a briefing to a group or in less formal meetings with key individuals.

The hoped for outcome of these briefings or meetings is that at least some project stakeholders will be willing to sponsor an assessment of the project using PAST.

Assessment Requirements

After permission has been granted to perform a PAST based project assessment, the various requirements for the analysis should be discussed and agreed upon. First there will be a need to have access to the existing project schedule. An understanding of major assumptions within that schedule or likely alternative schedules of interest should be acquired as well. If the effort will also include an analysis of past historical data, then access to that data will need to be established. Expectations for when the first PCDF is to be provided should be established. There should also be preliminary discussions concerning follow-on analysis effort for the inevitable what-if questions that will occur in response to the initial PCDF.

The specificity of the assessment requirements may vary depending upon the situation. For example, an in-house effort would likely requires less concrete specifics than an analysis that would be the result of a contractual arrangement. Additionally, specificity will probably increase with experience on the part of both the analyst and the sponsor.

Communications

It is critically important to establish clear communication norms early in the analysis. An area of great concern will likely be the issue of who will be privy to the resulting assessment and any potential recommendations. One strategy would be to brief

the sponsor in a private setting and then let the sponsor decide if further communications with a wider audience are warranted. This strategy seems appropriate when there is a strong sponsor or a contractual arrangement.

The situation may be more complex in the case of an in-house analysis done by a lower tier organization or in the absence of a sponsor in a position of power. In that case careful thought should be given to which stakeholders to share the assessment results with so as to build support for the analysis.

Simulation Modeling Component of PAST

The simulation modeling component of PAST contains multiple subcomponents. These include a simulation engine with modeling constructs uniquely tailored for the PAST methodology, an input file that contains the deterministic information from the project being modeled, and an output file for writing the simulation produced project completion dates to. The modeling component processes and entities are shown in the shaded area of Figure 9.

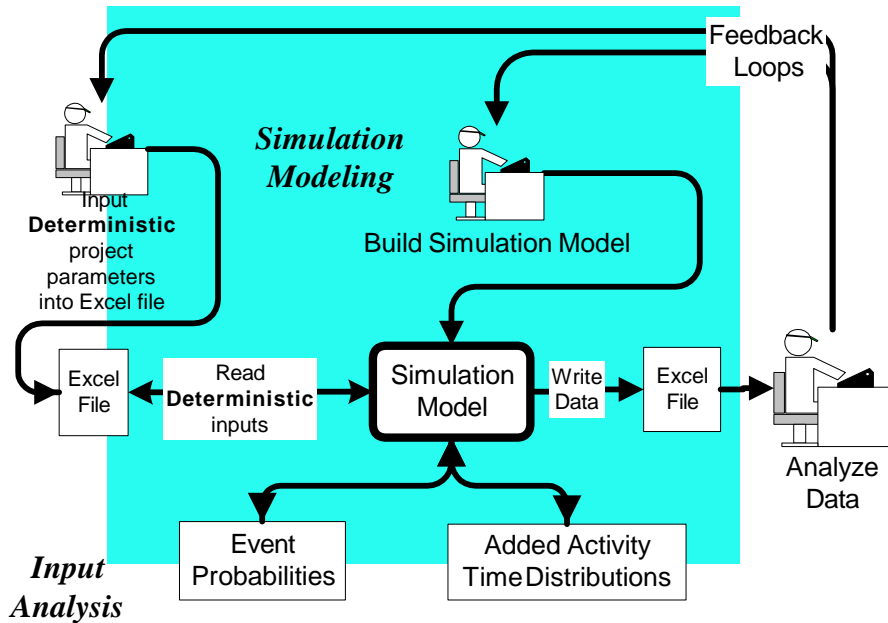

Figure 9: Simulation Modeling Component

The simulation modeling component uses Discrete Event Simulation (DES) as the underlying engine for modeling projects and developing the Project Completion Distribution Functions (PCDF). DES is ideally suited to this task because it is based upon the Monte Carlo type simulation that has been used in the past to provide accurate and unbiased stochastic analysis of project completion dates for PERT/CPM networks. DES easily handles a wide range of deterministic and stochastic inputs and has sufficient modeling flexibility to model project schedules. With DES software the project modeler is not constrained to the modeling constructs of PERT, CPM, or even the more capable Q-GERT. Instead the modeler has great flexibility to model the project in a manner that is most similar to the way in which the project manager is managing the project.

There are other practical reasons for why DES was considered as being an attractive alternative to PERT/CPM. Commercially available DES software operates efficiently in a desktop computer environment, and at prices ranging in the thousands of dollars, such software is available for most companies. A wide range of projects, from small to very large and complex, can be modeled. DES is also adept at modeling resources such as people, material, machinery, or facilities that constrain many, if not most or all, projects.

The simulation model is built by the analyst and is specific to the project being analyzed. That model reads the project's deterministic inputs from an Excel file. Stochastic parameters, which come from the input analysis process, are entered directly into the model. The model may also include the capability, as required, to accommodate various assumptions of interest to the project stakeholder. The output of the simulation model is written into an Excel file that is used for later analysis.

Note that the PAST methodology is intended to be consistent with the norms for conducting Discrete Event Simulation modeling. While these norms include guidelines for conducting input analysis and output analysis, these two subjects are discussed later in their own separate sections.

PAST models are similar to the precedence diagram networks developed by PERT/CPM, GERT, and VERT, along with the capabilities inherent to discrete event simulation software. In support of the PAST methodology three project network modeling constructs are presented. These are an activity construct, a probabilistic event construct, and a cyclical construct. These constructs contain logical operators that

provide modeling complexity and fidelity beyond PERT/CPM. Event probability nodes allow one to model unplanned but not unpredictable event occurrences that necessitate additional activities in the project. Cyclical constructs allow the modeling of projects that have at least some cyclical activities. Note that the PERT/CPM methods were developed primarily for acyclic or once through projects. Event nodes and cyclical constructs have been used in GERT and VERT. The most unique modeling construct of the PAST methodology is the activity construct. The rationale for creating the constructs is to enable the modeling of real world projects and project management environments.

Activity Construct

The level of detail in which the project is being managed is an important consideration with respect to the activity construct. For example, consider the case of a very large project in which there are thousands of activities. No single project manager can be effective in managing all of the activities. One method to handle such an overwhelming situation is to group the activities so as to create lower-level projects that when combined make up the entire project. Lower-level project managers, who report to the overarching project manager, are assigned to manage each of the lower-level projects. The activity construct assumes such a situation. Consequently, each “activity” construct actually represents a lower-level project that feeds into the overall project.

The activity construct is structured such that it allows the overarching project

manager to specify the planned or target duration for an activity—the lower level project. The unit of time is days. The construct accommodates the reality that such activities don't necessarily go according to plan. It specifically considers the possibility that predecessor activities may be late, resources may be unavailable, and once the activity does get started, it may take longer than planned. The construct also provides the overarching project manager with the ability to give schedule reserve to the lower-level manager for that manager's use in completing the activity on schedule.

In PERT, an activity's duration is established by an analyst estimating the most optimistic, most likely, and most pessimistic times. For example, in a PERT network an activity might have a duration of 8, 10, and 15 days, which represent the optimistic, likely, and pessimistic estimates by the analyst. These three estimates are then used to calculate an expected time for the activity.

In the PAST methodology the activity duration is initially specified deterministically. The stochastic elements along with the precedence and resource requirements are added later. For the deterministic component, the activity duration is based upon a realistic assessment of what the activity should reasonably take, plus a deterministic amount of margin time (this is a key component of the management control mechanism). Figure 10 shows how this would look.

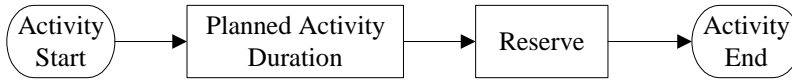

Figure 10: Activity Modeling Construct with Deterministic Duration and Reserve

A potential process for specifying the activity duration is illustrated by the following example. Suppose a task is planned to be accomplished in 10 days (analogous to optimistic time a) and that the project manager has allotted an additional 2 days of margin time to account for potential problems. Thus total available time is 12 days to complete the task. The actual duration of the task will ultimately be 10 days plus whatever additional days are required as a result of problems encountered. So long as these additional days are 2 or fewer days, then the task will complete on schedule. However, if greater than 2 added days are required, then the task will complete late.

In other words, in the proposed construct, activity durations are established in a way that is fundamentally different than PERT in that they are established through a different management dynamic. This dynamic is that an overarching manager provides or dictates the duration for an activity. The dictated duration should, however, be based upon an intelligent assessment of what the duration should be i.e. the duration is reasonable and achievable assuming things go well.

An important assumption of PAST is that actual activity durations are positively correlated to planned activity durations. This assumption should be tested during the review of past similar project activities.

In order to account for the probabilistic likelihood that the duration will increase, some amount of reserve time may be added to the planned duration. Ideally the amount of reserve provided should be adequate such that not too little or too much reserve is provided.

In order to provide the activity construct with stochastic capability a block is added such that it is in parallel with the reserve block. This is where the distribution for how much added activity time is required to complete the activity. Figure 11 shows how this looks.

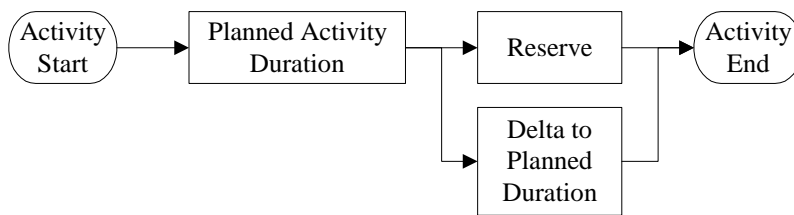

Figure 11: Activity Modeling Construct with Stochastic Duration Added

The introduction of the stochastic element into the activity construct is based upon empirical data from performance on similar or like prior tasks. This technique provides a number of benefits. For example, weaknesses in having people estimate a, b, and m for the activity duration have been noted in the literature. People tend to forget most of history and focus instead on the most recent events. There is a strong tendency to pad estimates. Use of an empirical distribution will provide more varied and thus more

accurate distribution shapes than beta distributions. Additionally, empirical distributions may be easier for managers to understand, especially if the distributions are from historical events that the managers are familiar with.

The manner in which the deterministic/stochastic construct shown in Figure 11 would behave is illustrated with the following example. Recall the three duration values of the PERT example previously described i.e. 8, 10, and 15. The corresponding values in the proposed activity construct could for example be 8 in the planned activity duration block, 2 in the reserve block, and an empirical distribution with an average of 2 and ranging from 0 as the minimum to 7 as the maximum. Given an added constraint such that the activity cannot finish ahead of its planned completion date, then the activity would end after a duration of 8 plus the longest path of either the management reserve or the delta to planned duration.

The assumption that an activity cannot finish ahead of its planned completion date is essentially the same as saying that the follow-on activity is constrained such that it cannot start early. There are two reasons for invoking such a constraint. The first is that it simplifies the modeling constructs. The second and more important reason is that in real projects it is often the case that activities, particularly in large complex projects, cannot be started early. For example there may be some unique resource that will not be made available until that date. Similarly, the start date for the activity may be contingent upon a contract start date. Likewise, consider a commercial aircraft and its planned departure time. An early departure is typically not allowed, either because the need to ensure that all passengers have an opportunity to make the flight, or because the flight

plan specifies a takeoff time so as to smooth integration into air traffic control. In the case of a space launch, the opening of the launch window may be constrained such that it cannot be moved up. This is typically true when the vehicle being launched is going to rendezvous with either another spacecraft or a planetary body.

We continue now with development of the activity construct. If a subsequent activity starts late relative to its planned start date, then the reserve within that activity would in essence be automatically used by the project manager so as to maintain that activity's completion date. Figure 12 shows the Activity Modeling Construct with the addition of the reserve reduction feature.

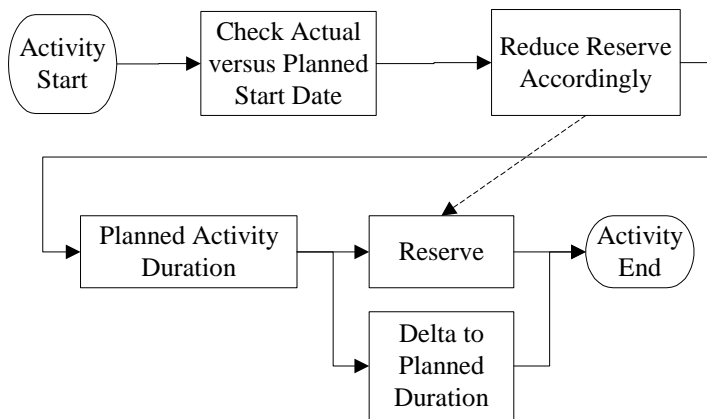

Figure 12: Reserve Reduction Feature Added to Activity Construct

The next thing to add to the activity construct is the resource required for the activity. Before the activity can begin, any required resource must be acquired and made

ready. In DES terminology this is called seizing a resource. Figure 13 shows the activity construct now that the resource requirement has been added.

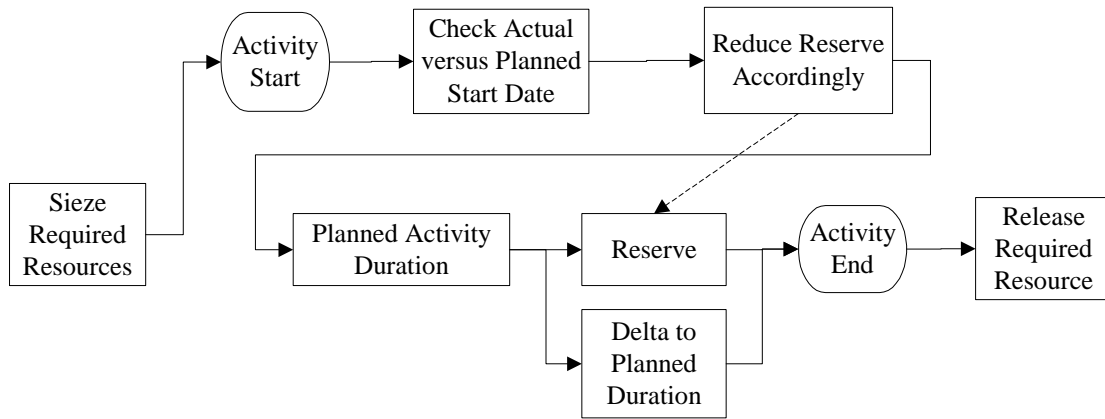

Figure 13: Resource Element Added to Activity Construct

The final item required to complete the activity construct is a block to indicate completion of the predecessor activities. Figure 14 shows the complete notional activity construct.

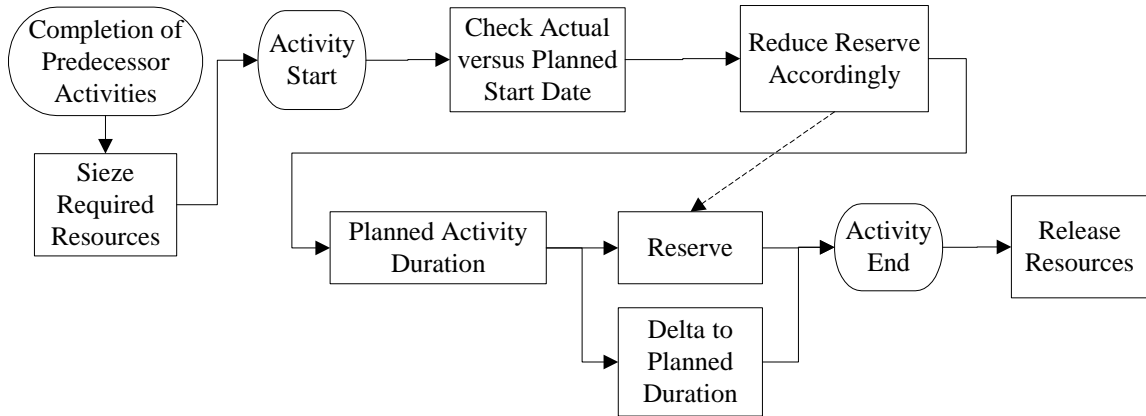

Figure 14: Completed Activity Construct

The above technique has the following benefits. The use of one value for the deterministic duration is simpler than making three estimates. The technique allows the overarching project manager to avoid padding of activity durations by analysts or lower-level managers. The addition of a deterministic amount of margin time provides the project manager with a control mechanism. Another benefit is that after a simulation model of the project has been built, validation is simplified by the use of deterministic values. For example, by setting the stochastic added duration to zero, and assuming availability of resources, then the simulation should end exactly on the planned project completion date. This builds confidence and acceptance of the model.

Probabilistic Event Construct

Some, if not all, projects are subject to the occurrence of unplanned—and most likely undesirable—but not unpredictable events. The occurrence of these events can necessitate additional activities or lengthen an already planned activity. For example, during a construction project when the foundation is being established, severe rain may occur such that water has to be pumped out of the area before work can restart. Another example might be an increase to a transportation time. Consider the case illustrated in Figure 15. At the conclusion of the last activity at Site A (a fabrication site), the project entity, which might be a major component of a bridge, is transported to Site B where final assembly will occur.

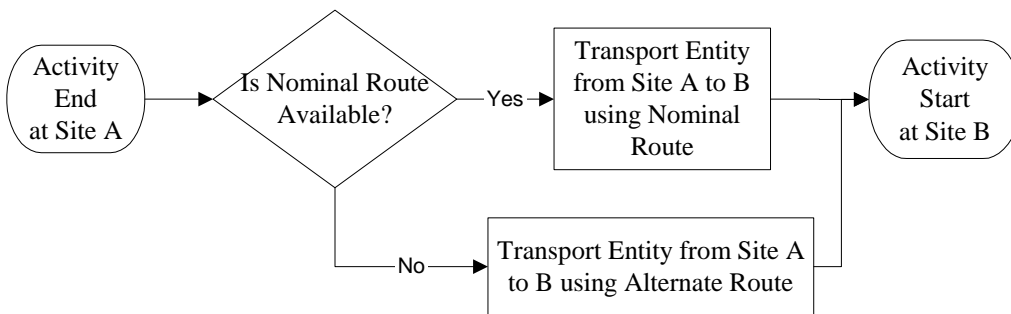

Figure 15: Predictable Need to Use an Alternate Route

Given a situation in which the nominal route is traveled, there is likely to be a standard time of transportation subject to a known distribution for traffic delays.

However, if for some reason an alternate route is required, then the standard time will be completely different and most likely significantly longer. Likewise the distribution of traffic delays for the alternate route will likely be different as well.

Cyclical Element Construct

The mainstream project scheduling tools such as PERT/CPM are limited to non-cyclical projects. With DES, as with GERT, projects having cyclical elements can be modeled. One example of a cyclical process is a final inspection of a new house, whereby items failing inspection have to undergo rework before a follow-up inspection can be performed. This is illustrated in Figure 16. Cyclical processes like these are easily implemented in DES.

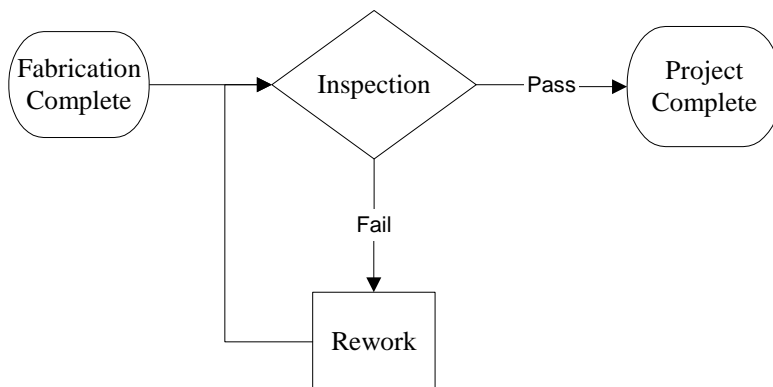

Figure 16: Cyclical Process

Input Analysis Component of PAST

The input analysis component of PAST includes both deterministic and stochastic features. Figure 17 shows how the activity construct requires both deterministic and stochastic inputs.

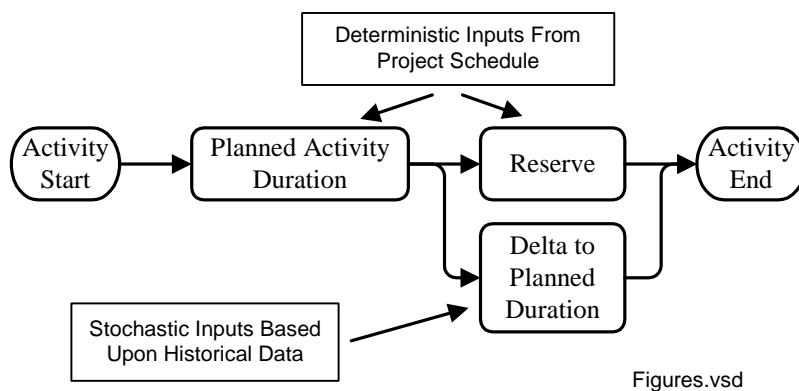

Figure 17: Input Analysis for Activity Construct

The planned activity duration and schedule reserve, if any, for an activity is taken from the project schedule as deterministic values. The stochastic feature of the activity construct is applied to the delta to planned duration. This value is an empirical distribution based upon historical activity duration growth for similar activities. In the absence of historical data, it could be represented using alternative methods such as a triangular distribution derived from expert opinion.

Since the modeling constructs are created such that they are compatible with

specific project environments, so too the input analysis required for populating those constructs with the appropriate stochastic inputs e.g. probability distributions for added activity durations and event probabilities must be based on considerable awareness of the specific project environment being modeled. For that analysis, empirical information will be used to the greatest extent possible. Figure 18 shows the overall process for conducting the input analysis.

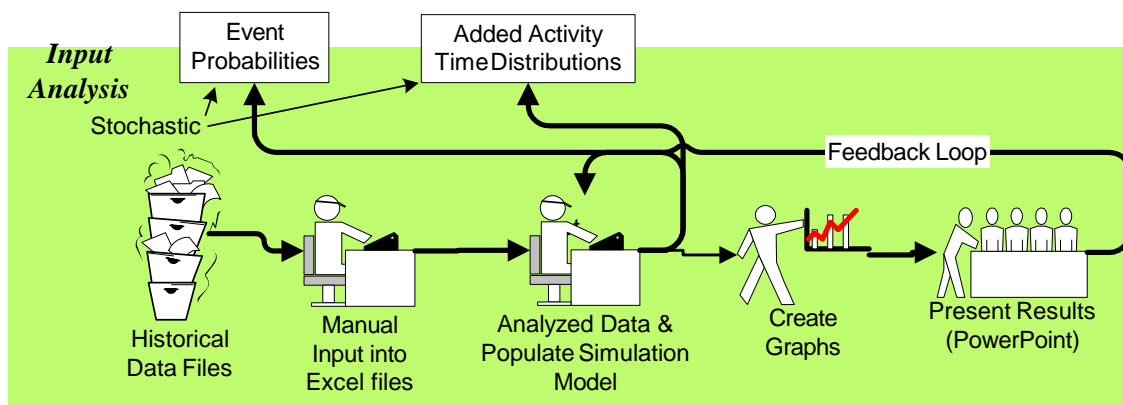

Figure 18: Input Analysis Component of PAST

The first step in the process is to decide what data is required and then obtain access to the historical files containing that data. Historical data on previous events of interest will be required. Likewise, data on planned versus actual durations will for project activities will be required.

Since historical files may only be available in hardcopy a step for manually entering the data into Excel is shown.

Once the data is entered into Excel it can be analyzed either within Excel or copied into other software tools such as ExpertFit. The analysis process typically includes the creation of run charts, outlier analysis, and the creation of histograms and cumulative frequency distributions. This process results in the production of the stochastic inputs—event probabilities and added activity duration distributions—for the project simulation model. Event probabilities, such as the probability of a primary transportation route being available or the likelihood of an inspection failure, can be based upon the percentage of time that the event has occurred in the past. Modifications of this probability can be made during the modeling phase in order to understand the sensitivity of this factor. A relative simple comparison of the delta between planned versus actual duration allows one to generate an empirical distribution for the Added Activity Time Distributions. If there is enough information, a theoretical distribution may be used, providing the appropriate goodness-of-fit tests are satisfied. For this research, empirical distributions were used.

All inputs should be shared with the appropriate project stakeholders so as to obtain their feedback and concurrence. This step will help to build validity into the model.

The input analysis phase can also be used to assist the project planners and project manager determine planned duration for project activities. Recall that in the previous section it was stated that the duration should be reasonable and achievable assuming most things go well. How does one go about making that determination? Perhaps the best way is to make the determination based upon empirical information. For example in the past,

this same activity or similar activity has taken so much time. The selected duration might be the minimum duration or alternatively the average duration from the historical data base. Ultimately, however, the planned duration will be the decision of the overarching project manager. Nonetheless, it will still be important to show how the planned duration compares to the historical data base.

Similarly, the historical information can provide insight into the how much activity reserve should be provided for any given project activity. Just like the selected activity duration, the overarching project manager will make the final determination as to what quantity of reserve will be allotted to the lower-level managers. Ideally, the reserve should be adequate such that not too little or too much reserve is provided. Three issues will be addressed when considering the amount of reserve to be imbedded. The first is the distribution for how much added time will be required to complete the task over and above what was planned for the task. The second is the potential lateness of the predecessor tasks, and the third is the potential unavailability of resources.

An area of interest for this research is the influence of schedule reserve on the project completion distribution function. For example, the strategy of Critical Chain Project Management is to not imbed schedule reserve in individual activities, but instead place it at the end of the project in a “project buffer” and also at places called “feeding buffers” where non-critical chains feed into the critical path. The project modeling constructs proposed by this research enable some exploration of the project buffer strategy.

Output Analysis Component of PAST

The output analysis component consists of the functions necessary to analyze the simulation supplied results, create project completion distribution functions, and present the relevant information to project stakeholders. If the validity is questioned, feedback loops allows the project simulation model to be modified. Once validated, at least in the eyes of the analyst, the results are then shared with the selected project stakeholders consistent with the agreed to managerial controls. Feedback from this group is anticipated and accommodated as required. Figure 19 illustrates the process.

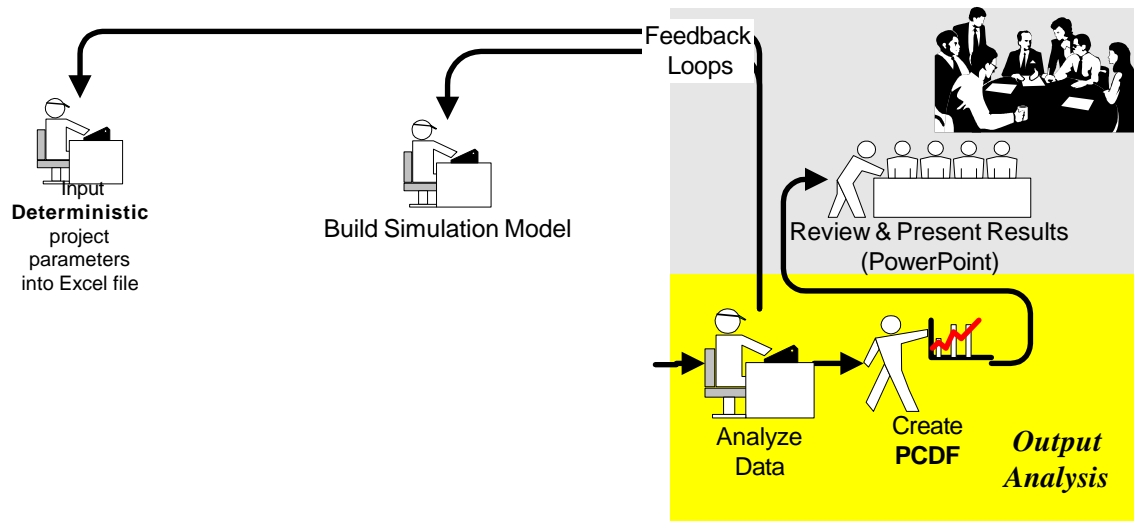

Figure 19: Output Analysis Component of PAST

Determining the PCDF using a simulation model is a straight forward process. Note first that the modeling of a project using DES is a terminating simulation in which

the duration between the start of the simulation and the end of the simulation, or some other measured milestone in the simulation, represents the project duration. Since each replication of the simulation begins with a new stream of random numbers which are IID (independent and identically distributed) each replication is independent and produces an unbiased observation on the desired response i.e. the project completion dates.

Creating the PCDF

The output of the simulation, in this case the simulation completion date for each replication, is entered into an Excel worksheet. Once the data is in Excel all the required calculations to determine the PCDF can be done. Ultimately, a cumulative frequency distribution of the completion dates is produced. It is also desirable to show a histogram of the data. Figure 20 shows a possible way in which one might present those results. The cumulative frequency distribution represents the estimate of the PCDF.

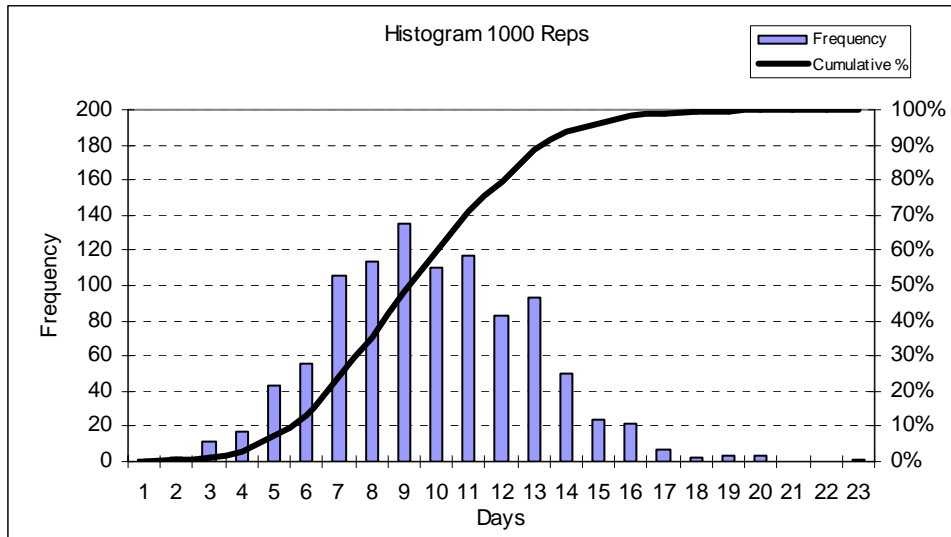

Figure 20: Presentation of a Project Completion Time Density Function

Determining the PCDF Confidence Band

The next step is to calculate a confidence band about this estimate. Unfortunately, this is somewhat problematic. The problem stems from the PCDF being a distribution or density function as opposed to a single number. The typical response of a discrete event simulation is a single number e.g. an average activity duration. Consider the data in Figure 20. The mean completion day is 9.825. Or in other words, 50 percent of the time the project completes within 9.825 days and 50 percent of the time it takes longer. However, because this mean is calculated from 1000 simulation replications, which essentially represent samples from a population, what we should really provide is a confidence interval for when the project will complete 50 percent of the time.

Equation 4 shows the Law and Kelton (2000) recommended equation for calculating the confidence interval for a mean from the data supplied by a simulation. Applying this equation to the data that went into Figure 20 yields a 95 percent confidence interval that spans from 9.634 to 10.016.

$$\bar{X}_{(n)} = \pm t_{n-1, 1-\frac{\alpha}{2}} \sqrt{\frac{S^2(n)}{n}} \quad (\text{Equation 4})$$

where:

$\bar{X}_{(n)}$ = the mean of the sample of size n

$t_{n-1, 1-\frac{\alpha}{2}}$ = the Student t value for n-1, 1- $\alpha/2$

α = the desired level of confidence

S^2 = the sample variance

Determining the confidence band along the entire PCDF, as opposed to a mean completion date, requires additional work. For that we must perform Equation 4 for each day that the project might complete. This method is explained using the data from Figure 20. The data from the 1000 replications is divided into 10 sets of 100 replications. Consequently the value of n is now 10 instead of 1,000. Note that what the number of replications and sets should be will depend upon the specific project and desired level of accuracy. Once the data has been divided into the desired number of sets, a cumulative frequency distribution is calculated for each of the sets. For each day that the project

might complete by, i.e. from 1 to 23 days, a mean and 95 percent confidence band is created. Table 2 shows how this is set up using Excel. Figure 21 shows a graphical representation of the confidence band.

Table 2: Confidence Band Calculation

Day	Confidence Interval					SQRT of Sample Var / Var/N	Sample N	Sample Variance	Completion Day Probabilities of each Sample											
	Upper	Average	Lower	Half Width	t value				1st 100	2nd 100	3rd 100	4th 100	5th 100	6th 100	7th 100	8th 100	9th 100	10th 100		
1	0.003	0.001	0.000	0.002	2.262	0.001	0.0000	0.0000	0.00	0.00	0.00	0.00	0.01	0.00	0.00	0.00	0.00	0.00	0.00	0.00
2	0.006	0.003	0.000	0.003	2.262	0.002	0.0000	0.0000	0.01	0.00	0.00	0.01	0.01	0.00	0.00	0.00	0.00	0.00	0.00	0.00
3	0.019	0.014	0.009	0.005	2.262	0.002	0.0000	0.0000	0.02	0.01	0.01	0.01	0.02	0.02	0.00	0.01	0.02	0.02	0.02	0.02
4	0.040	0.031	0.022	0.009	2.262	0.004	0.0000	0.0002	0.03	0.04	0.03	0.04	0.03	0.04	0.00	0.04	0.04	0.04	0.04	0.02
5	0.088	0.074	0.060	0.014	2.262	0.006	0.0000	0.0004	0.07	0.10	0.07	0.10	0.10	0.05	0.06	0.08	0.06	0.06	0.05	
6	0.142	0.130	0.118	0.012	2.262	0.005	0.0000	0.0003	0.14	0.14	0.12	0.15	0.14	0.13	0.09	0.13	0.12	0.14		
7	0.259	0.236	0.213	0.023	2.262	0.010	0.0001	0.0010	0.29	0.26	0.22	0.27	0.25	0.22	0.18	0.22	0.22	0.23		
8	0.368	0.350	0.332	0.018	2.262	0.008	0.0001	0.0006	0.38	0.35	0.34	0.39	0.35	0.35	0.33	0.36	0.30	0.35		
9	0.519	0.485	0.451	0.034	2.262	0.015	0.0002	0.0023	0.58	0.46	0.48	0.54	0.48	0.44	0.47	0.50	0.49	0.41		
10	0.635	0.595	0.555	0.040	2.262	0.018	0.0003	0.0032	0.66	0.59	0.56	0.67	0.60	0.57	0.60	0.63	0.60	0.47		
11	0.733	0.712	0.691	0.021	2.262	0.009	0.0001	0.0009	0.78	0.70	0.70	0.73	0.70	0.71	0.67	0.71	0.73	0.69		
12	0.814	0.795	0.776	0.019	2.262	0.008	0.0001	0.0007	0.83	0.78	0.75	0.77	0.81	0.77	0.79	0.82	0.81	0.82		
13	0.909	0.888	0.867	0.021	2.262	0.009	0.0001	0.0009	0.93	0.87	0.83	0.93	0.89	0.88	0.88	0.87	0.90	0.90		
14	0.954	0.938	0.922	0.016	2.262	0.007	0.0001	0.0005	0.97	0.93	0.90	0.94	0.95	0.94	0.91	0.94	0.97	0.93		
15	0.977	0.962	0.947	0.015	2.262	0.007	0.0000	0.0005	0.98	0.93	0.94	0.99	0.98	0.96	0.93	0.97	0.97	0.97		
16	0.994	0.984	0.974	0.010	2.262	0.005	0.0000	0.0002	0.98	0.97	0.96	1.00	1.00	0.98	0.97	0.99	0.99	1.00		
17	0.999	0.991	0.983	0.008	2.262	0.003	0.0000	0.0001	0.99	0.98	0.97	1.00	1.00	0.99	0.98	1.00	1.00	1.00		
18	0.999	0.993	0.987	0.006	2.262	0.003	0.0000	0.0001	0.99	0.98	0.98	1.00	1.00	0.99	0.99	1.00	1.00	1.00		
19	1.000	0.996	0.992	0.004	2.262	0.002	0.0000	0.0000	0.99	0.99	0.99	1.00	1.00	0.99	1.00	1.00	1.00	1.00		
20	1.000	0.999	0.997	0.002	2.262	0.001	0.0000	0.0000	1.00	1.00	0.99	1.00	1.00	1.00	1.00	1.00	1.00	1.00		
21	1.000	0.999	0.997	0.002	2.262	0.001	0.0000	0.0000	1.00	1.00	0.99	1.00	1.00	1.00	1.00	1.00	1.00	1.00		
22	1.000	0.999	0.997	0.002	2.262	0.001	0.0000	0.0000	1.00	1.00	0.99	1.00	1.00	1.00	1.00	1.00	1.00	1.00		
23	1.000	1.000	1.000	0.000	2.262	0.000	0.0000	0.0000	1.00	1.00	1.00	1.00	1.00	1.00	1.00	1.00	1.00	1.00		

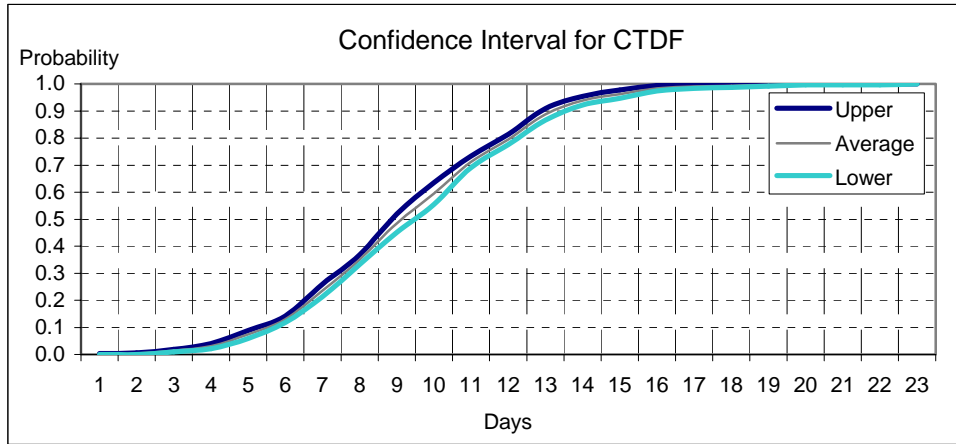

Figure 21: Graphical Presentation of Confidence Band

A fundamental assumption in the above discussion of the confidence band for the PCDF is that the various activity duration estimates and event probabilities within the project are valid. For projects in which there is a sufficient amount of empirical data this will generally be the case. However, when modeling a project for which there is not sufficient empirical data, this assumption will not be valid. For those cases it would be important to perform sensitivity analysis on the various estimates of activity durations and event probabilities.

Automation of these steps is desirable because project stakeholders have a tendency to request repeated simulations using alternative assumptions or inputs. Automation helps to reduce the analysis time such that analysis products are provided in a timely basis.

Verification and Validation for PAST

Following the creation and population of a typical DES model, the next step is to verify and validate the model. Verification deals with building the model right, whereas validation deals with building the right model.¹⁵ Verification is the process of determining whether a simulation computer program works as intended i.e. according to the modeling assumptions that were made. This may also be referred to as debugging the computer program. Validation is the process of determining whether the conceptual model is an accurate representation of the actual system being analyzed. This means “ensuring that the model behaves the same as the real world system.”¹⁶

Verification

The Project Assessment by Simulation Technique contains two features that facilitate verification. First of all, the activity constructs are repetitive modules and this improves the ability to write and debug the simulation model of the project incrementally. Secondly, the simulation model is structured such that it allows one to run it in a deterministic mode to ensure that it will produce the planned project completion date. While the ultimate goal is to obtain an output of the project completion date, intermediate project milestones can be compared to expected values to identify where problems in the program occur.

Experts in simulation recommend that simulation builders start with a minimally

detailed model of the project and build upon that as needed. This practice is followed in PAST. Additionally, the stochastic features can be incrementally added-in, and later switched on or off, to see if the influence upon project completion is as expected. Some animation is also recommended so that the analyst can use that animation to verify that entities traverse the network as expected and identify where entities get “hung-up.”

Validation

The primary focus of the validation process is to ascertain if the output of the model—the project completion distribution function—is reasonable in the view of both the analyst and the client. Three primary techniques are used for validation. They are: (1) developing a model with high face validity; (2) testing the assumptions of the model empirically; and (3) testing model output for reasonableness to the actual project being modeled. Each of these three techniques is described in greater detail below.

Face validity for simulation models of projects should inherently be high because we are modeling an existing project plan or PERT/CPM network. Consequently, so long as the model is a reasonable representation of the existing plan, then project stakeholders should be inclined to accept the model. The project manager, the project planning office, or some similar stakeholder provides the project plan that will be modeled. The client (project manager or representative) and other stakeholders are briefed on the methodology to be used to develop the model of the project plan. This briefing includes a description

of the modeling constructs—activity, event, and cyclical—as well as the manner in which historical data is used to determine probability distributions and event probabilities. Past uses of the methodology in similar situations are presented. All modeling assumptions are discussed with the project stakeholders and agreed upon. The desired output performance measures are also determined jointly with the project stakeholders. This early involvement of the project stakeholders helps to ensure that the final model and its output have high face validity. Another tactic for ensuring high face validity will be to see if past projects completed within the PCDFs that would have been predicted had the PAST methodology been used for those projects.

Testing the assumptions of the model empirically is enabled by the fundamental structure of the PAST methodology. For example, in PAST a heavy reliance is placed on using empirical project data to develop empirical distributions for added days in the activity constructs. In classic system simulation modeling, one might fit a theoretical distribution to historical data and then perform goodness of fit tests. In this methodology we are primarily using empirical distributions due to the following important benefits. Face validity is enhanced because project stakeholders are likely to recognize and therefore relate to data from past projects. It is also easier to explain to clients how the simulation model makes use of an empirical distribution versus a theoretical distribution.

Reliance upon empirical distributions can create problems. For example, there may be a lack of data. This problem can be address by soliciting opinions from project stakeholders or individuals deemed by the project stakeholders to be experts. Another problem is that future performance may lie outside the bounds of the historical data. This

problem can be mitigated by running sensitivity analysis e.g. use of theoretical distributions.

The third validation technique is to determine how representative the simulation output is to the actual project being modeled. This technique will start with running the model with all the added activity duration distributions and event probabilities set to zero, and with activities being unconstrained by resources. In that way, if the model accurately reflects the project, then the model will show a completion date exactly on the planned completion date. This step may also be performed as part of the model verification steps. After a successful verification/validation run in the deterministic mode, the model is populated with the added activity duration distributions, event probabilities, and resource constraints. This model is used to produce the PCDF, which is then analyzed for reasonableness. That determination is dependent upon both the analyst and the client accepting the PCDF as reasonable.

Measuring Progress

The project completion distribution function can be updated as the project progresses over time. For example, once a task has been completed, the simulation model of the project can be run from that point forward to the end of the project. An alternative method would be to run the simulation from the project start date, with all completed tasks modeled as constants. Either way, the new distribution function is

created and compared to the previous distribution function. In that way, it is possible to see if the project is improving, staying the same, or getting worse with respect to the likely completion date.

Likewise, as project managers make changes to the project, the model can be updated and a new distribution function created. A comparison can then be made to the old distribution function to see if the changes helped or hurt the distribution function.

Part II: Research Methodology (Case Study)

The next step was to apply the Project Assessment by Simulation Technique described above and see if it is in fact beneficial. To test PAST, one could envision an experimental method in which the dependent variable is project completion timeliness. The independent variable that would be varied would be the management methodology used e.g. with or without PAST. The hypothesis in this hypothetical experiment being that project completion timeliness will be better for projects managed with PAST than without. Unfortunately, setting up such an experiment is difficult and likely to be rather expensive. Therefore, an alternative case study methodology for conducting a preliminary validation of the benefits of PAST was employed. Assuming PAST gains at least preliminary acceptance as a result of those case studies, then the resources and necessary support for the more desired experiment might be obtainable.

For the alternative method, multiple case studies were performed in which the measure of interest was the response of the project stakeholders to the Project

Assessment by Simulation Technique. The case study methodology and how it was employed for this research are described below.

Case Study Definitions

The Project Assessment by Simulation Technique was tested in a real world project management environment using Yin's (2003) case study research design and methods as a general guide. Yin provides a two-part technical definition of a case study. The first is that, "a case study is an empirical inquiry that investigates a contemporary phenomenon within its real-life context, especially when the boundaries between phenomenon and context are not clearly evident." For the case studies described in Chapter 4, the phenomenon was project completion timeliness and the real-life context was the organization implementing and managing the project.

The second part of Yin's definition is that, "the case study inquiry copes with the technically distinctive situation in which there will be many more variables of interest than data points, and as one result relies on multiple sources of evidence, with data needing to converge in a triangulating fashion, and as another result benefits from the prior development of theoretical propositions to guide data collection and analysis." As such, the case study is a comprehensive research strategy that includes study design logic, techniques for data collection, and specifies approaches to data analysis.

Components of Research Design

There are five components to case study research designs. These are: (1) a study's questions; (2) its propositions, if any; (3) its unit(s) of analysis; (4) the logic linking the data to the propositions; and (5) the criteria for interpreting the findings. These components and how they were addressed by the case studies presented in Chapter 4 are discussed below.

Study Question

The case study question of interest was, "How will project stakeholders respond to the Project Assessment by Simulation Technique?" According to Yin, the case study strategy is most likely to be appropriate for addressing "how" questions. Such questions are also explored through experiments. Perhaps more importantly, the case study is advantageous when such a question "is being asked about a contemporary set of events, over which the investigator has little or no control." The only influence that the author had in the studies reported in the next chapter was to provide to project stakeholders either descriptive information on the Project Assessment by Simulation Technique and/or Project Completion Distributions derived from PAST.

Proposition

In a case study the study proposition is analogous to an experiment's hypothesis. The case studies were centered upon using the Project Assessment by Simulation Technique to develop models of various aspects of a large and complex project. The PAST methodology, the models it produces, and the analysis from the models, i.e. the project completion distribution function (PCDF), were presented to various project stakeholders. The proposition was, "Project stakeholders will react positively to the Project Assessment by Simulation Technique and may, in certain situations, take action to improve project completion performance." Of course, it was hoped that project stakeholders would be receptive of the PAST methodology and make use of the information it provides, i.e. the PCDF, to improve project completion performance. For example, consider the scenario depicted by Figure 22.

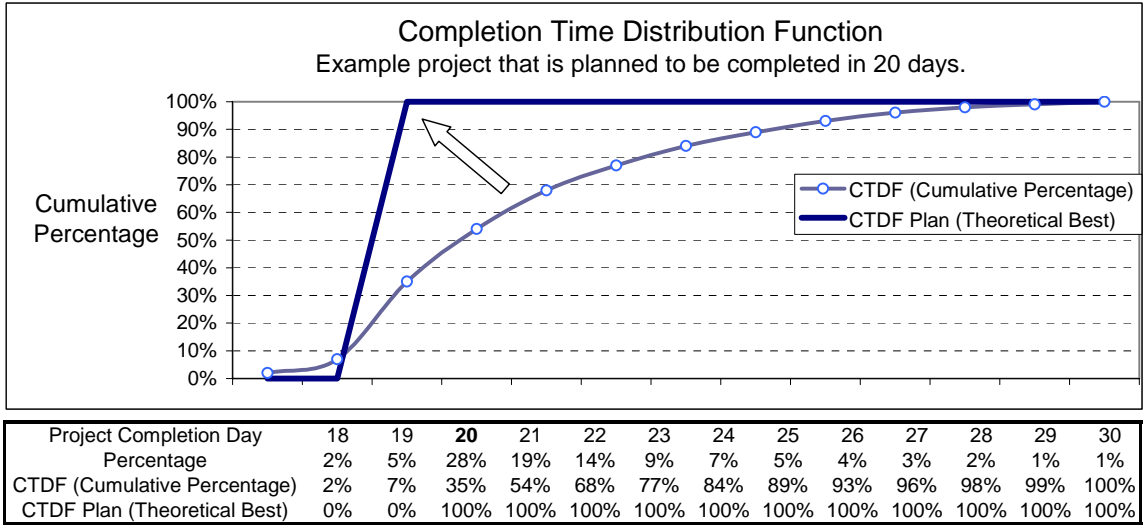

Figure 22: Notional Project Planned Completion Date versus PCDF

Given a PCDF that shows a considerable likelihood of the project being late, would the project stakeholders be motivated to take actions that would likely pull the PCDF in the direction of the arrow—closer to the planned completion date? If stakeholders suggest or take action then the proposition can be answered in the affirmative.

Units of Measurement

The units of measurement for the studies were the project stakeholders. These were typically individuals representing either themselves or the respective project interests of their organization. On occasion, small groups were the unit of measurement.

Note that the actions of specific individuals are not published per se. Instead the collective actions of individuals, organizations, and/or small ad hoc teams observed during each case study are reported in a manner which, while providing accurate information relevant to the case study, avoids identifying specific individuals or work groups. Actions of government officials that have already become public knowledge are presented, but only to place the case studies in their historical context.

Logic for Linking Data to Proposition

The logic for linking the data to the proposition was founded on the data gathered during the case studies. That data was the reactions of the project stakeholders to the Project Assessment by Simulation Technique. The data was captured via direct observation. For some cases a PCDF of a project was simply presented directly to stakeholders. In these cases the PCDF typically indicated that the project was likely to finish much later than planned. The response of the stakeholders to this information was recorded. Additionally, two small ad hoc work groups specifically chartered to analyze a project were introduced to the Project Assessment by Simulation Technique. At the conclusion of the briefing on PAST, they chose to utilize PAST to support their effort. Their subsequent utilization of PAST was observed by direct observation as well.

Criteria for Interpreting the Findings

The criteria for interpreting the findings varied based upon the particulars of the case studies. In some cases the PCDF indicated that the project was likely to complete much later than planned. Examples of positive responses for those types of studies would include project stakeholders requesting alternative assessments under varying assumptions or making actual changes to the project plan, scope, or budget. A negative response would be recorded if the stakeholder did nothing despite the fact that action seemed warranted. For the situation in which PAST was described to the two ad hoc groups and offered as a potential tool, a positive response could be recorded based upon those groups choosing to use PAST.

The potential value of PAST for improving project management will be established if the majority of the case studies have positive responses. The management of the particular projects in the cases under study may in fact benefit from the PAST methodology. However, a generalization that PAST provides universal improvement of project management is beyond the scope of this research. Given the success of the case studies presented in the next chapter, it is nonetheless hoped that stakeholders in other projects will benefit from PAST.

Ensuring Case Study Design Quality

There are four established tests—construct validity, internal validity, external

validity, and reliability—for determining the quality of empirical social research and they are directly applicable to the conduct of case studies. Kidder& Judd (1986) define these tests as follows:

1. Construct validity: Establishing correct operational measures for the concepts being studied.
2. Internal validity: establishing a causal relationship, whereby certain conditions are shown to lead to other conditions, as distinguished from spurious relationships.
3. External validity: establishing the domain to which a study’s findings can be generalized.
4. Reliability: demonstrating that the operations of a study—such as the data collection procedures—can be repeated, with the same results.

How these tests were dealt with during the course of the case studies is described below.

Construct Validity

Yin recommends that case study investigators cover two steps to assist in ensuring that the case study meets construct validity test. The first of these is to “select the specific types of changes that are to be studied (and relate them to the original objectives of the study).” In the case studies shown in Chapter 4 the specific change under study was the

response of the project stakeholders after exposure to the Project Assessment by Simulation Technique.

The second step is to “demonstrate that the selected measures of these changes do indeed reflect the specific types of changes that have been selected.” The selected measures of these changes are the direct observation of the project stakeholders.

Three tactics are described by Yin to increase construct validity.¹⁷ The first of these is to “use multiple sources of evidence.” Six sources of evidence are typically associated with case studies. These are documentation, archival records, interviews, direct observations, participant-observation, and physical artifacts. The case studies shown in Chapter 4 utilized participant-observation as the main source. As a participant-observer, I participated in the projects under study due to my position as a NASA employee. This position afforded considerable access to project stakeholders. As such I was able to introduce the PAST methodology to various project stakeholders and observe their responses. Additionally, I could respond to questions and comments. The potential downside to reliance on this methodology is that of bias. I assumed an advocate role on behalf of the PAST methodology and therefore my observations may contain bias. To mitigate that potential I endeavored to maintain a factual based report of the observations. In addition to participant-observer evidence, the case studies in Chapter 4 also contain documentation sources. These include project plans/schedules and records of communications. These sources help to ensure that the case studies are accurately described and also helped to minimize participant-observer bias.

The second tactic is to “establish a chain of evidence.” The last link in the chain is

the report of the case study itself. While the case studies are directly reported in Chapter 4, the entirety of this document represents that final link. It is the intent of this research that a reader of this document can follow the chain of evidence from the initial research question, through the multiple case studies presented in Chapter 4, and finally to the conclusions presented in Chapter 5.

The chain of evidence was also bolstered by the modern information technology of the Internet, powerful desktop computers, and applications software. For example, much of the communications during the course of the case studies occurred via email. Consequently, that set of case study evidence was well documented and easily sorted either by subject or chronologically. The creation of the Project Completion Distribution Functions for each of the case studies was done via simulation models and Excel files that are maintained in an orderly fashion and can be reviewed by subject or chronologically. The PCDFs were typically presented to project stakeholders in a PowerPoint presentation and these files were also well archived.

The third tactic is to “have key informants review the draft case study report.” The key informants are the project stakeholders that participated in the case study. The intent of the review is to ensure that there is agreement with the facts presented in the report of the studies.

Internal Validity

Yin discusses two threats to internal validity. An example of one of these is that an investigator may incorrectly conclude that event A led to event B, when in fact some other unidentified event caused event B. In that example, the research design failed to account for a threat to internal validity. The second threat to internal validity discussed by Yin focuses on the inferences that an investigator may make when direct observations are not possible. In those cases the investigator may be relying upon historical documentation and interviews collected during the case study. Since the case studies in Chapter 4 relied primarily upon direct observation, both of these threats are mitigated.

External Validity

The question of external validity is whether or not the findings of the case study can be generalized to a larger spectrum. Single case studies are deemed to provide insufficient evidence for making generalized findings. This concern has been addressed in part by conducting multiple case studies over an extended period of time. It is acknowledged, however, that these multiple case studies were related in that the same large organization and large scale project was the subject of all the case studies. Consequently, any generalizations that are made are not for all projects in all environments but are instead appropriately limited to the type of project and project environment observed in the case studies.

Reliability

The test for reliability focused upon the issue of repeatability e.g. ensuring that subsequent researchers would be able to obtain the same results given the same scenario. Consequently, documenting procedures used during the cases study along with minimizing errors and biases during the study were all important for achieving reliability.

The Specific Case Study Design

The research presented in Chapter 4 followed a two-phase approach. First there was a single pilot case study in which a prototype version of PAST was developed and used in response to specific project stakeholders. The lessons learned from this pilot study were then incorporated into a more formalized version of PAST. In the second phase, multiple case studies were conducted in a variety of contextual settings. A chronological overview of the research is depicted in Figure 23.

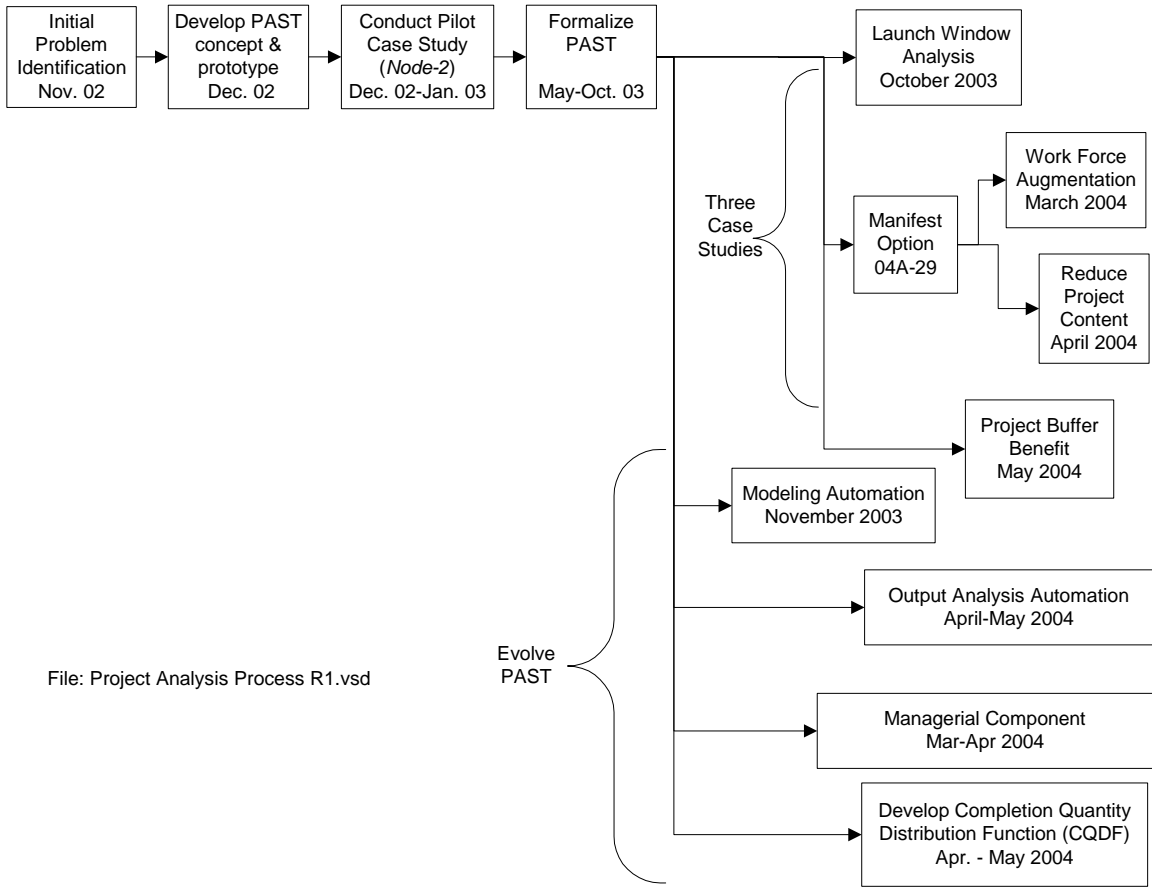

Figure 23: Research Methodology Chronological Overview

These studies were opportunity based in that they were in response to project stakeholder requests. While the research occurred over a period of time of greater than one year, the individual case studies were short lived in nature. Consequently, there was opportunity for PAST to evolve in response to findings from the earlier studies.

CHAPTER FOUR: FINDINGS

The Project Assessment by Simulation Technique was used in support of the on-going project to assemble the International Space Station. This is a large complex project. The critical path to assembling the International Space Station is dominated by the ability of the Space Shuttle to deliver the components of the International Space Station to orbit. Consequently, this aspect of the International Space Station project was modeled and became the central focus of the case studies.

This chapter is divided into three major sections. The pilot case study is presented in the first section. In the second section three additional case studies are presented. The third section describes refinements to PAST that were made along the way.

Section I: The Pilot Case Study

The pilot case study focused on building the International Space Station through an interim milestone known as United States Core Complete. This study originated in December of 2002 during a time period when there was great interest in completing the United States Core portion of the Space Station by February 19, 2004.

Background

Since 1984, NASA had been engaged in a massive project to create the largest and most complex orbiting Space Station ever built. This project included international partners from Russia, Europe, and Japan. The project fell significantly behind schedule and went significantly over budget. In 2001 the project was “on probation” and NASA was pressured to prove that future schedules and budgets could be met. Consequently, a goal was established to complete the United States core portion of the Space Station by February 19, 2004. “If this goal was not met, NASA would risk losing support from the White House and Congress for subsequent Space Station Growth.”¹⁸

By late 2002, the plan to achieve the February 19, 2004 goal was in jeopardy. In December, NASA initiated an assessment to determine how much margin, a.k.a. safety time or slack, was in the processing schedules for each of the seven Space Shuttle missions required to complete the interim milestone of U.S. Core Complete.

To get from December of 2002 to “U.S. Core Complete” by February 19, 2004 would require seven successful Space Shuttle missions. The missions were designated STS-114, 115, 116, 117, 118, 119, and 120. Each mission was unique and the seven missions needed to occur in that precise order. U.S. Core Complete was synonymous with delivery of the Node-2 component to the International Space Station. STS-120 was slated to fly the Node-2 mission. In regard to the order of the missions, the project was similar to the construction of a multiple story building, with the second story needing the first story to be structurally complete and so on.

Three critical resources were required to accomplish the seven missions. These were the three Space Shuttle orbiters—Columbia, Atlantis, and Endeavour—that would perform the assembly missions. The order of the Space Station assembly missions, with respect to the Space Shuttle orbiter that would fly the respective missions, was Atlantis, Endeavor, Atlantis, Endeavour, Columbia, Atlantis, and finally Endeavour. Figure 24 shows this sequencing of the missions on each orbiter graphically.

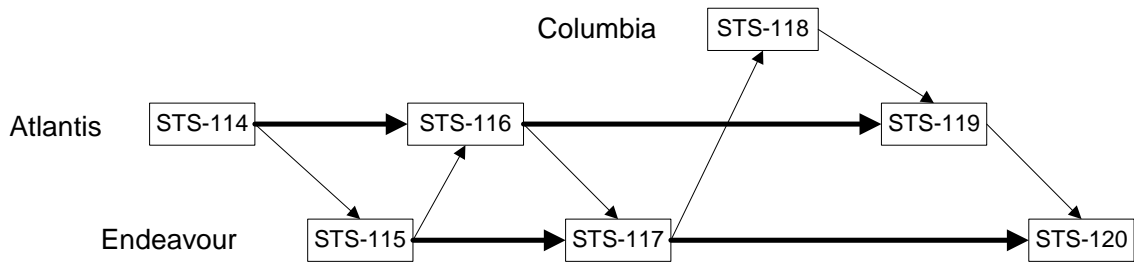

Figure 24: Space Shuttle Orbiter Space Station Assembly Sequence

Figure 25 shows excerpts from an actual planning document used by NASA during this time period.

BASELINE MANIFEST (FDRD) / PREL. PROG. PLAN

KSC ASSESSMENT / ORB MULTI-FLOW

◆ KSC ASSESSMENT (SLIP or OPTION)

SSP APPROVED MANIFEST OF 9-12 & 10-8-02 & INTERIM
ISS ASSY SEQ. REV. F (SSCN 7083 R2) DATED 10/15/02

* INDICATES CHANGE SINCE LAST PUBLICATION

1245 19 DEC 2002

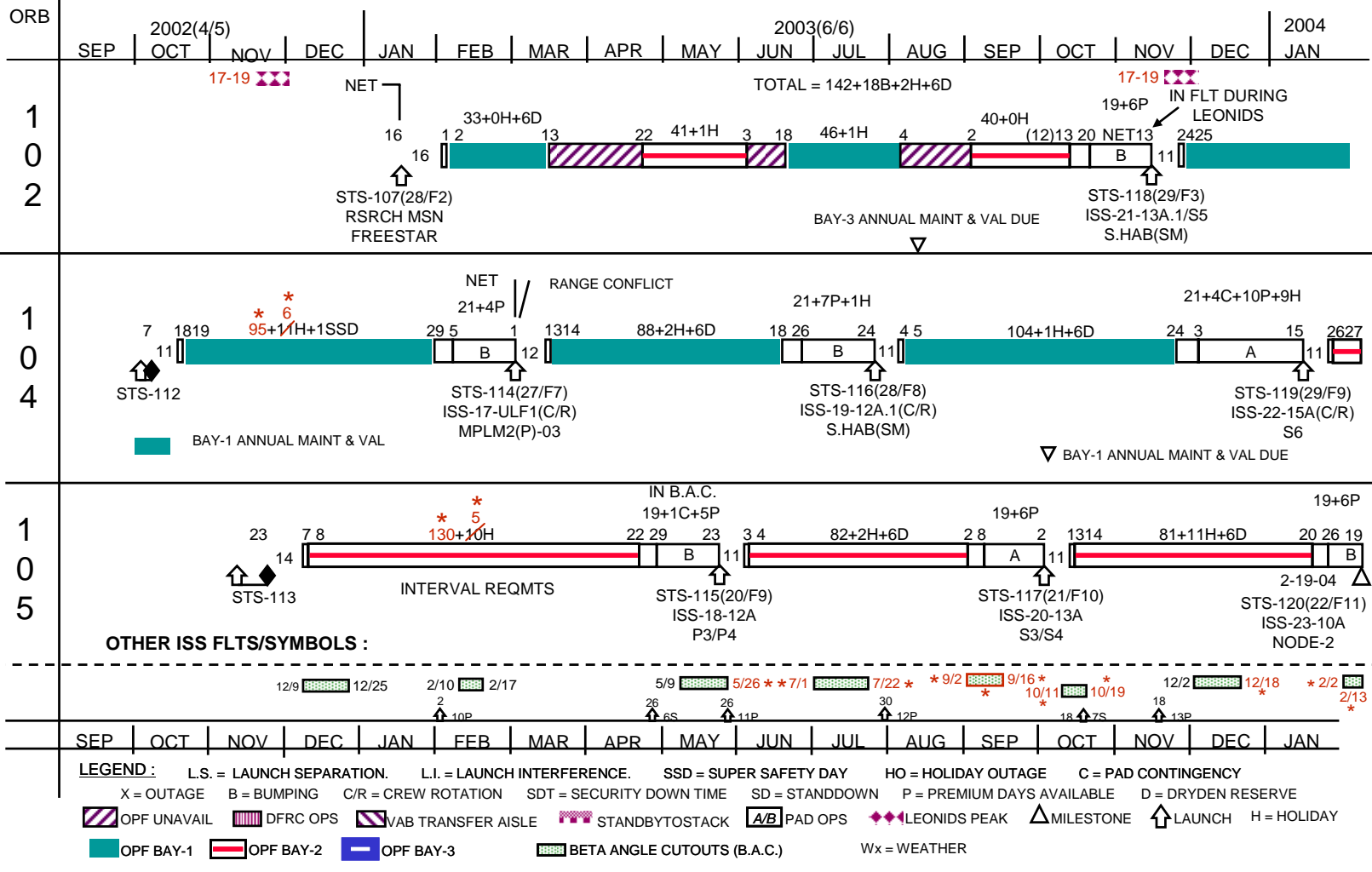

Figure 25: Orbiter Resource Utilization Chart

A brief review of the details of the Space Shuttle processing flow and where schedule margin resides is presented in the next section.

Space Shuttle Processing Flow

Figure 26 shows a diagram of the processing and mission cycle for a typical Space Shuttle mission. The diagram shows the flow of a Space Shuttle orbiter going through mission preparation, launch, mission operations, landing, and then returning to the mission preparation phase.

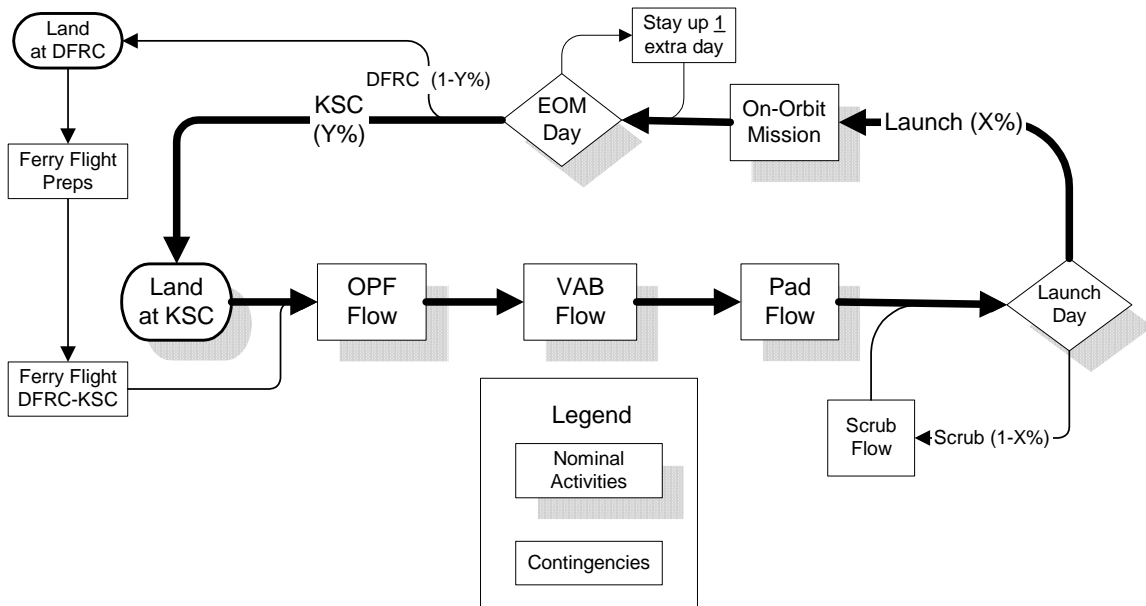
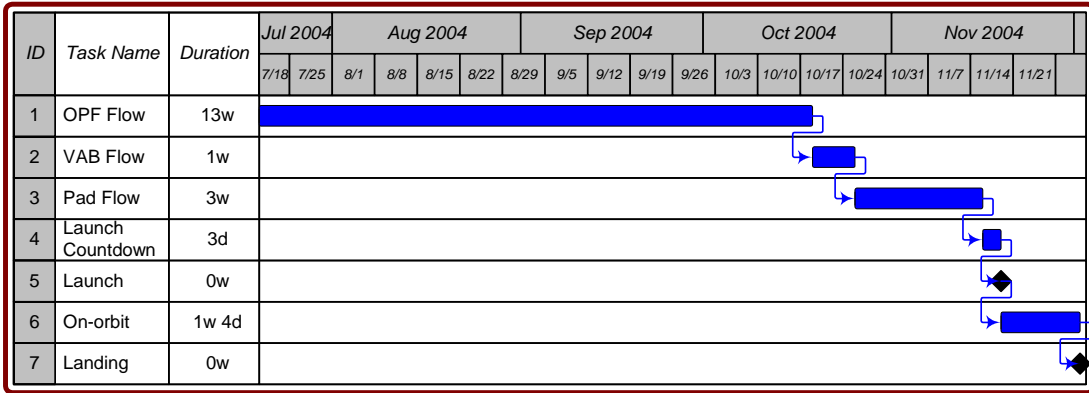

Figure 26: Space Shuttle Mission Cycle

The shuttle mission cycle can be displayed using tools more familiar to project

management such as Gantt charts or PERT/CPM precedence diagram. Figure 27 shows a Gantt chart of the Space Shuttle mission cycle.



Shuttle Gantt Chart.vsd

Figure 27: Shuttle Gantt Chart

The first step of mission preparation is accomplished in the Orbiter Processing Facility (OPF) and is called the OPF Flow. In the OPF the orbiter is deconfigured from the previous mission, undergoes detailed inspections and testing, and finally is configured for the upcoming mission. The process takes approximately 90 calendar days. There is, however, great variability in that number. Planned work is scheduled Monday through Friday, typically on a 2 shift per day basis. It is rare that any of these days are available as margin days. About three quarters of the Saturdays have planned work with the remainder available as margin. About one quarter of the Sundays have scheduled work and the remainders are available as margin. Given a 13 week processing flow, then 2 Saturdays and 5 Sundays might typically be available as margin. These numbers will vary

based upon the specifics of the processing flow for each mission. The Saturday and Sunday margin days are used as required to accommodate work content growth that occurs during the processing flow. Holiday margin may also be available if the OPF flow extends over a time period containing a holiday such as Thanksgiving, Fourth of July, Christmas to New Years, etc. Holidays are typically protected as much as possible and used only as a last resort.

A category of margin unique to the OPF flow is called Dryden Reserve and it stems from the potential that the orbiter may land in California. There is approximately a 20 percent chance that an orbiter will be diverted to the Dryden Flight Research Center in California. When this happens it takes several days to prepare and ferry the orbiter back to Florida. The start of the OPF processing flow is delayed by that amount. Consequently, NASA holds 6 days of Dryden Reserve in each OPF processing flow as schedule insurance should the orbiter be so diverted.

Once the orbiter has been processed through the OPF, the orbiter then goes to the Vehicle Assembly Building (VAB) where it is integrated with the Solid Rocket Boosters and External Tank. This activity typically occurs over 7 calendar days. Five of these days have planned work and two are available as margin. As with the OPF flow, if the VAB activity occurs over a holiday, then that day will not be worked. It may be used as margin.

Finally the orbiter, which is now a part of what is called an Integrated Space Shuttle Vehicle, goes to the launch pad where it is prepared for launch. Launch preparations at the launch pad typically take about three weeks with six weekend days

usually available as margin. There may also be a couple in-week contingency days depending upon the specific mission. Like the OPF and VAB activities, if the Pad flow extends over a holiday period, then those days will be protected and potentially available as margin.

In summary, the OPF, VAB, and Pad pre-launch activities are the only places where schedule margin resides. However, there are other important activities in the operations cycle of the orbiter and they are described below. These activities are important to understand because, while they have little schedule margin—on the order of a few hours—they are significant contributors to schedule risk.

After the launch countdown preparations have been completed, the three-day launch countdown is conducted. There is approximately a 55 percent chance of launching. Approximately 45 percent of the time launch does not occur. The duration of the time required to get back to a subsequent launch attempt is highly dependent upon the reason for the delay. For weather related delays, it typically takes one day. More difficult technical problems may take several weeks to correct before launch can be attempted again. Because delays experienced during launch countdown occur after all the margin for that mission has been used, the main effect of these delays is to delay the start of the subsequent OPF processing flow.

Once launch does occur the orbiter enters earth orbit to perform its assigned mission. Mission duration is typically planned for 10 to 11 days. However, the duration of the mission can grow. For example, it happens on occasion that the mission is extended by one day so as to achieve all of the mission objectives. More often it is the

case that missions are extended in order to wait for the landing weather to improve in Florida. Due to commodity limitations, the total on-orbit time cannot extend beyond approximately 4 extra days. The effect of mission duration growth is to delay the start of the next OPF flow.

This Space Shuttle flow model is focused on the most critical resource: that being the Space Shuttle orbiter. While there are other important resources such as the Solid Rocket Boosters and External tank, the experience has been that the orbiter tends to be the critical path resource. The standalone processing flows for the Solid Rocket Boosters and External Tank are planned such that they have sufficient schedule margin to preclude, with reasonable confidence, their becoming the critical path. Consequently, the margin assessment effort was focused upon margin available in the processing cycle of the Space Shuttle orbiter.

Margin Assessment Results

The information assembled for the margin assessment is shown in Table 3. The table shows the orbiters, their respective Space Station assembly missions, planned launch dates, and schedule margin, which is divided into three categories.

Table 3: Margin Assessment

Orbiter	STS Mission	Launch Date	Processing Margin	Holiday Margin	Dryden Reserve	Totals
Atlantis	114	1-Mar-03	6	0	N/A	6
Endeavour	115	23-May-03	17	1	N/A	18
Atlantis	116	24-Jul-03	26	3	6	35
Endeavour	117	2-Oct-03	18	2	6	26
Columbia	118	13-Nov-03	42	2	6	50
Atlantis	119	15-Jan-04	14	12	6	32
Endeavour	120	19-Feb-04	17	11	6	34
			140	31	30	201

Processing margin typically consists of the Saturdays and Sundays of the OPF, VAB, and Pad flows that do not have scheduled work. In-week days without scheduled work would also fall into this category. Holiday margin and Dryden reserve margin were described in the preceding section.

The missions where Dryden reserve is shown as non-applicable were missions that were already in process such that the threat of a Dryden landing no longer applied.

There were 201 total days of margin as shown in Table 3. NASA officials questioned whether or not launch of STS-120 (Node-2) on February 19, 2004 was likely with this amount of margin. Since no one could provide a satisfactory answer, an additional analysis of the issue was requested. This analysis led to the development of the Project Assessment by Simulation Technique.

A prototype of the Project Assessment by Simulation Technique was ultimately developed so as to answer the above question. However, before developing a simulation based technique, an initial analysis of the problem was conducted before concluding that

discrete event simulation was well suited for this particular problem.

Initial Analysis of the Project Margin Problem

The analysis of the project margin problem began with a review of historical data to determine past performance in achieving the orbiter related milestones critical to the manifest. Because the main question was with respect to how much margin was required, it was clearly important to understand how often margin days were used in the past. This historical data was used to build chronological run charts of added work days after project activity durations are established at the Delta Launch Site Flow Review. This review is analogous to a formal project review in which project task durations are agreed to. The run chart were analyzed to identify trends and outliers before determining what subset of the total historical data should be used as being predictive of future performance. Histograms and cumulative frequency distributions for added work days were then built for each of the project activities i.e. OPF, VAB, and Pad flows.

An analysis of the OPF historical data illustrates the process. Figure 28 shows the run chart that was produced for the OPF and presented to NASA. Causes for added work days include new work—modifications and special tests called “chits”—along with Problem Reporting and Corrective Action (PRACA). PRACA is the NASA terminology for the discovery of minor to major problems on the orbiter and their subsequent repair.

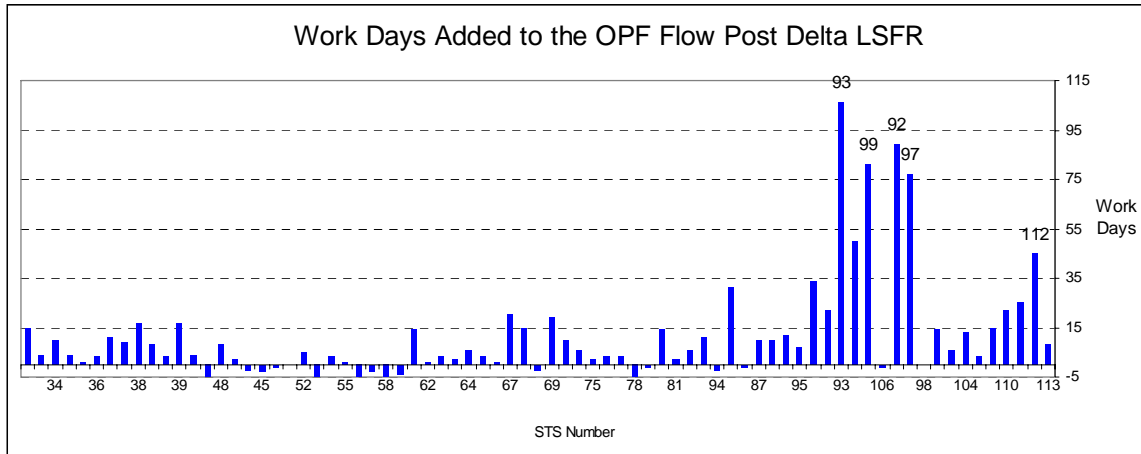

Sources of added work days include new program requirements (chits and modifications) and problems encountered during processing i.e. PRACA.

STS-93 (AXAF Payload Delays created opportunity to add work)
 STS-99 (Wiring Inspections)
 STS-92 (Launch Date Rebaselining created opportunity to add work)
 STS-97 (Same as 92)
 STS-112 (MPS Flow Liner)

Figure 28: Work Days Added to the OPF Flow Post Delta LSFR

Note the flows—STS-93, 99, 92, 97, and 112—that experienced large amounts of added workdays. The reasons for the work growth for these flows were researched. For example, the STS-93 mission had an unusually large amount of added work because the Advanced X-Ray Astrophysics Facility (AXAF) was delayed. The large amount of added work for the STS-112 mission was due to the difficulty in solving a technical problem involving small cracks in the flow liner of the Main Propulsion System (MPS). It was subsequently decided to exclude those data points under the assumption that they would not be predictive of the next seven Space Shuttle missions.

Figure 29 shows the corresponding histogram and cumulative frequency distribution for the data chosen from Figure 28 as being predictive of the future.

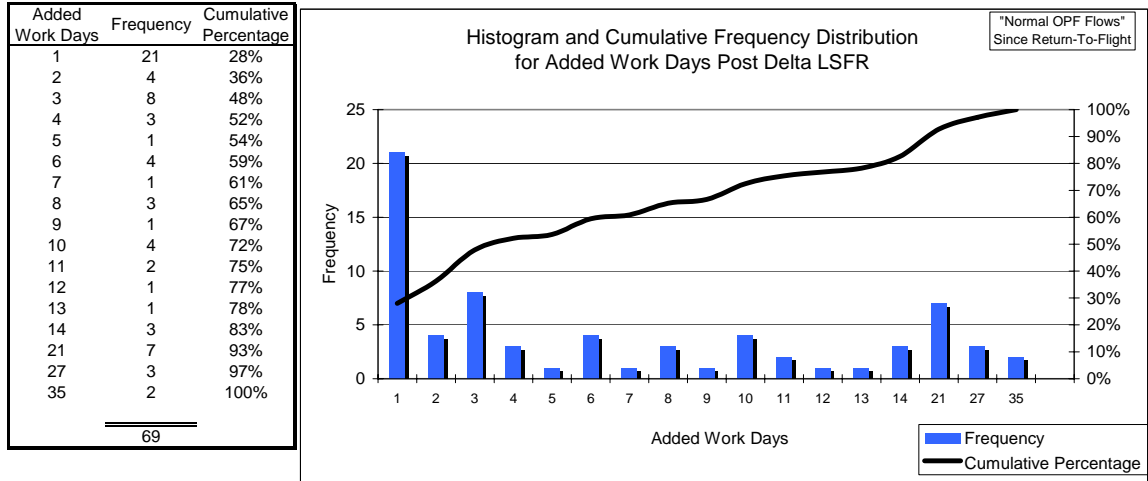

Figure 29: Histogram and CFD for OPF Added Work Days

The information in Figure 29 indicates that having the ability to absorb 4 added work days will preserve the ability to rollout of the OPF on time with a .5 probability. To increase that probability to .9 would require the ability to absorb approximately 18 added work days.

This same process was followed to analyze the VAB and Pad flows. Additionally, the historical data for added days occurring during Launch Countdown and the On-Orbit mission, as well as the added days as a result of DFRC landing was also reviewed. From this historical based review, and given certain assumptions, one can make conclusions regarding how much margin will be required for future Space Shuttle mission processing flows. The first assumption, or restriction, is that this analysis applies to only one Space Shuttle mission and assumes that the project start date—designated as

OPF roll-in—occurs on time. Additionally, the amount of margin required is a function of the level of confidence you want to have in achieving an on-time start to the next project. Table 4 shows the combined results.

Table 4: Margin Days Required To Ensure Next Project Starts on Time

Number of Margin Days Required To Ensure Next Flow Is Not Impacted							
Desired Level Of Confidence	OPF	VAB	Launch Pad	Launch Countdown	On-Orbit Duration	DFRC Landing	Total
30%	1	0	1	0	0	0	2
40%	2	0	2	0	0	0	4
50%	4	0	3	0	0	0	7
60%	6	1	4	1	0	0	12
70%	10	2	6	2	0	0	20
80%	14	3	9	5	1	12	44
90%	18	4	14	14	1	13	64
99%	32	14	28	70	3	14	161

The information in Table 3 and Table 4 was combined with the sequencing of the seven Space Shuttle missions in an attempt to see what conclusions could be drawn regarding likelihood of completing the project on time. Figure 30 shows the seven Space Shuttle missions with the available margin.

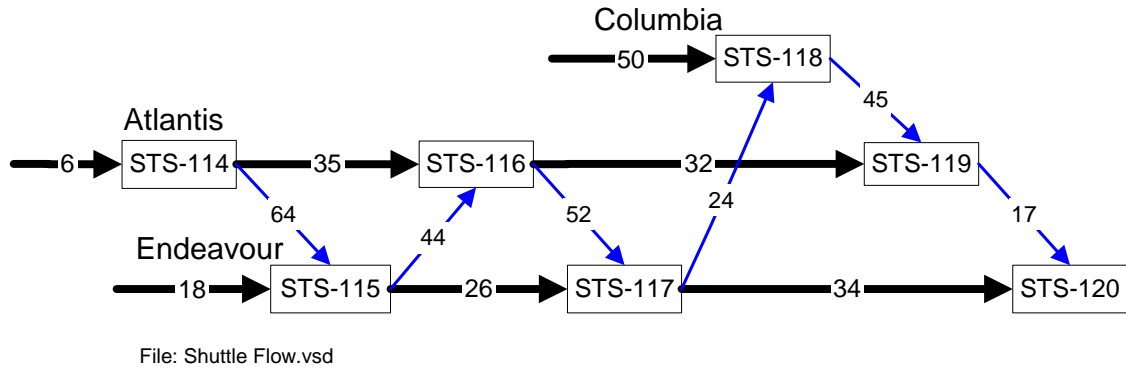

Figure 30: Available Margin Diagram for the Node-2 Milestone

In Figure 30 the thick horizontal bars represent the OPF, VAB, and Pad activities up to start of launch countdown. The numbers within these bars are the amount of available margin days. The thin diagonal bars represent the sequencing constraints of the Space Shuttle mission. The numbers within these diagonal bars are the number of days that the launch of the preceding mission can slip without impact the next launch. The rectangular boxes represent the time period of launch countdown, on-orbit mission, and landing. These periods contain no significant margin.

The above process did not yield a quantitative assessment of the range of likely launch dates for the STS-120 Node-2 mission. Consequently, it was decided to utilize a discrete event simulation based assessment.

Project Assessment by Simulation Technique Prototype

Once it had been decided to employ discrete event simulation, the effort focused upon developing a model that would make use of the already available historical data analysis. It was not at first recognized that this task would lead to a more generic methodology for project management. Formalization of the Project Assessment by Simulation Technique would come later. The primary goal for the model of the Node-2 launch date was to provide a quantitative assessment of the likelihood of project completion by the planned date, i.e. that STS-120 (Node-2) would launch on February 19, 2004 or subsequent dates. A second influential goal was that of providing NASA with a tool for assessing how proposed actions would support or hinder timely project completion.

Managerial Controls Component

The managerial controls component for the pilot case study was essentially established when the analysis was requested. It was assumed that any results would be shown exclusively to the requestors. Where the results would go from there would be determined by those requestors.

Simulation Model Component

A first step was to build a simulation model of Space Shuttle mission preparation and performance. This model was built such that it was consistent with the modeling constructs as described in Chapter 3.

The activity construct was used to model the three major Space Shuttle mission preparation operations—OPF, VAB, and Pad. The model takes in as inputs planned processing days along with available margin days for each of the three major mission preparation operations. During runs of the simulation, arrival of the orbiter entity at each of the three locations is checked versus the planned arrival date and the amount of margin is adjusted accordingly. The margin days were modeled as processing margin, which included Dryden Reserve, and holiday margin. For modeling purposes Dryden Reserve was added to processing margin since that reserve becomes available as margin should the orbiter land in Florida as planned. Holiday margin was modeled separately because it was initially assumed that holidays were not available to be worked unless directed by management. There is higher cost for working over holidays.

Launch of the shuttle was modeled using a combination of the cyclical and alternative path event probability constructs. The event probability element includes the probability of launching or being delayed and the delay type. The delay type determines the alternative path and thereby length of time required to return to the next launch attempt.

Likewise, modeling of the landing at KSC versus landing at DFRC included both

the cyclical and alternate path event probability constructs. The cyclical component models the checking to see if weather is favorable for landing at KSC. If it is favorable, then landing at KSC occurs. If weather is unacceptable, then the shuttle can remain on orbit in the hope that the weather will improve. In addition to this cyclical component, there is also a probabilistic component in terms of the final outcome i.e. the orbiter can land some place other than KSC. This is driven by the fact that there is a limit to how many days the shuttle can wait on orbit. This time frame is on the order of 2 to 4 days. Thus, if the weather does not appear to be improving, Space Shuttle managers will decide to have the orbiter land in California.

The simulation model was tailored to specifically model the processing and sequencing of the seven missions. A predecessor mission on the orbiter Columbia that was not part of the seven missions was not included in the model. Additionally, the possibility of a serious anomaly such as a loss of vehicle event was discounted. Unfortunately, a loss of vehicle event did occur on the predecessor mission flown by Columbia. However, that accident occurred after the simulation model was built and after the analysis was presented to the project stakeholders. Consequently the loss of Columbia did not influence the prototype case study. It did, however, influence subsequent case studies, which will be discussed later.

Input Analysis Component

Historical Space Shuttle processing data was analyzed in order to populate the model with representative distributions for added processing days in each of the Space Shuttle missions. It was initially intended to use theoretical rather than empirical distributions. In fact the first simulation based analysis of the margin problem used theoretical distributions. This analysis was presented to NASA officials on December 12, 2002. These project stakeholders, unfamiliar with discrete event simulation, were equally unfamiliar with the Gamma and Weibull distributions selected to model added work durations for the OPF and Launch Pad respectively. Difficulty was also encountered when trying to explain how these distributions are used in the simulation model to determine added work. Greater success, in terms of gaining stakeholder understanding and acceptance, was achieved when empirical distributions were used. Consequently, subsequent to December 12, 2002 empirical distributions were predominantly used.

The analysis already performed with respect to creating histograms and cumulative frequency distributions for added work days in the various activities—OPF, VAB, Pad, etc.—was used to create the required empirical distributions. For example, the information in Figure 29—the histogram and cumulative frequency distribution for 69 past orbiter flows—yielded the empirical distribution shown in Figure 31.

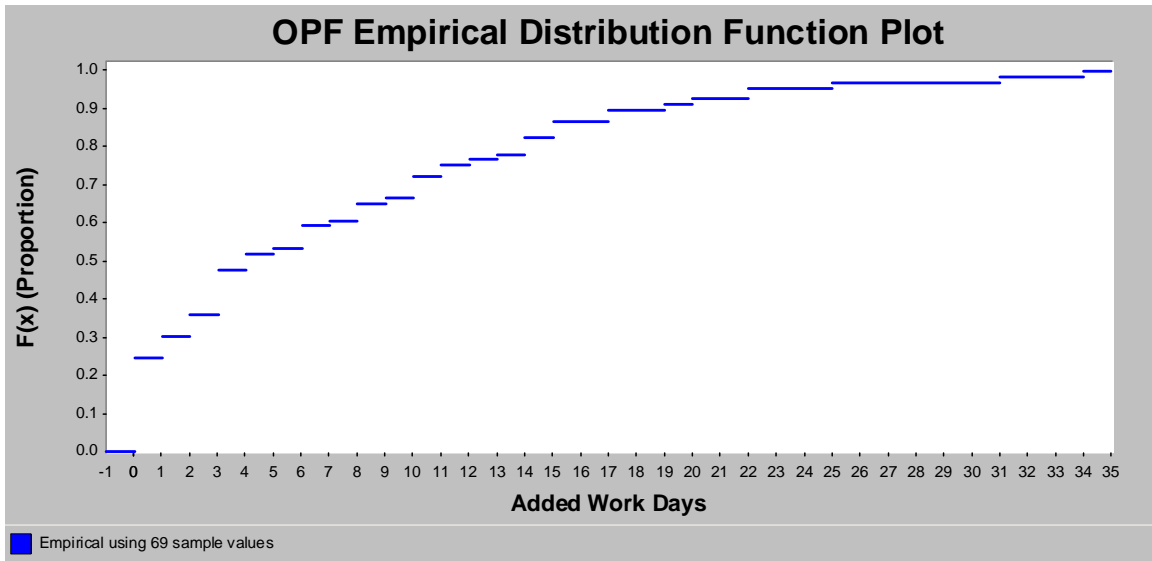

Figure 31: OPF Empirical Distribution for Added Work Days

The graphic in Figure 31 is produced by Averill M. Law’s ExpertFit software. This empirical distribution was transformed, again using ExpertFit, into a discrete distribution for the Discrete Event Simulation software. The discrete distribution is shown in Equation 5.

$$\text{DISC}(0.2464,0, 0.3043,1, 0.3623,2, 0.4783,3, 0.5217,4, 0.5362,5, 0.5942,6, 0.6087,7, 0.6522,8, 0.6667,9, \\ 0.7246,10, 0.7536,11, 0.7681,12, 0.7826,13, 0.8261,14, 0.8696,15, 0.8986,17, 0.9130,19, 0.9275,20, \\ 0.9565,22, 0.9710,25, 0.9855,31, 1.0000,34) \quad (\text{Equation 5})$$

A similar process was used to develop the distributions for added work days for the preparations that occur in the VAB and at the Launch Pad. Likewise, an empirical

distribution was determined for added on-orbit mission time. For example, a planned 11-day mission may grow to 12 days when the mission operation team determines that an added day is required to accomplish all the mission objectives.

Historical data was also used to determine the event probabilities for a launch versus a scrubbed or delayed launch. The probability of launch was determined to be .55 and the probability of a scrub or delay occurring was .45. After a scrub or delay, a period of time is required to recover from the delayed launch attempt so as to be in a position to launch again. The historical data was analyzed to determine the appropriate empirical distribution for that time duration. The data was also analyzed to see if the probability of launched changed after the occurrence of a delay. There did not appear to be a significant change, thus the launch probability was held constant.

Historical data was also used to determine the event probabilities for landing at KSC versus landing at DFRC at the end of the Space Shuttle mission. It was observed that the probability of achieving a KSC landing after waiving off the previous day changed. Consequently, this variation was included in the model.

Verification

The model was first run in a deterministic mode to ensure that it would properly reproduce launch of STS-120 on the planned date. After this step was successfully achieved the model was populated with the stochastic elements.

Output Analysis

The model was initially run in the stochastic mode for 300 replications. The choice of 300 replications was based upon the thinking that this would be a sufficiently large number of replication to achieve reasonable results. Figure 32 shows a histogram of the 300 replications along with the cumulative percentage. The cumulative percentage line represents the completion time distribution function for the launch date of STS-120.

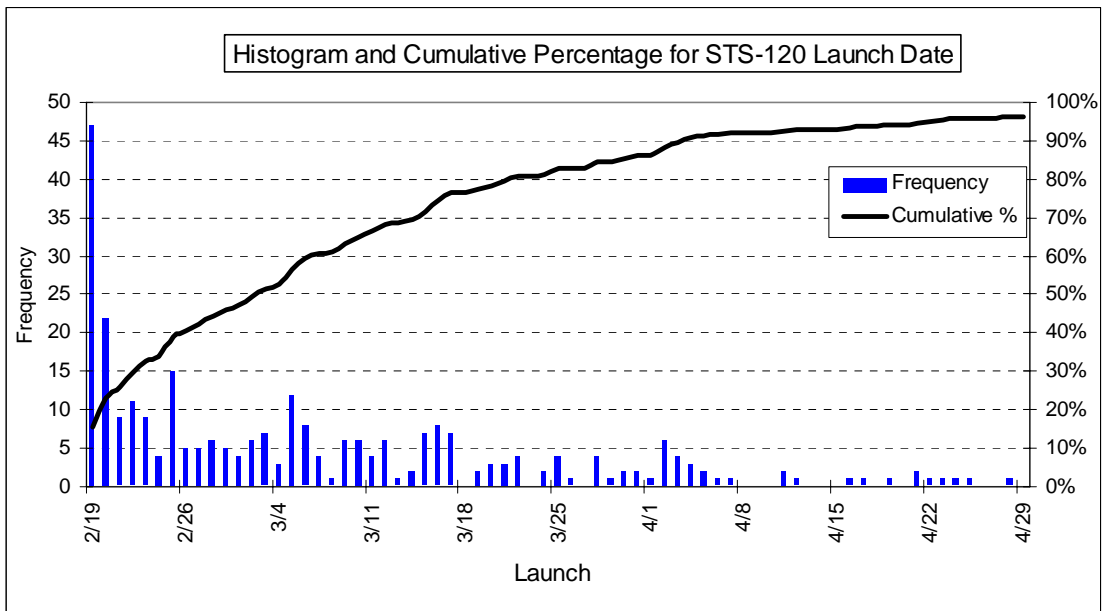

Figure 32: Completion Time Distribution Function for STS-120 Launch Date

Launch of STS-120 occurred on the planned date—February 19, 2004—approximately 16 percent of the runs (47 of 300 runs). Note that this 16 percent figure was a middle value of a normally distributed range of possible values. Further simulation

runs would be required to specify the confidence interval. Launch occurred within one week of the planned launch date 117 of 300 runs or approximately 39 percent. The 50th percent probability of launch occurred between March 2nd and March 3rd. The 80th percentile occurred between March 21st and 22nd and the 90th percentile occurred on April 3rd. The 99 percentile is approximately June 7th.

Figure 32 was embedded in a PowerPoint presentation that was first presented to NASA on January 6, 2003. A second presentation to a wider audience of higher level NASA officials occurred the next day. The then present political imperative to achieve the February 19, 2004 launch date was well known. Consequently, it was also known that a quantitative analysis indicating that this date was unlikely to be achieved might be unwelcome. Consequently, during the briefing on January 7th, emphasis was placed on explaining that the analysis included launch dates beyond February 19th and showed nearly a 90 percent chance of launch occurring by the first of April. This assessment was actually consistent with the official Space Shuttle Program position on the issue of the STS-120 launch date. That position was that February 19th was the planned launch date, but that there was up to a 45-day (plus or minus 15 days) threat to that date.¹⁹ This consistency lent validity to the results obtained via the Project Assessment by Simulation Technique. This indicated, therefore, that the first goal of PAST for this case study—providing a quantitative measure—had been successfully achieved.

During the briefing, NASA officials requested that the analysis be repeated with the assumption that holidays be treated as margin. This request suggested, at least in this case, that project stakeholders when made aware of a high likelihood of project tardiness

would take action to improve project completion timeliness. The request also provided an opportunity to fulfill the second goal of the methodology, which was to show the influence of managerial decisions on project completion timeliness.

The simulation was repeated as requested. This time, however, 3,000 replications of the two scenarios—one with Holidays as margin and one without Holidays as margin—were run so as to enable the determination of a confidence band along the entire Project Completion Distribution Functions. The requested analysis was completed and distributed for review on January 27, 2003. Figure 33 shows the results. The blue (darker) lines represent the simulation results for using Holidays as margin. The red (lighter) lines represent the baseline. The 95% confidence range is represented by the narrower lines.

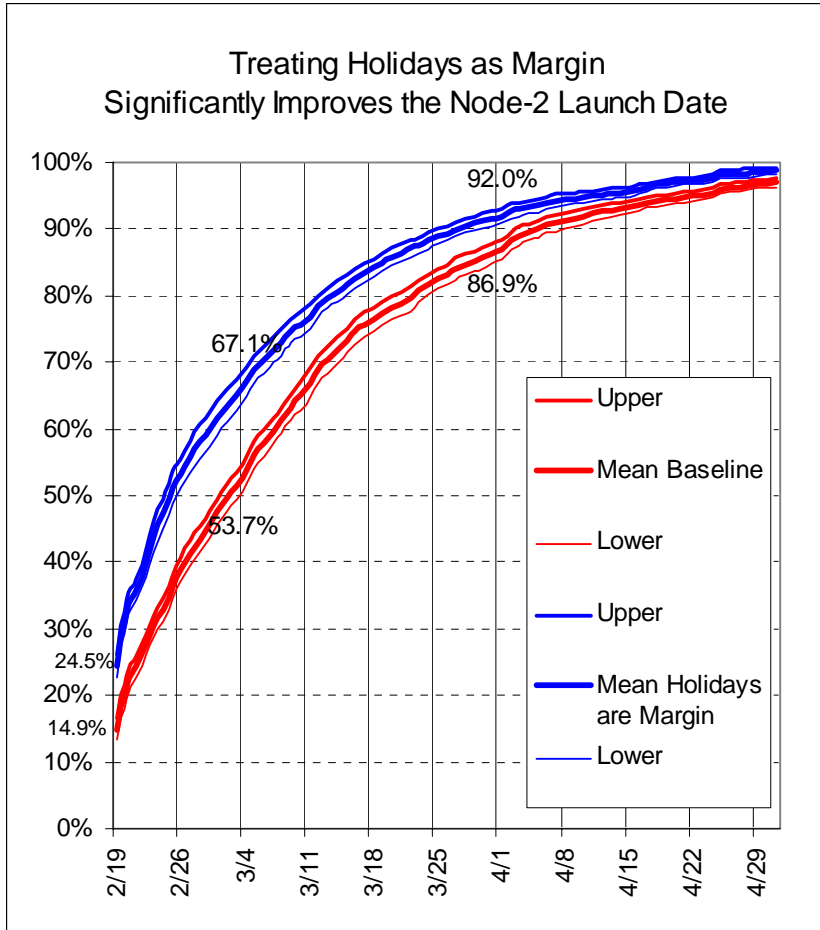

Figure 33: Working Holidays Improves STS-120 Launch Date

Working through holidays when required improves the STS-120 launch date. The lower limit 95-percent confidence for the ‘holidays-are-margin’ case does not overlap the upper limit for the Baseline case. This indicates that the improvement is significant.

Figure 34 shows more clearly the improvement to the launch date that is achieved by working holidays.

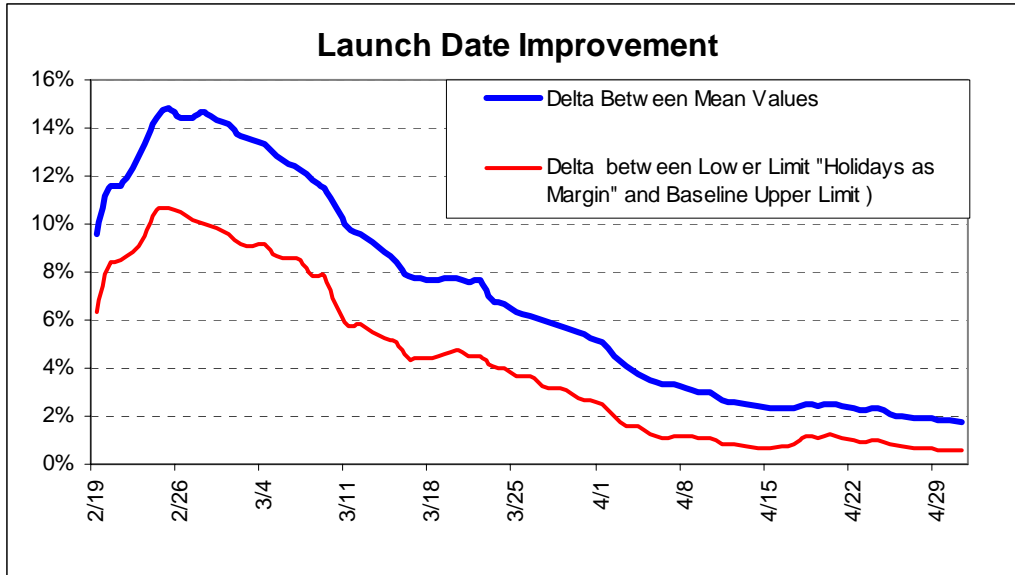

Figure 34: STS-120 Launch Date Improvement from Working Holidays

Figure 33 and Figure 34 provided a quantitative measure of the influence of a managerial decision on project completion timeliness. The thick blue (darker) line in Figure 34 represents the level of improvement based on the delta between the mean values. The thin red (lighter) line is the delta between the lower limit of working holidays and the upper limit of the baseline case. In other words, one would expect to see at least that level of improvement. Chance of achieving the 2/19/04 launch date is improved by at least approximately 6 percentage points and perhaps as much as 10 percentage points. The chance of launching within the first weeks is improved at least approximately 11 percentage points and so on. If a decision maker values an earliest possible launch date, then spending money to work holidays would make sense. Note, however, that the degree of improvement lessens for later launch dates. If a decision

maker is willing to accept launch dates beyond April, then working holidays might be considered less attractive.

Section II: Three Additional Case Studies

The Pilot Case study was completed just prior to the Columbia accident. As a result of the February 1, 2003 accident the ability to conduct further case studies was put on hold. The February through July time frame was occupied with various tasks related to recovering the Columbia debris and understanding the causes of the accident. However, beginning in August, the imperative to further develop PAST increased and time became available to do so. From October 2003 through June of 2004 three case studies were conducted. To set these case studies in their proper context additional background information is provided first.

Background Information

In August of 2003, the Columbia Accident Investigation Board released its first report, Volume 1, on the accident. The CAIB in section 6.2 of its report noted that there was pressure to achieve the Node-2 launch date of February 19, 2004 and that this pressure may have contributed to the loss of Columbia. Consequently, the CAIB advocated improved project risk management. CAIB recommendation 6.2-1 focused attention on future shuttle flight schedules.

Adopt and maintain a Shuttle flight schedule that is consistent with available resources. Although schedule deadlines are an important management tool, those deadlines must be regularly evaluated to ensure that any additional risks incurred to meet the schedule is recognized, understood, and acceptable.²⁰

The NASA administrator stated that NASA accepted the findings of the CAIB and would comply with all of its recommendation. The NASA Inspector General, through a series of audits, also assisted the agency in complying with the recommendations.²¹

Additionally, the NASA administrator committed the agency to raising the bar by going above and beyond just complying with the specific recommendations. As a result, additional launch restrictions would come to be placed upon the shuttle and these would have to be factored into future PAST models. Case study 1 focused solely on the issue of one of these new launch restrictions.

In January 2004, President George W. Bush announced a new vision for space exploration. This vision called for the extension of human presence across the solar system, starting with a human return to the moon by 2020, in preparation for human exploration of Mars and other destinations. Funding for the vision, which requires new vehicles to enable lunar and Mars missions, is thought to come in large part from the funding wedge currently occupied by the Space Shuttle and International Space Station programs. This funding wedge is on the order of \$6 billion per year, which equates to a

spending rate of approximately \$500 million per month.²²

The Vision for Space Exploration provides specific directives for the Space Shuttle. The first of these is to return the Space Shuttle to flight as soon as safely practical. After return-to-flight, NASA is directed to focus use of the Space Shuttle to complete assembly of the International Space Station. The shuttle is to be retired as soon as assembly of the International Space Station is completed—planned for the end of this decade. At that point, major funding will be available for lunar and Mars missions. Consequently, there is great interest in understanding when the ISS assembly will be finished and the Space Shuttle retired.

Enabling the vision for space exploration became a central theme of case studies 2 and 3. Case study 2 first explored the influence of augmenting the work force when a project appears to be likely to finish late. Case study 2 then analyzed the effects of project content reduction. Case study 3 shows the benefit, to project completion timeliness, in having a large project buffer.

Case Study 1: Launch Window Analysis

At the end of September 2003, NASA published the implementation plan for shuttle return to flight and beyond. This plan identified a new requirement to launch the shuttle in daylight. A PAST based analysis was requested in order to understand the potential impact of this new requirement.

Time periods when Space Shuttles can be launched to rendezvous with the International Space Station are constrained by a number of factors. There are only a few minutes out of each day in which the Space Station orbital ground track is sufficiently close to the Kennedy Space Center to allow a launch. Approximately 70 days out of the year the solar angle of incidence to the Space Station is such that, for a variety of reasons, the Space Shuttle orbiter cannot be docked to the Space Station. Consequently the Space Shuttle cannot be launched during these periods. The daylight only requirement would mean that approximately 170 days out of each year are unavailable for launches. The combination of all these restrictions would mean that windows of opportunity to launch the Space Shuttle in the future could be greatly limited. For example, it was postulated that in some situations there might only be a three-day launch window, with each of the three days having less than 10 minutes of opportunity. If the shuttle did not launch on one of those three days, then the next launch attempt might have to wait several weeks.

Given such a potentially onerous restriction, there was interest in the overall impact to launch probability and the potential benefit of taking mitigating actions. For example, changing the altitude of the Space Station could increase the launch window from 3 days to 5 days. Officials wanted to know if that change would improve overall launch probability, and if so, by how much.

PAST was used to determine the launch probability for 3-day versus 5-day windows of opportunity. The analysis was done under a variety of assumptions. Figure 35 shows the analysis under the assumption that the orbiter arrives at the launch pad on time and the processing flow has six days of margin.

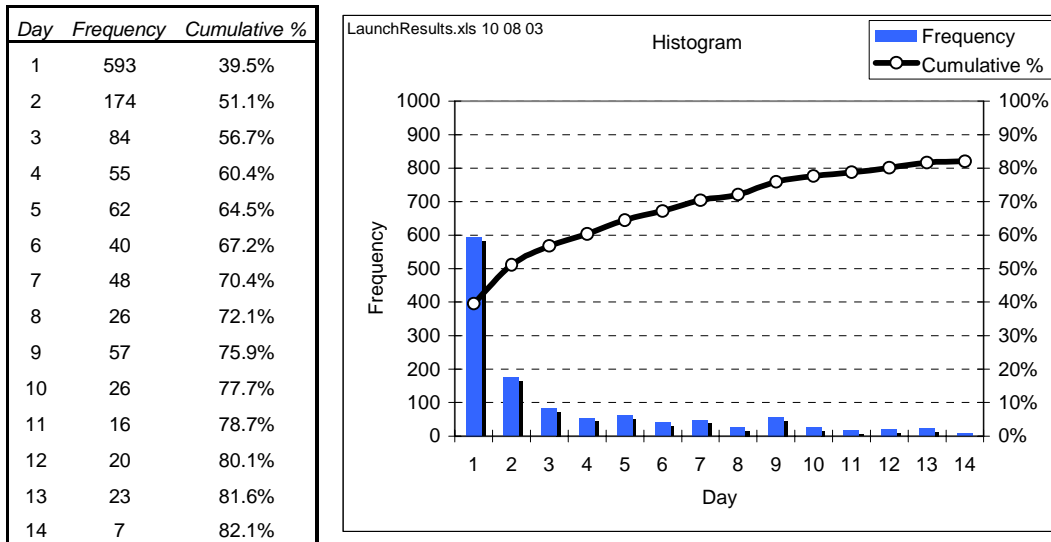

Figure 35: Launch Window Analysis

The analysis along with the supporting historical data and description of the methodology used for the analysis was presented to NASA on October 10, 2003. As a result of that presentation, additional analysis was requested. The historical data suggested that launches were more likely to be delayed during winter months. Consequently, an analysis was requested in which a modifier would be used to decrease the probability of launch during the winter. NASA also requested that the simulation model be extended to include schedule risk for shuttle assembly operations in the Vehicle Assembly Building. Figure 36 shows the new results based upon the use of the winter weather launch probability modifier.

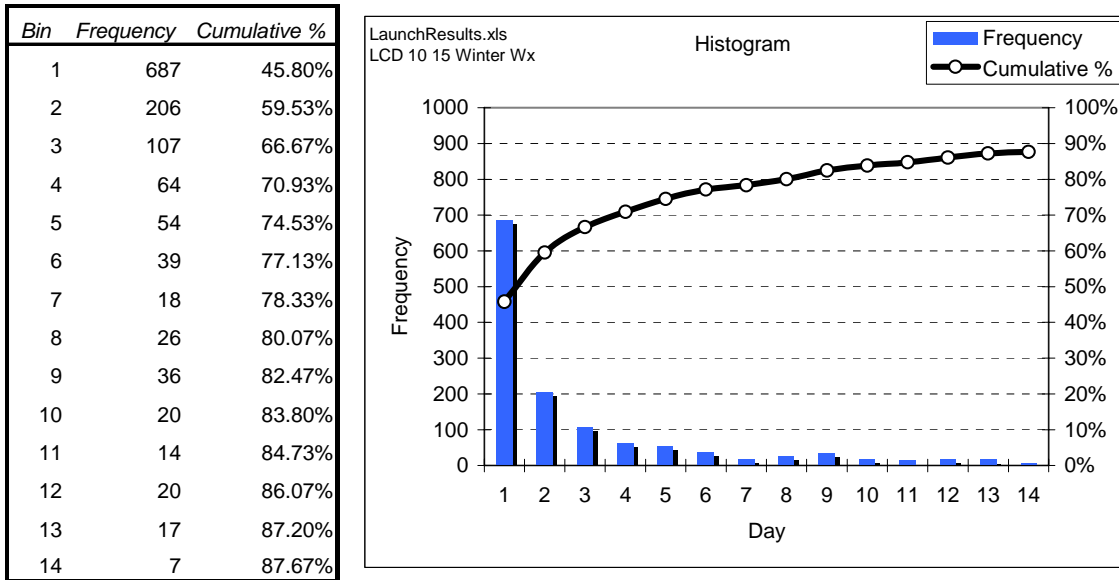

Figure 36: Launch Probability with Winter Weather Modifier

Probability of launching during a three-day window of opportunity is approximately 67% and approximately 75% for a five-day window: a gain of 8 percent. Recall that without the winter weather modifier the results were 72% and 78% for the three and five-day windows respectively.

The complete set of requested analysis was graphed together to facilitate visualization of the results. The simulation results graphed included the VAB activity, launch pad activity, launch countdown, and winter weather modifier for launch probabilities, and with various quantities of launch pad margin days. Figure 37 shows that graphic.

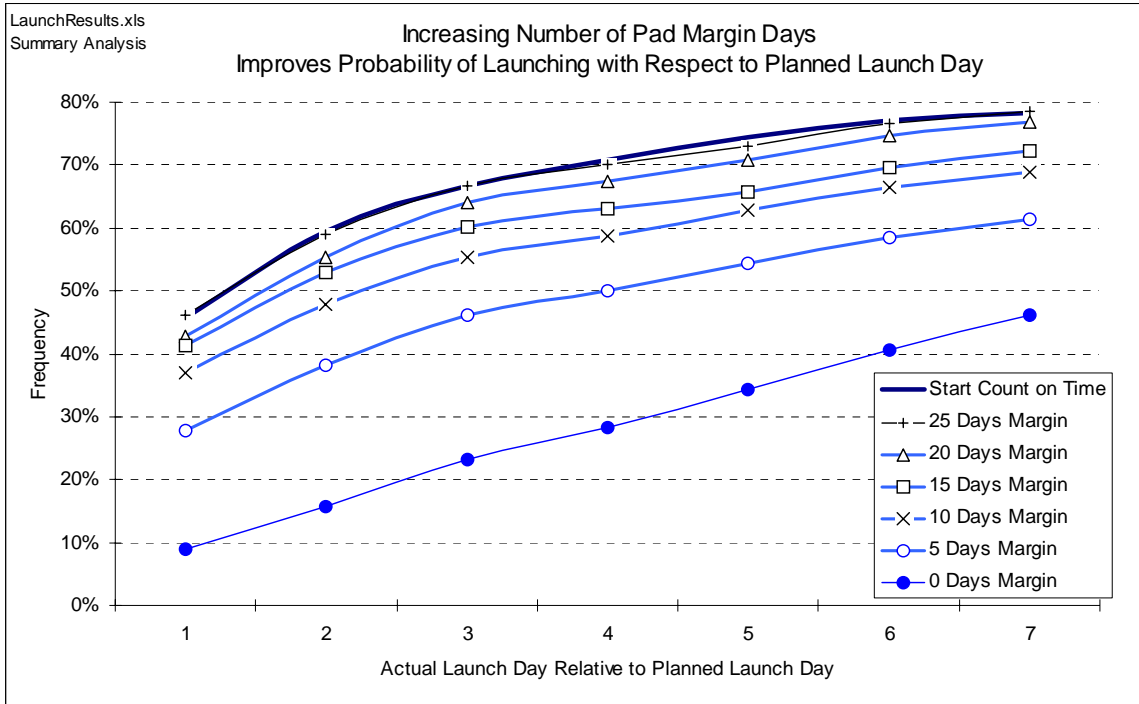

Figure 37: Launch Probability Comparisons

The increased probability of launch, brought about by having 5 days of opportunity, was not considered great enough to risk lowering the altitude of the Space Station. Consequently, that option is no longer being considered.

Case Study 2: Manifest Option 04A-29

In March of 2004, NASA created manifest option 04A-29, which was subsequently used in support of developing the budget for the Space Shuttle program.

Table 5 shows the relevant details of that option.

Table 5: 04A-29 Manifest Option

OV-103 Missions	Pred.	OPF Start Date	P	H	M	VAB Start Date	P	H	M	Pad Start Date	P	H	M	CD	Launch Date	MD
114	None	1-Jan-04	365	11	6	17-Jan-05	5	2	0	24-Jan-05	26	12	0	3	6-Mar-05	12
116	115	19-Mar-05	209	4	6	24-Oct-05	5	2	0	31-Oct-05	19	7	2	3	1-Dec-05	12
119	118	14-Dec-05	155	13	6	6-Jun-06	5	2	0	13-Jun-06	20	6	1	3	13-Jul-06	11
123	122	25-Jul-06	117	3	6	28-Nov-06	5	2	0	5-Dec-06	25	12	11	3	25-Jan-07	10
126	125	5-Feb-07	111	2	6	4-Jun-07	5	2	0	11-Jun-07	21	6	1	3	12-Jul-07	10
128	127	23-Jul-07	91	1	6	29-Oct-07	5	2	0	5-Nov-07	21	6	1	3	6-Dec-07	10
130	129	17-Dec-07	90	10	6	1-Apr-08	5	2	0	8-Apr-08	20	6	1	3	8-May-08	10
132	131	19-May-08	92	2	6	27-Aug-08	5	2	1	4-Sep-08	19	6	0	3	2-Oct-08	10
141	140	13-Oct-08	638	29	6	17-Aug-10	5	2	0	24-Aug-10	20	6	1	3	23-Sep-10	10
143	142	4-Oct-10	96	11	6	25-Jan-11	5	2	0	1-Feb-11	21	6	0	3	3-Mar-11	10
OV-104 Missions																
121	114	1-Jan-04	425	16	6	23-Mar-05	5	2	0	30-Mar-05	24	8	1	3	5-May-05	11
115	121	17-May-05	90	2	6	23-Aug-05	5	2	0	30-Aug-05	20	6	1	3	29-Sep-05	11
118	117	11-Oct-05	149	13	6	28-Mar-06	5	2	0	4-Apr-06	20	6	1	3	4-May-06	11
122	120	16-May-06	97	2	6	29-Aug-06	5	2	1	6-Sep-06	20	6	0	3	5-Oct-06	10
125	124	16-Oct-06	145	11	6	27-Mar-07	5	2	0	3-Apr-07	20	7	1	3	4-May-07	11
134	133	16-May-07	649	29	6	30-Mar-09	5	2	0	6-Apr-09	21	6	1	3	7-May-09	10
136	135	18-May-09	92	0	6	24-Aug-09	5	2	0	31-Aug-09	17	4	0	3	24-Sep-09	10
138	137	5-Oct-09	96	11	6	26-Jan-10	5	2	0	2-Feb-10	21	6	0	3	4-Mar-10	10
140	139	15-Mar-10	91	2	6	22-Jun-10	5	2	0	29-Jun-10	20	6	1	3	29-Jul-10	10
142	141	9-Aug-10	119	2	6	14-Dec-10	5	2	0	21-Dec-10	18	6	10	3	27-Jan-11	10
OV-105 Missions																
117	116	1-Jan-04	712	34	8	24-Jan-06	5	2	0	31-Jan-06	20	7	0	3	2-Mar-06	11
120	119	14-Mar-06	110	3	6	11-Jul-06	5	2	0	18-Jul-06	21	6	0	3	17-Aug-06	10
124	123	28-Aug-06	130	12	6	23-Jan-07	5	2	0	30-Jan-07	21	6	0	3	1-Mar-07	10
127	126	12-Mar-07	160	3	6	28-Aug-07	5	2	1	5-Sep-07	20	6	0	3	4-Oct-07	10
129	128	15-Oct-07	96	11	6	5-Feb-08	5	2	0	12-Feb-08	21	6	0	3	13-Mar-08	10
131	130	24-Mar-08	105	2	6	15-Jul-08	5	2	0	22-Jul-08	22	12	0	3	28-Aug-08	10
133	132	8-Sep-08	90	2	6	15-Dec-08	5	2	0	22-Dec-08	19	6	10	3	29-Jan-09	10
135	134	9-Feb-09	98	2	6	26-May-09	5	2	0	2-Jun-09	21	6	0	3	2-Jul-09	10
137	136	13-Jul-09	99	1	6	27-Oct-09	5	2	0	3-Nov-09	21	6	0	3	3-Dec-09	10
139	138	14-Dec-09	97	10	6	6-Apr-10	5	2	0	13-Apr-10	16	4	0	3	6-May-10	10

Legend			
CD	Count Down Duration	MD	Mission Duration
H	Holidays	P	Process Days
M	Margin Days	Pred.	Predecessor Mission

The 04A-29 manifest assumed a return to flight in March of 2005, an annual flight rate of 5 flights per year, and a total of 30 missions to complete assembly of the Space Station with the last mission (STS-142) launched in March of 2011.

At NASA's request, a variety of PAST based analyses were conducted using the 04A-29 manifest option. These analyses were performed under a variety of additional assumptions and in response to suggestions provided from NASA that were meant to improve project completion timeliness. For example, during March of 2004, concerns were expressed within NASA that the manifest based budget at that time might be optimistic in terms of how long it was going to take to complete assembly of the ISS. NASA requested a PAST based analysis of the 04A-29 option to help quantify that concern. The initial analysis results are shown in Figure 38.

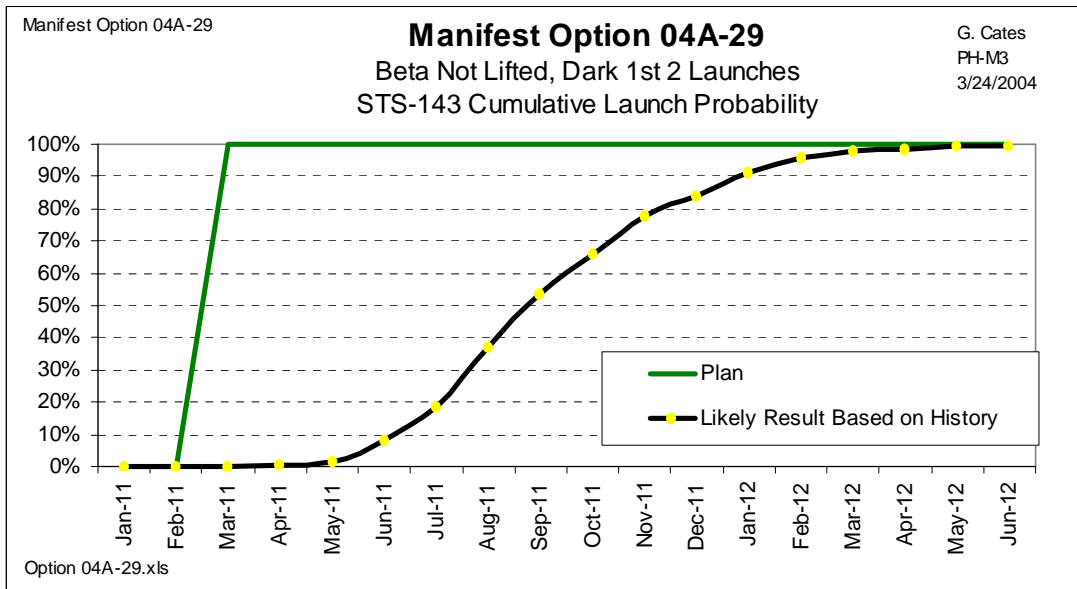

Figure 38: Initial Analysis of 04A-29 Manifest Option

The cumulative launch probability function indicates that the actual launch date for STS-143 (the 30th mission), planned for March of 2011, could be anywhere from May of 2011 through June of 2012.

NASA responded positively to the PAST analysis in two ways that should result in improved project completion performance. The first was to request an increase in the size of the work force. The second was to suggest reduced project content. Both of these suggested actions were analyzed by PAST at NASA's request.

Work Force Augmentation

The analysis shown in Figure 38 was used by NASA officials in support of budget negotiations to augment the United Space Alliance Ground Operations work force. United Space Alliance is the prime contractor to NASA for performing Space Shuttle processing. It was believed that a work force augmentation on the order of approximately 300 people would provide processing flexibility to meet the manifest. There were also recommendations from the Columbia Accident Investigation Board that indicated work force augmentation was desirable. A new simulation analysis was requested to analyze the influence of workforce augmentation.

Note first that the simulation results displayed in Figure 38 were subsequently determined to be optimistic due to assumptions in the model and also requirements that were not modeled. The risk of a delay to the first Post-Columbia launch was assumed to

be equal to that of any other launch. In reality, there is a greater likelihood that the first launch will experience a delay. Additionally, the potential magnitude of that delay is likely to be greater than for other launches. Similarly, the risk of schedule delays for OPF flows was assumed to be equal for all flows. In reality, longer duration flows in which extensive maintenance and modifications are performed are more likely to be delayed by greater durations. Not included in the model was the then emerging requirement to have a shuttle ready to “launch-on-need” to perform a rescue of a crippled orbiter.

Consequently, the first step in the new analysis was to address the aforementioned optimistic assumptions and missing launch-on-need requirement in the model. The assumptions were changed to reflect a more accurate view of schedule risk for longer duration OPF flows. The launch-on-need requirement was added into the model. These changes resulted in shift to the right of the completion distribution function for Space Station assembly completion.

The question then became how to model the augmented work force. Perhaps more precisely, the question was how would the additional workers be used? These questions, while not fully resolved, essentially boiled down to two alternatives. The first alternative assumed that the additional workers would provide a roving team that would focus on minimizing the effects of added work occurring in the OPF. In this way, the OPF rollout milestone would be more likely to occur on time. The second alternative assumed that the added workers could be used to reduce the planned activity duration. The second alternative was used for the new analysis. Figure 39 shows the potential benefit from augmenting the shuttle workforce under that assumption.

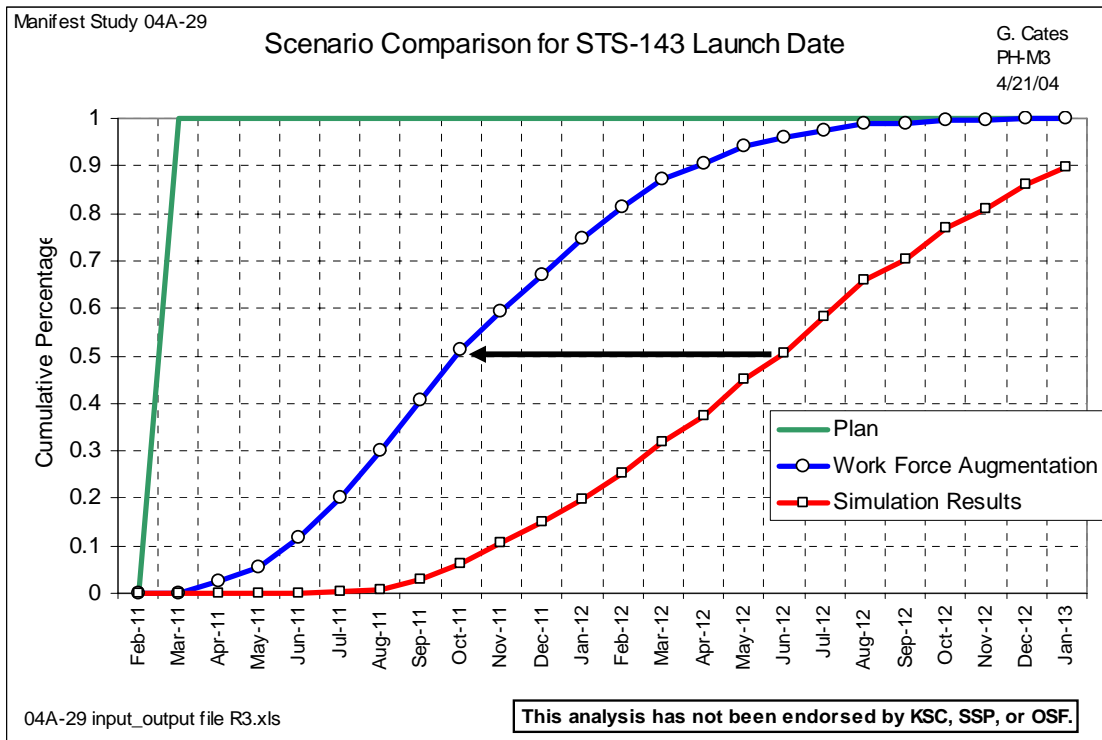

Figure 39: Potential Benefit from Workforce Augmentation.

The PAST based analysis showed a significant improvement to the ISS assembly complete milestone. At the 50th percentile, completion of the Space Station was improved by 8 months. This equates to a cost savings of approximately \$4 billion assuming that combined annual expenditures for the Space Shuttle program and Space Station assembly are approximately \$6 billion. Note again that the actual benefit from the workforce augmentation will be dependent upon how that work force is utilized. That issue requires further exploration. Nonetheless, the results were persuasive enough to bolster the case for workforce augmentation.

The NASA Implementation Plan for Space Shuttle Return to Flight and Beyond,

Vol.1, Revisions 2.1 dated July 28, 2004 shows that funding at the level of approximately \$32 million in FY04 and \$36 million in FY05 was subsequently approved for Kennedy Space Center Ground Operations work force augmentation. It is assumed that this level of funding, adjusted for inflation, will be authorized in future years. If that assumption holds, then the total cost to augment the work force should be on the order of \$400 million. This indicates that there is the potential for a tenfold return on investment.

Reducing Project Content

In April NASA requested an analysis based upon 28 shuttle missions being required to complete the Space Station. Previously it had been 30 missions, but missions 29 and 30 were scheduled beyond 2010. Given that NASA's goal was to complete the ISS and retire the shuttle by 2010, completing the Space Station with fewer missions was desirable.

The results of the analysis were as expected. A 28-mission assembly sequence would naturally finish before a 30-mission sequence. However, the simulation results still indicated that 28th mission was likely to launch after the desired completion deadline of "by 2010." Consequently, NASA also requested that work force augmentation be factored into the 28-mission sequence analysis. Figure 40 shows the Completion Time Distribution Functions for the Space Station given a 28-mission assembly sequence.

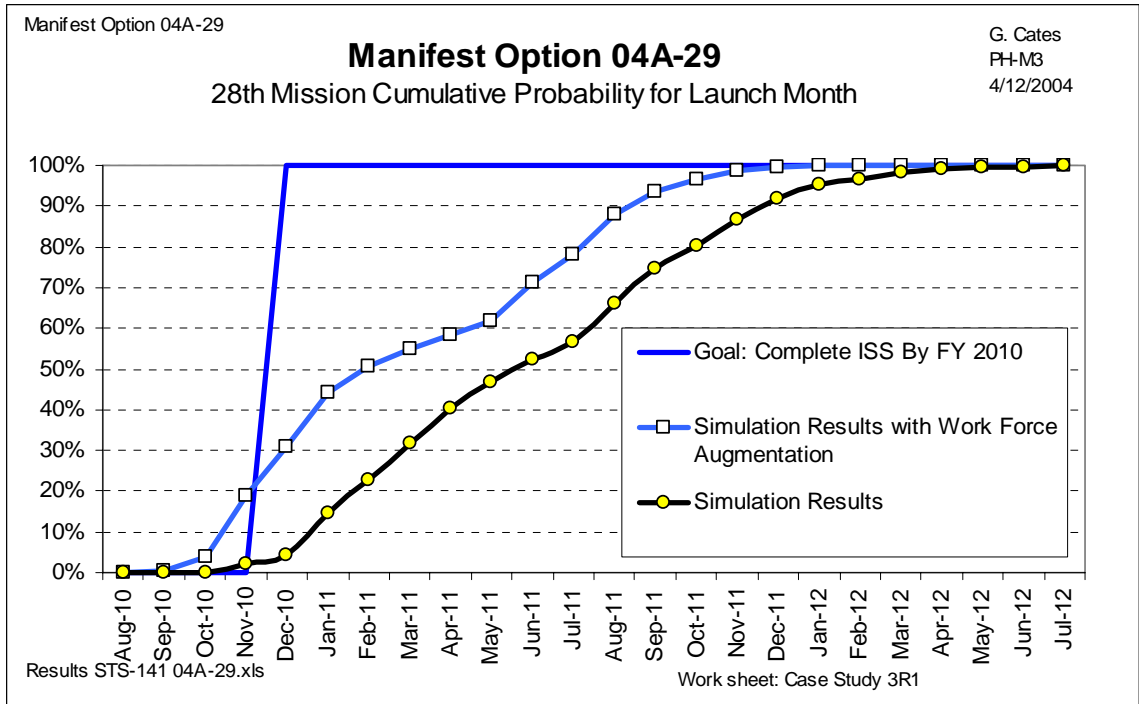

Figure 40: CTFD for STS-141 Launch Month

The ability to complete the assembly of the International Space Station by December 2010 is improved by reducing the planned number of missions from 30 to 28. Even greater improvement can be gained if work force augmentation is included.

Case Study 3: Project Buffer Benefit

The last analysis to be presented in this chapter highlights the benefits of having a large project buffer as suggested by the Critical Chain Project Management philosophy. On May 26th, NASA requested an analysis of manifest option 04A-49, which had only 23

missions. Table 6 shows the details of the 04A-49 option.

Table 6: 04A-49 Manifest Option

OV-103 Missions	Pred.	OPF Start Date	P	H	M	VAB Start Date	P	H	M	Pad Start Date	P	H	M	CD	Launch Date	MD
114	None	1-Jan-04	365	11	6	17-Jan-05	5	2	0	24-Jan-05	26	12	0	3	6-Mar-05	12
116	115	19-Mar-05	209	4	6	24-Oct-05	5	2	0	31-Oct-05	19	7	2	3	1-Dec-05	12
118	117	14-Dec-05	93	11	6	3-Apr-06	5	2	0	10-Apr-06	17	4	0	3	4-May-06	11
120	119	16-May-06	90	2	6	22-Aug-06	5	2	0	29-Aug-06	21	6	0	3	28-Sep-06	10
123	122	9-Oct-06	90	11	6	24-Jan-07	5	2	0	31-Jan-07	20	6	0	3	1-Mar-07	10
125	124	12-Mar-07	90	2	6	18-Jun-07	5	2	0	25-Jun-07	21	6	1	3	26-Jul-07	10
128	127	6-Aug-07	117	3	6	10-Dec-07	5	2	0	17-Dec-07	23	9	10	3	31-Jan-08	10
131	130	11-Feb-08	99	2	6	28-May-08	5	2	0	4-Jun-08	20	6	0	3	3-Jul-08	10
OV-104 Missions																
121	114	1-Jan-04	425	16	6	23-Mar-05	5	2	0	30-Mar-05	24	8	1	3	5-May-05	11
115	121	17-May-05	91	2	6	24-Aug-05	5	2	0	31-Aug-05	20	6	0	3	29-Sep-05	11
126	125	11-Oct-05	634	31	6	13-Aug-07	5	2	0	20-Aug-07	21	6	1	3	20-Sep-07	11
129	128	2-Oct-07	103	11	6	30-Jan-08	5	2	0	6-Feb-08	20	6	0	3	6-Mar-08	10
132	131	17-Mar-08	152	3	6	25-Aug-08	5	2	0	1-Sep-08	20	7	1	3	2-Oct-08	10
134	133	13-Oct-08	90	11	6	28-Jan-09	5	2	0	4-Feb-09	20	6	0	3	5-Mar-09	10
136	135	16-Mar-09	97	2	6	29-Jun-09	5	2	1	7-Jul-09	21	6	0	3	6-Aug-09	10
OV-105 Missions																
117	116	1-Jan-04	693	34	6	3-Jan-06	5	3	0	11-Jan-06	20	6	0	3	9-Feb-06	11
119	118	21-Feb-06	91	2	6	31-May-06	5	2	0	7-Jun-06	21	6	1	3	8-Jul-06	10
122	120	19-Jul-06	89	1	6	23-Oct-06	5	2	0	30-Oct-06	21	6	1	3	30-Nov-06	10
124	123	11-Dec-06	92	9	6	28-Mar-07	5	2	0	4-Apr-07	20	6	0	3	3-May-07	10
127	126	14-May-07	138	3	6	8-Oct-07	5	2	0	15-Oct-07	21	6	1	3	15-Nov-07	10
130	129	26-Nov-07	112	10	6	2-Apr-08	5	2	0	9-Apr-08	20	6	0	3	8-May-08	10
133	132	19-May-08	194	5	6	10-Dec-08	5	2	0	17-Dec-08	22	8	10	3	29-Jan-09	10
135	134	9-Feb-09	99	2	6	27-May-09	5	2	0	3-Jun-09	20	6	0	3	2-Jul-09	10

Legend			
CD	Count Down Duration	MD	Mission Duration
H	Holidays	P	Process Days
M	Margin Days	Pred.	Predecessor Mission

The last mission (STS-136, OV-104) was planned for launch on August 6, 2009,

which was greater than 1 year prior to the “by the end of the decade” desired completion date.

The simulation was run under a variety of assumptions. The simulation run that produced the best results included an assumption that normal OPF flows were limited to 90 days with the remainder of the time available as end of flow margin. Additionally, for the OMDP flow on OV-104, that 22-month duration was modeled as 16 months plus 6 months of margin. The results for this scenario, identified as S1.O, are shown in Figure 41. The chance of completing ISS by the end of FY2010 was approximately 73 percent. This was much better than any of the other manifest options previously analyzed.

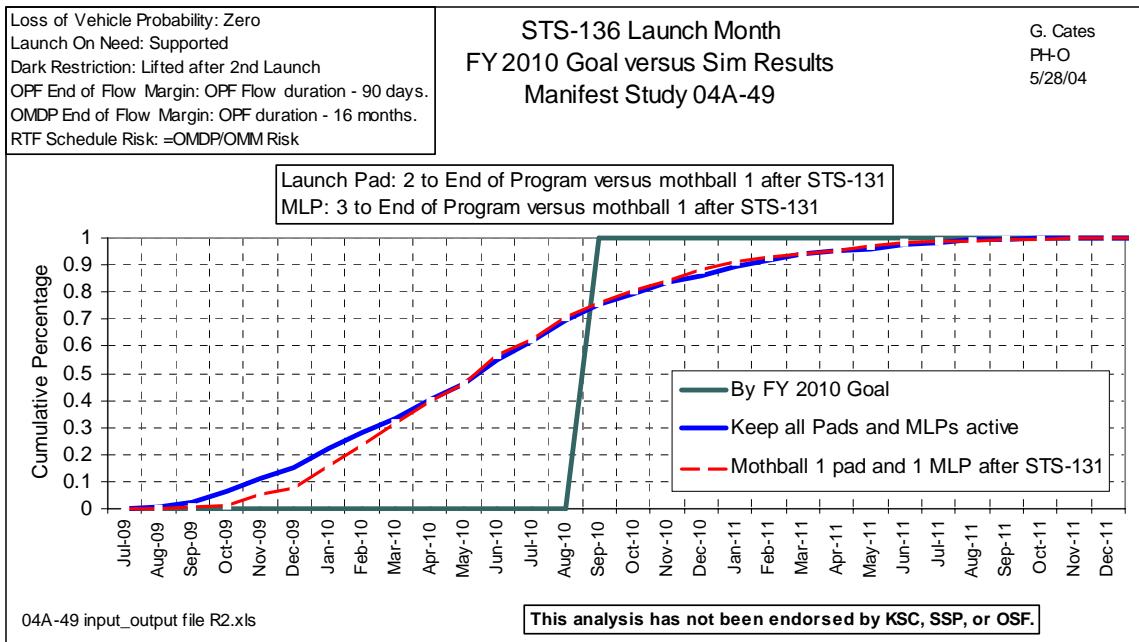

Figure 41: Analysis of 04A-49 Option with S1.O Assumptions

NASA was also interested in the influence of incrementally shutting down facilities after STS-131—the planned last mission of OV-103, which was scheduled to be launched July 3, 2008. The simulation results suggested that this action had only a small affect upon the results. Note how the simulation results overlap for the most part, with the potentially notable exception of the time period August 2009 through February 2010. An analysis of the confidence bands was required to see if this was a significant difference. Figure 42 shows confidence bands during the time period of interest.

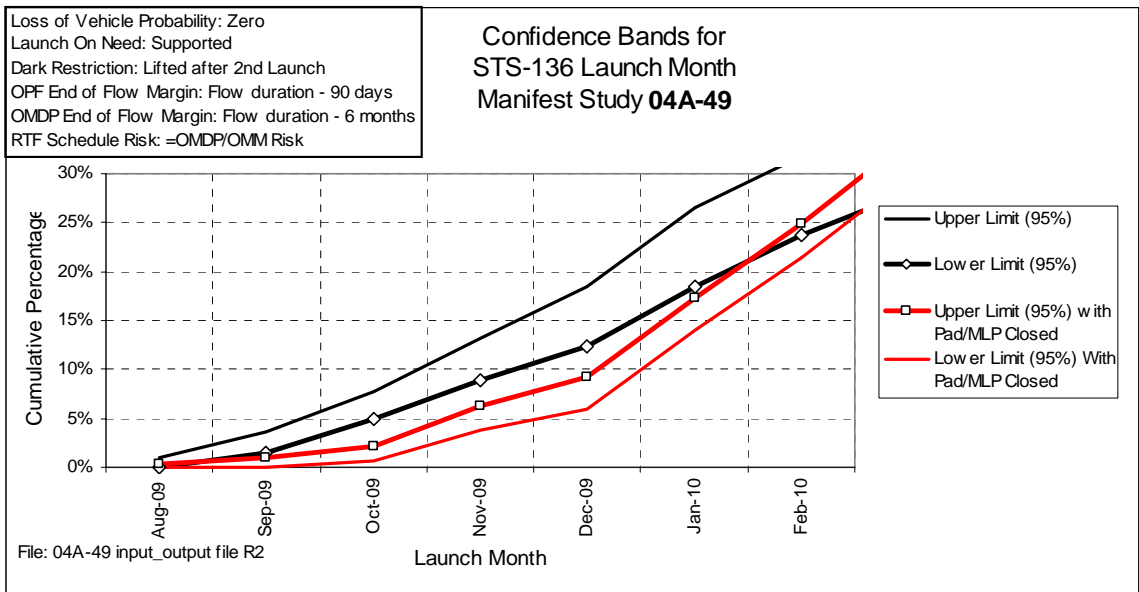

Figure 42: Confidence Bands for STS-136 Launch Date

The confidence bands do not overlap during the time period of September 2009 through January 2010. This indicates that there is a statistically significant benefit to

maintaining the complete set of shuttle facilities.

After May 28th the 04A-49 option was no longer being actively considered by NASA because a 23 mission scenario for completing the Space Station was not considered viable. Consequently, the analysis results produced up until that point were distributed and further analysis of that option was halted.

Section III: Evolution of PAST

After the pilot case study PAST evolved in response to lessons learned and queries from project stakeholders. A recognized weakness of the PAST modeling component in the pilot case study was the length of time required to model alternative scenarios. This weakness led first to the creation of a generic modeling component that could be linked to an Excel input file. Later, the output analysis process was automated in response to requests for faster turnaround time during case studies 2 and 3. As PAST became more widely used project stakeholders desired increased understanding of the process used to perform PAST based analyses. This led to further development of the managerial component. The output analysis component evolved in response to customer requests for a Completion Quantity Distribution Function. These aspects of PAST's evolution are described in greater detail below.

Modeling Automation

During the pilot case study all of the project information had been resident in the simulation model. Consequently, modeling alternative project plans was time consuming. The improved simulation model was structured such that the deterministic project plan input variables could be read from an Excel file. Each project plan of interest could be loaded into its own Excel file. The simulation model could then read the data from the Excel file, run the simulation, and record the results in an output Excel file. This process is displayed in Figure 43.

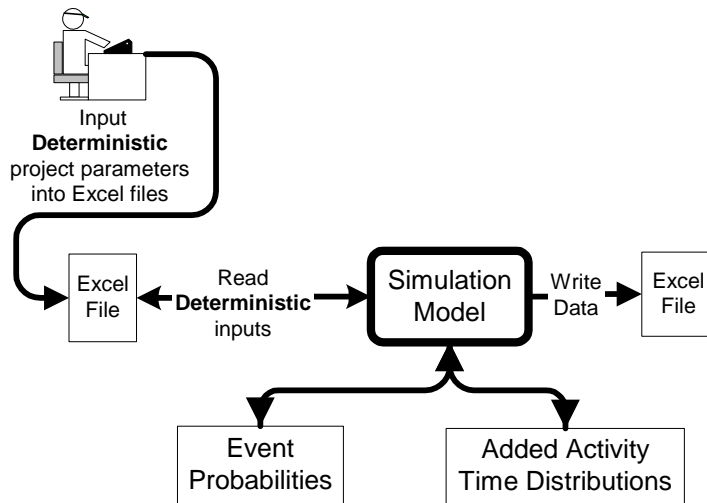

Figure 43: Modeling Component of PAST

This enhanced modeling methodology provided a significant reduction in the time required to perform a PAST analysis. For example, a modeling effort for two different

manifest options that began on November 17, 2003 was completed at 1:00 pm the next day for a total time of approximately 1 day. The time required to model the Node-2 launch date had been on the order of two weeks. The enhanced modeling methodology was used in case studies 2 and 3.

Output Analysis Automation

During case studies 2 and 3 project stakeholders requested increasingly faster turnaround times for analysis of alternatives. Initially a turnaround time of a day or two was acceptable. Later, however, requests for 2 hour turnaround times were made. There was even a request that an update be made in 10 minutes. The response to these customer demands was to automate the Excel portion of the output analysis component of PAST.

When first conceived the output analysis process was not automated. Each time a simulation was run the replication results, usually 1000 data points, were written directly into Excel from the simulation model. Histograms, cumulative distribution functions, and confidence bands were then created from those data points using the graphing and charting functions resident in Excel. This process was particularly tedious and time consuming because it required several actions on the part of the analyst.

It was found, however, that most of the output analysis process could be automated in Excel. The automation process required extensive use of the “COUNTIF” function in Excel. This function counts the number of cells within a specified Range that

meet a specified condition. The range was the simulation output from the 1,000 replications. The given condition was the number of instances in those 1,000 replications in which the project completed within a specified time frame. The results of the COUNTIF function could then be used to create tables and graphs for histograms, cumulative frequency distributions, and confidence bands. Because these tables and graphs were dependent upon the COUNTIF function results they automatically updated each time a new set of simulation results were written into Excel.

Management Issues

The managerial component of PAST both expanded and required greater definition during the time that the case studies were active. This evolution occurred in response to several questions from project stakeholders. First they desired greater understanding of the process of conducting a PAST analysis. This led to the development of a step-by-step process explanation, an estimate of how long the steps take, and an estimate for the level of resources required or scope of the effort. The issue of where the analyst should reside organizationally was also explored. An area that received great attention was the need to establish distribution controls and disclaimers for the analysis results.

PAST: Step-by-Step

In April of 2003 NASA asked for a more detailed explanation of the PAST process and how long a PAST analysis of a manifest option typically takes. This is information that needs to be included during the introductory briefing. It should also be specified in the requirements section of the managerial component of PAST.

Additionally, a summary level step-by-step process, similar to the one described below, should be provided to project stakeholders.

Step 1 in the process is to obtain the manifest option(s) needing to be analyzed. This is typically provided via email, and the option is printed so as to facilitate the next step.

Step 2 is to manually enter the data from the manifest option into Excel. That process takes approximately two hours. The process includes semi-automated error checking in Excel to ensure that the manifest data is entered correctly. This step could be further enhanced by fully automating the transfer of manifest option data into Excel.

Step 3 is to run the model in a deterministic mode just to make sure that the simulation will execute the manifest and achieve the planned launch on the planned launch date. This helps to ensure that the Excel file and the simulation model are a correct representation of the manifest option. If that goes well, then it takes only a few minutes. However, if it doesn't produce the right output, then time is required to correct the mistakes. Sometimes this can take several hours, but usually it is relatively easy to find and fix in an hour or two.

After it is all coded correctly, Step 4 is to run the simulation in the variable mode (stochastic) and the results are written to an Excel file. To run 1,000 replications in the simulation takes approximately 1-2 minutes. Step 4 is repeated for each of the requested scenarios for that manifest. For example, one scenario might assume the daylight launch requirement goes away after the second shuttle launch and an alternative scenario could be that the requirement remains in place for all missions.

Step 5 is to perform the analysis in the Excel output file. This analysis includes producing histograms, cumulative probability curves, and confidence bands. Excel is structured such that these products are produced in a largely automated fashion. The product titles, dates, and assumptions must still be manually edited on the graphics. The products are then checked to see if they make sense i.e. do they look like what was expected. A typical time to perform this analysis, assuming the results look valid, is approximately 1 hour. If the results appear to be invalid, then it may be necessary to return to any of the earlier steps in a trouble shooting mode. The solution to the problem may take only a few minutes, but can take much longer.

Step 6 is to paste the useful charts into a PowerPoint presentation. Components of the PowerPoint presentation include the title chart, assumptions, requested measures of performance, the manifest being analyzed, and the results charts. This process takes about an hour.

Under the best conditions, the time from start to a finished product is 4 to 6 hours. But it can go longer if problems are encountered. The time estimates assume dedicated effort.

Once a particular manifest option is modeled correctly with Excel input file, simulation model, Excel output file, and PowerPoint presentation file, additional runs can be performed very quickly. Less than an hour depending upon quantity of information desired.

The estimate for the total number of manifest options that could be analyzed on a weekly basis was said to be “a few.” That number could be increased if the manual processes could be automated. Those processes were the loading of the manifest option data into input Excel file and the editing of the various figures in the output Excel file.

Scale of Effort

“What is the scale of the effort?” This question relates to how many resources would be dedicated to performing PAST based analysis work became a topic of interest that needed discussion.

A one-person dedicated effort to the manifest analysis effort seemed reasonable for a number of reasons. There was at that time no one else performing this function in the Space Shuttle organization. The level at which this analysis could influence the Space Shuttle and Space Station programs, as well as the interest in PAST by other senior NASA officials indicated that dedicating at least one person to this task was appropriate.

Additional support, beyond one dedicated individual, could be added later if desired to increase the robustness of the service being provided. This growth might

include furthering partnerships with other organizations in NASA where simulation and modeling expertise existed. Consideration could also be given to a modest level of additional staffing to more economically perform the more routine functions. This could actually reduce the cost of providing the service because some of the more tedious tasks, e.g. the manual input into excel, manual input of historical data into Excel, and creating a web site, etc. could be more economically performed by less expensive employees.

Organizational Residence

Another consideration was the location of the service. Should the analysis function remain in a line organization or should it be a Shuttle Program level function or even some form of a NASA Independent Assessment Office function. There were arguments for any of those alternatives. A prime argument for where it currently resides was that the function is probably best done locally where the manifest options are being generated. More generically speaking, performing the service in-house or via acquired temporary consultant service should be considered.

Analysis Distribution Controls

During the case studies concerns were expressed PAST based analyses of Space Shuttle manifests were being distributed external to the Space Shuttle program prior to

their being fully staffed through the Space Shuttle program. Figure 44 helps to illustrate some relevant organizational boundaries within NASA.

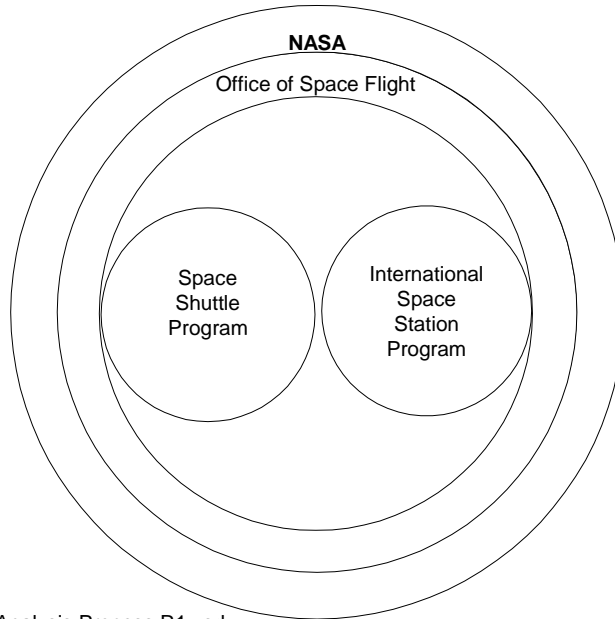

File:
Project Analysis Process R1.vsd

Figure 44: Organizational Hierarchy

The Space Shuttle program is under the direction of the Office of Space Flight.²³ That Office also manages the International Space Station program. The outermost NASA circle represents all other areas of NASA outside the Office of Space Flight. The concern was that an analysis product had gone outside the circle of the Space Shuttle program, and in fact outside the Office of Space Flight circle, without having been fully coordinated. This concern served as catalyst to further develop the managerial component of PAST, primarily to ensure appropriate staffing for PAST analyses.

The Completion *Quantity* Distribution Function Graphic

Interestingly, the Completion *Quantity* Distribution Function, in addition to the Completion *Time* Distribution Function, became a required output product. The use of this product in analyzing Manifest Option 04A-29, under three different assumptions, is illustrated below.

First there was the issue of whether or not the shuttle would be restricted to daylight only launches for the remainder of the program. This possibility was mentioned in NASA's return to flight plans. "For the time being we will launch the Space Shuttle missions in daylight conditions to maximize imagery capability until we fully understand and can mitigate the risk that ascent debris poses to the Shuttle."²⁴ All previous models had been run under the assumption that the daylight only restriction would be lifted after the second mission.

A second modeling assumption was with respect to the need to have a backup shuttle ready to launch a rescue mission within a set time period. "For the first two flights, NASA will ensure that the SSP has the capability to launch a rescue Shuttle mission with the time period that the ISS Program can reasonably predict that the Shuttle crew can be sustained on the ISS."²⁵ The time period was initially estimated to be 90 days, but other time periods could be modeled. The model was also set up to run under the assumption that the need to have a launch-on-need (LON) shuttle might extend to the end of the program.

Finally, there was also interest in including a non-zero probability for loss-of-

vehicle (PLOV) during mission operations. Consequently, the simulation model was set up to run alternatives with PLOV set at either 0 or .01. All previous modeling had discounted the possibility of a non-zero PLOV.

On May 5th the results from these analyses were presented to NASA. Figure 45 shows the CQDF curves representing the number of launches likely to be achieved through the end of Fiscal Year 2010.

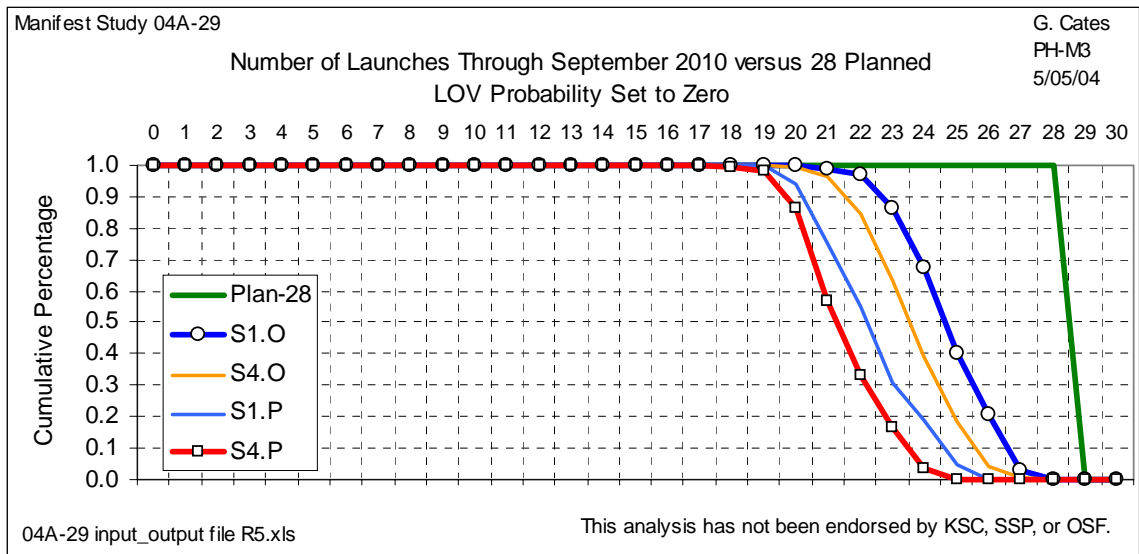

Figure 45: CQDF for Analysis Team

The analysis indicated that manifest option 04A-29 was unlikely to produce the desired result of 28 launches by the end of Fiscal Year 2010. This result held true under a variety of assumptions. The bounding cases at that time were thought to be S1.O (best case) and S4.P (worst case), both of which assumed that the launch on need requirement

continued to the end of the program. The S1.O scenario was defined as the darkness restriction being lifted after the second shuttle mission and included improvements in the way the shuttle program manages schedule margin. These improvements would be enabled by workforce augmentation. The S4.P scenario assumed that the darkness restriction was never lifted, that the shuttle program managed schedule margin in the same manner that they have in the past, and that the workforce would not be augmented.

Figure 46 shows the CQDF simulation results when PLOV is set at .01.

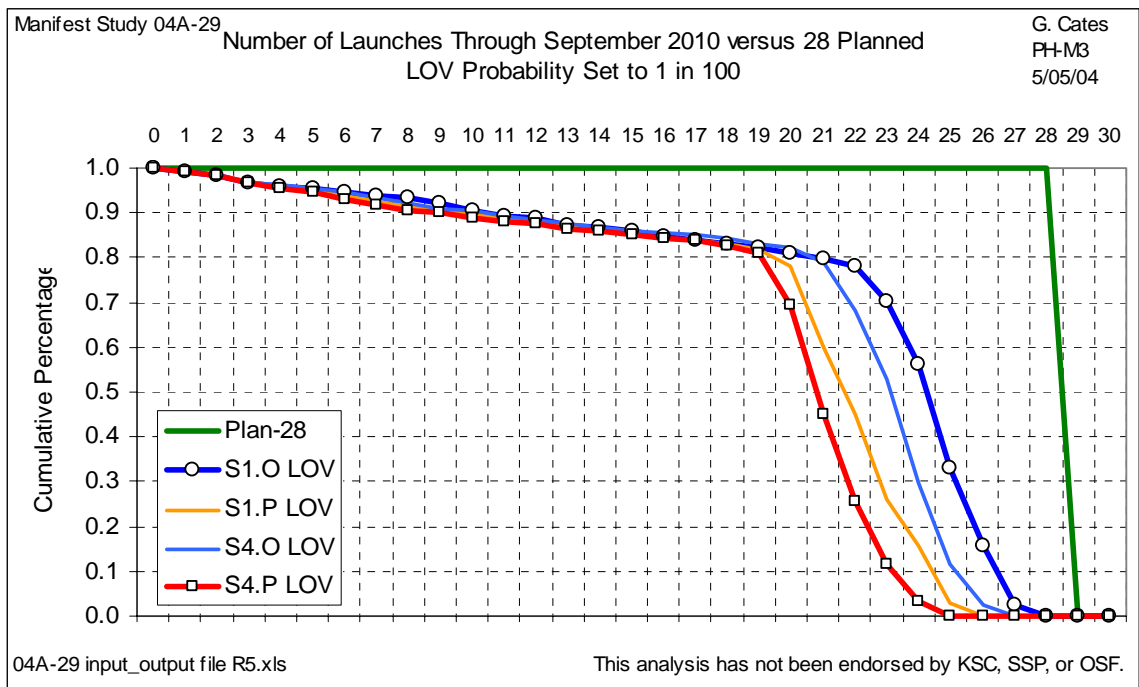

Figure 46: CQDF with PLOV at .01

If the launch-on-need requirement were to go away, then some improvement in

the number of achieved launches by Fiscal Year 2010 could be expected. Figure 47 shows the improvement to the bounding cases, with PLOV set to zero, brought about by elimination of the launch on need requirement. Note that this analysis assumed a launch-on-need requirement of 90 days.

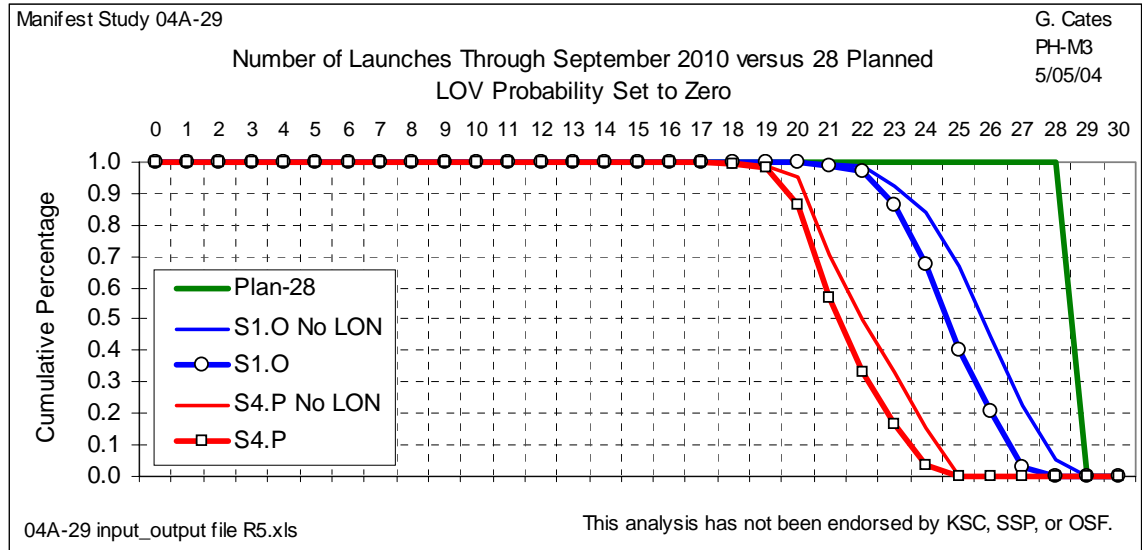

Figure 47: Improvement from Elimination of Launch on Need Requirement

NASA gave “high marks” to this new type of quantitative assessment.

CHAPTER FIVE: CONCLUSION

The Project Assessment by Simulation Technique was found to be an effective tool for supporting various project stakeholders. Use of the PAST methodology, as applied to analyzing the project to assemble the International Space Station, gained a modest level of acceptance within NASA over the time period December 2002 through August 2004. Project stakeholders have a greater understanding of how that project stands with respect to finishing.

During the case studies the methodology was called MAST which stands for “Manifest Assessment Simulation Tool.” The more generic term for the methodology was chosen to be Project Assessment Simulation Technique (PAST) because the methodology is based upon an underlying assumption that *past* performance is likely to be indicative of future results. Use of the word “technique” comes from the PERT, GERT, and VERT methodologies.

Summary of Case Study Results

Recall that the question of interest for the case study was, “How would project stakeholders respond to the Project Assessment by Simulation Technique?” The corresponding proposition was that “Project stakeholders would react positively to the

Project Assessment by Simulation Technique and might, in certain situations, take action to improve project completion performance.” This proposition was found to be true in the case of the pilot case study and subsequently case studies 1 and 2.

In all of those cases the project stakeholders reacted positively to PAST and took or proposed action to improve project completion performance. In the pilot case study weekend work was proposed. In case study 1, lowering of the Space Station was proposed. This proposal was rejected after it was shown, using the PAST methodology, that this would not provide sufficient improvement to overcome other considerations. Work force augmentation was proposed and shown by PAST in case study 2 to provide significant improvement. This information was then used to implement an actual change—i.e. augment the workforce. Project content reduction was also proposed during case study 2 and shown to provide significant improvement to project completion timeliness. There was no recorded stakeholder response for case study 3 because it’s underlying need—the manifest option under consideration—was scrapped.

It is important to note first, however, that the PAST based analysis was not the sole justification for decisions or actions taken by NASA. Assembly of the International Space Station is of such complexity in terms of its technical, political, and safety issues that most decisions and actions require a broad spectrum of decision support tools. PAST became a part of that suite during the case studies.

A majority of the case studies showed a positive response to PAST. As such the potential for PAST to improve project management, at least for the International Space Station assembly project, has been established. It may be said that similar projects should

have the potential to benefit from PAST as well.

Recall that one of the downsides conducting the research as a participant-observer was the potential to introduce bias into the findings and conclusions. As such there could be the potential that the conclusions expressed above are overstated in terms of being too positive. To that concern I would offer the following. PAST, or MAST as called by NASA, was cited as being a “technology infusion success story” by the NASA project stakeholders. This citation was suggested without my involvement.

Observations and Recommendations

During the case study many observations were made and some of these need to be highlighted. Recommendations are offered in response to these recommendations.

Completion Quantity Distribution Function

At the start of the case study, the primary output of PAST was thought to be the project Completion Time Distribution Function. However, during the case study, the generation of a Completion Quantity Distribution Function (CQDF) became important. The CQDF was subsequently found to be so valuable that it was added as a standard output of all subsequent analyses during the case study.

It is recommended, therefore, that future PAST based analysis efforts consider the addition of the CQDF as a standard output product. In the future, other project

stakeholders making use of PAST may come up with requests for novel output products. These customer requests should be given high priority.

Timeliness of Analysis

During the case study it was observed that project stakeholders seemed to desire near real-time results. “If you can’t produce the simulation results in 2 hours then don’t bother.” At that time an input model of that particular manifest option had not been created. That project stakeholder was not supported because the entire process for creating the input file, performing the simulation runs, analyzing the output, and producing output products would take a minimum of 6 hours. However, as a result of this request the output analysis process was automated in Excel. When a subsequent email stating that “I need these results charts updated by 10:00 a.m.” was received at 8:10 a.m. the automated analysis process allowed that request to be met.

Successful implementation of PAST in any real world project management environment may depend upon the speed in which the analysis can be accomplished. Some latitude for a lengthy period of time to develop the first model of a particular project will be expected. However, subsequent analyses of changes to that project’s plans need to be accomplished such that the information is available when project stakeholders demand it.

In response to these observations, it is recommended that future PAST based

analysis efforts place high priority on providing timely products. Automating the modeling and output analysis components of the PAST methodology will facilitate this timeliness. For example, as the case studies progressed greater and greater automation was built into the output Excel files. This enabled the automatic generation of the CTDF, the CQDF, and their associated confidence bands. Within the simulation model of the project, various “switches” were created such that assumptions could be changed easily. The most tedious and time consuming process in PAST during the case study was the manual input of the manifest option data into the Excel input file. Automation in this area was not possible because the manifest options being created used a legacy software system that was not compatible with exporting to Excel.

Politics of Risk Assessment

During the case study it was observed that some project stakeholders became concerned about an analysis showing a low likelihood of completing the Space Station assembly by the end of the decade. This concern may be attributable to the politics of risk assessment.

Large and expensive public projects, such as the project to assemble the International Space Station must take into account political considerations. A project can be cancelled at anytime if congressional support falters. A well intended project risk assessment that portrays a low probability of success with respect to an important project

goal may be used as justification to cancel a project. Given that scenario one can understand the resistance to performing or publishing quantitative project risk assessments especially if the assessment suggests a low likelihood of success. The unfortunate aspect of this political dilemma is that by avoiding quantitative risk analysis, the opportunity to identify critical risk drivers, mitigate those risks, and measure the resulting improvement quantitatively is lost.

Bell and Esch (1989) describe the case of a probabilistic risk assessment by General Electric during the Apollo program. GE, under contract to NASA, performed a quantitative probabilistic risk assessment of the likelihood of success in landing a man on the moon and returning him safely. Their assessment was quite low, less than a 5 percent chance of success. The NASA Administrator believed that this assessment, if publicized, would do irreparable harm. Consequently, NASA stayed away from numerical risk assessments and adopted qualitative risk assessments.

One has to wonder if continuation of GE's quantitative assessment and mitigation of the identified risk drivers from the assessment might have prevented the Apollo 1 fire or the failure of the Apollo 13 mission to land on the moon. Likewise, would better attention to empirical data and quantitative risk assessment have prevented the Challenger accident? In the aftermath of that accident NASA was directed to make use of quantitative probabilistic risk assessments.

Future Research

Future research opportunities could proceed along several different fronts. A case study encompassing the present time frame through assembly completion of the International Space Station and retirement of the Space Shuttle is a natural follow-on to this research. Assuming that PAST is used throughout this period, then there should be substantial empirical evidence as to whether or not PAST provides benefit to project management, at least with respect to one large project. PAST is intended for a wide variety of major projects. Consequently, case studies on the use of PAST on other projects would be desirable. These projects could be in any area, e.g. defense, aerospace, construction, etc. There are also a variety of issues related to the PAST methodology that could be explored. These include the reliance upon historical data and the creation of empirical distributions.

Continued Use of PAST to Support ISS Assembly

On May 7, 2004, the existence of the PAST based analysis was brought up at a meeting with the NASA Administrator. At this meeting it was relayed that achieving 28 flights by the end of FY 2010 would likely be problematic. Consequently, NASA has subsequently been working towards improving the likelihood of completing the assembly of the International Space Station by the end of the decade. In concert with those efforts, PAST is being used in an iterative fashion to determine what it might take to achieve ISS

assembly complete by the end of the decade with higher confidence.

Provided below is an example of how PAST can be used to improve ISS assembly timeliness. Figure 48 is presented to suggest how various actions undertaken by NASA might improve the ISS assembly completion milestone.

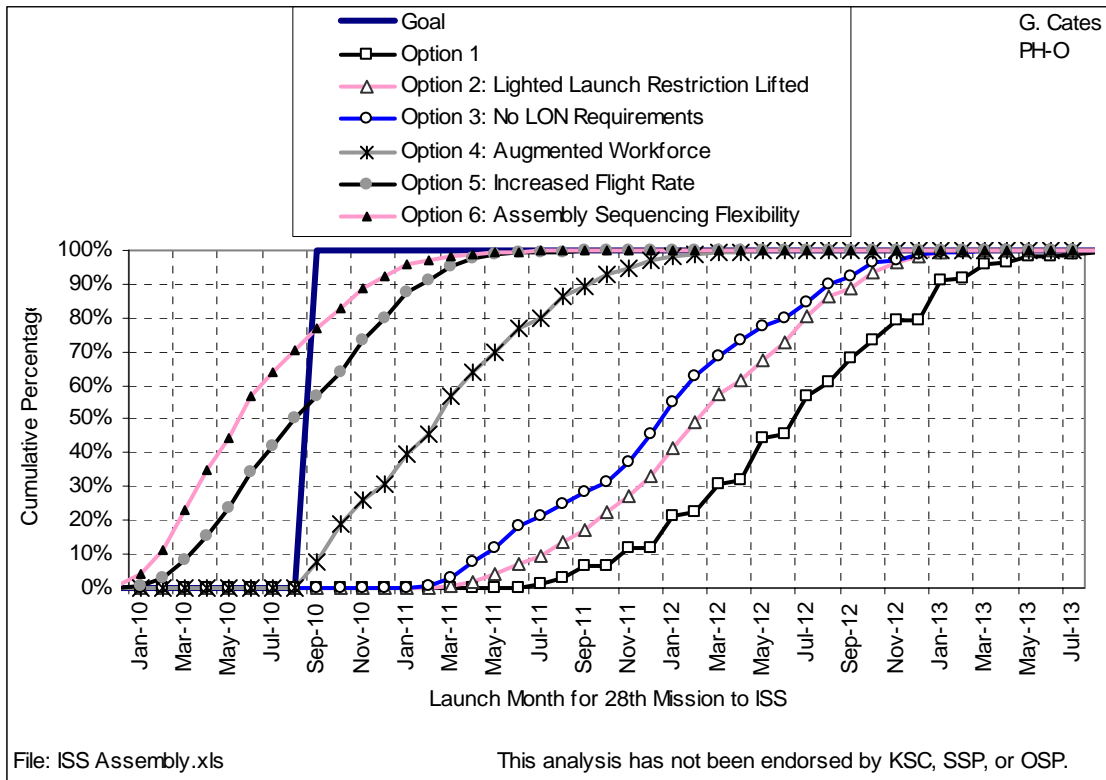

Figure 48: Accelerating ISS Assembly Completion

The goal of achieving ISS assembly completion by the end of the decade is represented by the near vertical line at September 2010. Six options, each having

different input assumptions, were modeled. Option 1 assumes a five flight per year manifest plan with all launches being restricted to daylight and requires that a backup shuttle be ready to launch on need (LON) no more than 90 days after any shuttle has been launched. As shown by the graph, Option 1 has virtually no chance of achieving ISS assembly complete by the end of the decade. At the 50th percentile, assembly complete occurs in the July 2012 timeframe—nearly two years late. The current annual cost for operating the Space Shuttle and building the Space Station is approximately \$6 billion. Consequently, if NASA were to continue with the Option 1 scenario, the expected additional costs to complete the ISS is approximately \$12 billion.

Option 2 lifts the lighted launch restriction after the 2nd shuttle mission. This action improves the ISS assembly completion milestone, as measured by the 50th percentile to February 2012. The savings from the 5-month acceleration could equate to as much as \$2.5 billion. Option 3 is the same as Option 2 with the addition that the requirement to have a LON rescue shuttle goes away after the 2nd shuttle mission. Option 3 is approximately 2 months and \$1 billion better than Option 2.

Option 4 is the same as Option 3 plus it includes an augmented workforce. . This option indicates the augmentation of the workforce, depending upon how it is utilized could accelerate ISS completion by as much as 10 months and save NASA approximately \$5 billion. Given that the cost to augment the workforce for the 7-year period 2004 through 2010 is on the order of \$300 million demonstrates the tremendous benefit achievable by Option 4. Option 4 is the option closest to NASA's ISS assembly planning assumptions as of this writing. However, the strategy for how to utilize the workforce

augmentation has not been fully decided. Consequently, it may not achieve all of the savings shown above. Nonetheless, significant savings are possible.

Option 5 is based upon a 6-flight per year manifest as opposed to the 5-flight per year manifest for the previous 4 options. Given a 6-flight per manifest, the planned launch of the 28th shuttle mission occurs in November of 2009. Under this option there is a 10-month project buffer between the earliest possible project completion date and the desired project completion date. According to Goldratt having a large project buffer is highly desirable and should lead to considerable improvement in project completion timeliness. The simulation results as shown in Figure 48 support this viewpoint. Given option 5, the ISS assembly completion is achieved in the desired time frame at the 50th percentile. Additional funding, beyond that provided for the workforce augmentation of Option 4, would be required in order to carry out Option 5. The quantity of that additional funding had not been estimated as of this writing.

Like Option 5, Option 6 is based upon a 6-flight per year manifest. However, under Option 6 it is assumed that the sequence of shuttle missions can be modified. For example suppose that shuttle mission 20 is delayed such that mission 21 is ready launch sooner. Under all the earlier options mission 21 has to wait for mission 20. In Option 6, however mission 21 could go ahead and mission 20 would launch after words. Under Option 6 the likelihood completing the ISS on time is increased to approximately 75 percent.

Option 6 might appear to be akin to saying that the 21st story of a high rise could be erected before the 20th story has been built. However, in theory, such a scenario is

achievable for ISS assembly. For example, if the component of the ISS in the 20th mission could be moved at the last minute to the shuttle flying the 21st mission, then the on-orbit assembly sequence is unaltered. The only thing that changed was which shuttle delivered the component. In practice, late swapping of mission elements between shuttles is difficult to achieve. Another scenario would be to go ahead and launch the 21st component and then park it temporarily near the station until the 20th component has been installed. In practice, this too would be problematic. Nonetheless, the benefit provided by having sequencing flexibility does indicate that such possibilities deserve further exploration.

PAST and Critical Chain Project Management

Proponents of new project management strategies, such as Eliyahu Goldratt's Critical Chain Project Management, may also use the Project Assessment by Simulation Technique to quantify the benefit of new strategies. For example Goldratt places emphasis on decreasing activity durations within the project so as to create a buffer between the planned project completion time and the desired project completion date. PAST could be used to quantify the influence of such actions.

The PAST Input Analysis Methodology

PAST relies heavily upon having historical data and using that data to create empirical distributions. There are problems with that method that could be explored. First, as noted in the literature, obtaining relevant historical data can be problematic. Consequently, a case study in which one uses expert opinion to create triangular probability distributions would complement the present research. Second, even when one does have sufficient historical data to create reasonable empirical distributions, there can be problems. One problem is that empirical distributions are limited in terms of the extreme values. For example, a project activity in which there has historically been at most only a delay of 20 days may experience a greater delay in the future. Consequently, there may be value to transforming empirical distributions into less bounded theoretical distributions that at least have low probabilities of larger values.

Closing Thoughts

The Project Assessment by Simulation Technique can provide practical value to project stakeholders. First, they can gain greater understanding of when their project is likely to complete versus when it is planned to complete. Secondly, they can also see the influence of varying assumptions or managerial decisions. When opportunities to make improvements to the project are considered they will be able to quantify the benefits of implementing those opportunities. For example, one project strategy might be to install management reserve within the individual project activities. The corresponding Project

Completion Distribution Function will quantify the effect of this strategy. Likewise, when things go awry managers will be able to measure the negative influence on the project's completion time. This will provide them with earlier opportunities to take corrective actions. A corrective action might be to use overtime to reduce or "crash" an activity's duration. The resulting PCDF will quantify the corrective influence of that action.

The Project Assessment by Simulation Technique as developed in Chapter 3 and described in the case studies of Chapter 4 provides a constructive example for future PAST practitioners and project stakeholders alike. PAST practitioners can use it as a guide to providing project stakeholders with understandable, statistically valid, and accurate assessments of project completion dates, and then to make appropriate comparisons of alternatives. Project stakeholders can use it so as to better understand the potential benefit that may be derived from such analysis. Successful implementation of PAST into the management of large projects can improve project completion performance.

END NOTES

¹ Joseph J. Moder, Cecil R. Phillips, and Edward W. Davis, *Project Management with CPM, PERT and precedence diagramming*, 3rd Edition, Von Nostrand Reinhold Company, NY, 1983, pp. 12-13.

² Richard I. Levin and Charles A. Kirkpatrick, *Planning and Control with PERT/CPM*, McGraw-Hill Book Company, 1966, pgs. 2-8.

³ Johnson, Lyndon Baines, *The Vantage Point, Perspectives of the Presidency, 1963-1969*, Holt, Rinehart and Winston, 1971, page 281.

⁴ Galway, L., "Quantitative Risk Analysis for Project Management: A Critical Review," RAND working paper, The RAND Corporation, WR-112-RC, Santa Monica, California, Feb. 2004, pg. 15.

⁵ Project Management Institute, *Project Management Body of Knowledge*, PMBOK Guide, 2000 pg. 139.

⁶ Stephan A. Devaux, *Total Project Control: A Manager's Guide to Integrated Project Planning, Measuring, and Tracking*, John Wiley & Sons, Inc., 1999, pgs 190-191.

⁷ Joseph J. Moder, Cecil R. Phillips, and Edward W. Davis, *Project Management with CPM, PERT and precedence diagramming*, 3rd Edition, Von Nostrand Reinhold Company, NY, 1983, pp. 13.

⁸ Joseph J. Moder, Cecil R. Phillips, and Edward W. Davis, *Project Management with CPM, PERT and precedence diagramming*, 3rd Edition, Von Nostrand Reinhold Company, NY, 1983, pp. 12-13.

⁹ Richard I. Levin and Charles A. Kirkpatrick, *Planning and Control with PERT/CPM*, McGraw-Hill Book Company, 1966, pgs. 2-8.

¹⁰ Richard I. Levin and Charles A. Kirkpatrick, *Planning and Control with PERT/CPM*, McGraw-Hill Book Company, 1966, pg. 7.

¹¹ D.G. Malcolm, J.H. Roseboom, and C.E. Clark, "Application of a Technique for Research and Development Program Evaluation," *Operations Research*, Vol. 7, Issue 5 (Sep-Oct 1959) pp. 650-651.

-
- ¹² Richard I. Levin and Charles A. Kirkpatrick, *Planning and Control with PERT/CPM*, McGraw-Hill Book Company, 1966, pp. 25-45 and chapter 7.
- ¹³ Goldratt, Eliyahu, M., *Critical Chain*, The North River Press, Great Barrington, MA, pg. 41.
- ¹⁴ Lawrence P. Leach, *Critical Chain Project Management*, Artech House, 2000, pg. 259.
- ¹⁵ Mollaghasemi, "Introduction to Simulation Modeling Seminar," 1999
- ¹⁶ Kelton, Sadowski, and Sadowski, *Simulation with Arena*, McGraw-Hill Series in Industrial Engineering and Management Sciences, WCB/McGraw-Hill, 1998, pgs. 173 and 444.
- ¹⁷ Yin, Robert K., *Case Study Research: Design and Methods*, Third Edition, Applied Social Research Methods Series, Vol. 5, SAGE Publications, Thousand Oaks, California, 2003, pg. 35.
- ¹⁸ Gehman, Harold W. Jr., et al., *Report of the Columbia Accident Investigation Board*, Vol. 1, August 2003, pg. 131.
- ¹⁹ Gehman, Harold W. Jr., et al., *Report of the Columbia Accident Investigation Board*, Vol. 1, August 2003, pp. 136-7.
- ²⁰ Gehman, Harold W. Jr., et al., *Report of the Columbia Accident Investigation Board*, Vol. 1, August 2003, pg. 139.
- ²¹ On December 11, 2003, the NASA Inspector General announced an audit intended to review activities planned to address the recommendation made by the Columbia Accident Investigation Board (CAIB) for adopting and maintaining a Shuttle flight schedule consistent with available resources (CAIB recommendation R6.2-1). This audit was numbered A-04-011-00.
- ²² The President's FY 2005 Budget Request for the National Aeronautics and Space Administration requests \$4.319 billion for the Space Shuttle and \$1.863 billion for the International Space Station.
- ²³ The Office of Space Flight became the Space Operations Mission Directorate in 2004.
- ²⁴ *NASA's Implementation Plan for Space Shuttle Return to Flight and Beyond*, NASA, April 26, 2004, page xvi.
- ²⁵ *NASA's Implementation Plan for Space Shuttle Return to Flight and Beyond*, NASA, July, 28, 2004, page 2-5.

LIST OF REFERENCES

- Adlakha, V.G. and Kulkarni, V.G., "A classified bibliography of research on stochastic PERT networks: 1966-1987, *INFOR*, 27 pp. 272-296 (1989)
- Arisaw, S. and Elmaghraby, S.E., "Optimal Time-Cost Tradeoffs in GERT Networks," *Management Science*, Vol. 18, No. 11, July 1972
- Banks, J., Carson J.S. II, Nelson, B.L., and Nicol, D.M., *Discrete-Event System Simulation*, 3rd edition, Prentice Hall International Series in Industrial and Systems Engineering, 2001
- Barton, R.R. and Schruben, L.W., "Resampling Methods for Input Modeling," *Proceedings of the 2001 Winter Simulation Conference*, B.A. Peters, J.S. Smith, D.J. Medeiros, and M.W. Rohrer, eds, (372-378)
- Bedford, Tim, and Cooke, Roger, *Probabilistic Risk Analysis: Foundations and Methods*, Cambridge University Press, Cambridge, UK, 2001
- Bell, T.E. and Esch, K., "The Space Shuttle: a case of subjective engineering," *IEEE Spectrum*, June 1989 pp. 42-46
- Cates, G.R. "Node-2 Manifest Margin Assessment With Initial Simulation Results," PowerPoint Presentation, NASA, December 12, 2002
- Cook, T.M. and Jennings, R.H., "Estimating a project's completion time distribution using intelligent simulation methods," *Journal of the Operational Research Society*, Volume 30 (12), pp. 1103-1108 (1979)
- Devaux, Stephan A., *Total Project Control: A Manager's Guide to Integrated Project Planning, Measuring, and Tracking*, John Wiley & Sons, Inc., 1999
- Dodin, B.M., "Bounding the project completion time distribution in PERT networks," *Operations Research*, 33, pp. 862-881 (1985)
- Elmaghraby, S., *Activity Networks*, Wiley, New York, 1977
- Elton, J. and Roe, J., "Bringing Discipline to Project Management," *Harvard Business Review*, Mar-Apr 1998, pp. 153-159
- Fatemi Ghomi, S.M.T. and Rabbani, M., "Approximating completion time distribution function for stochastic PERT networks," *Proceedings of the 5th Annual International Conference on Industrial Engineering—Theory, Applications and Practice*, Dec. 13-15, Hsinchu, Taiwan

- Fleming, Q. W. and Koppelman J. M., *Earned Value Project Management*, 2nd Edition, Project Management Institute, 2000
- Fondahl, J.W., "Non-computer approach to the critical path method for the construction industry," Prepared under Contract No. NBy-17798 for the Bureau of Yards and Docks, U.S. Navy, Stanford University Department of Civil Engineering, Technical Report 9, November, 1961, Revised 1962
- Forrester, J.W., 1961, "Industrial dynamics," *MIT Press*, Cambridge
- Fulkerson, D.R., "Expected Critical Path Lengths in PERT Networks, prepared for United States Air Force Project RAND, The Rand Corporation, Memorandum RM-3075-PR, Mar. 1962
- Galway, L., "Quantitative Risk Analysis for Project Management: A Critical Review," RAND working paper, The RAND Corporation, WR-112-RC, Santa Monica, California, Feb. 2004
- Gantt, H. *Organizing for work*, Harcourt, Brace & Hove, New York, 1919
- Goldratt, Eliyahu M., *Critical Chain*, North River Press, 1997
- Goldratt, Eliyahu M., *The Goal*, North River Press, 1984
- Gutierrez, G.J. and Kouvelis, P., "Parkinson's Law and Its Implications for Project Management," *Management Science*, Vol. 37, No. 8, Aug. 1992, pp. 990-1001
- Hagemann, A.G., "Use of the Critical Chain Project Management Technique at NASA, Langley Research Center," *The 20th Conference on Digital Avionics Systems (DASC)*, Vol. 1, Oct. 14-18, 2001, pages 4B1/1-10
- Hebert, J.E., *Critical path analysis and a simulation program for resource-constrained activity scheduling in GERT project networks*, Purdue University, PhD dissertation, 1975
- Hill, L.S., "Some Possible Pitfalls in the Design and Use of PERT Networking," The Rand Corporation, Memorandum P-3038, Jan. 1965
- Hoeting, J. A., Madigan, D., Raftery, A.E., and Volinsky, C.T. (1999) "Bayesian Model Averaging: A Tutorial (with discussion)," *Statistical Science*, 14:4, 382-417.
- Howick, S., "Should System Dynamics be used to Model Disruption and Delay for Litigation? An Exploration of Criteria," Strathclyde Business School, Scotland, Management Science, Theory, Method, and Practice, Research Paper No. 2002/1
- Johnson, Lyndon Baines, *The Vantage Point, Perspectives of the Presidency, 1963-1969*, Holt, Rinehart and Winston, 1971
- Jaraiedi, M., Plummer, R.W. and Aber, M.S., "Incentive/Disincentive Guidelines for Highway Construction Contracts," *Journal of Construction Engineering and Management*, Vol. 121, No.1, Mar, 1995, pp. 112-120
- Kamburoski, J., Normally distributed activity durations in PERT networks," *Journal of*

- Operational Research Society*, 36, pp. 1051-1057 (1985)
- Kelly, J., "Critical Path Planning and Scheduling: Mathematical Basis," *Operations Research*, Vol. 9, No. 3, May-June-1961, pp. 296-321
- Kelton, W.D., Sadowski, R.P., and Sadowski, D.A., *Simulation with Arena*, McGraw-Hill Series in Industrial Engineering and Management Science, McGraw-Hill, 2001
- Kelton, W.D., Sadowski, R.P., and Sadowski, D.A., *Simulation with Arena*, 2nd edition, McGraw-Hill Series in Industrial Engineering and Management Science, McGraw Hill, 2001
- Kidd, J.B., "A Comparison Between the VERT Program and Other Methods of Project Duration Estimation," *OMEGA International Journal of Management Science*, Vol. 15, No.2, pp 129-134, 1987
- Kidd, J.B., "Do today's projects need powerful network planning tools?" *International Journal of Production Research*, Vol. 29, No. 10, pp 1969-1978, (1991)
- Kleindorfer, G.B., "Boundary distributions for a stochastic acyclic network," *Operations Research*, 20, pp. 800-812, (1971)
- Kljajic, Miroljub, Bernik, I., and Skraba A., "Simulation Approach to Decision Assessment in Enterprises," *Simulation*, Oct. 2000, pgs. 199-210
- Law, A.M. and Kelton, W.D., *Simulation Modeling and Analysis*, 3rd edition, McGraw Hill, 2000
- Leach, L.P., *Critical Chain Project Management*, Artech House, 2000
- Lee, S.M., Moeller, G.L, and Digman, L.A., *Network Analysis for Management Decisions*, Kluwer-Nijhoff Publishing, 1982
- Leigh Givens Filiatrault, C. and Peterson C.D., "Five Behaviors That Can Reduce Schedule Risk," *Proceedings of the Project Management Institute Annual Seminars and Symposium*, Sep 7-16, 2000, Houston, Texas, USA
- Levin, Richard I. and Charles A. Kirkpatrick, *Planning and Control with PERT/CPM*, McGraw-Hill Book Company, 1966
- Lindsey, J.H. II, "Notes on Combinatorial Mathematics: An Estimate of Expected Critical Path Length in PERT Networks," prepared for United States Air Force Project RAND, The Rand Corporation, R-544-PR, Oct. 1970
- MacCrimmon, K.R. and Ryavec, C.A., "An analytical study of the PERT assumptions," *Operations Research*, Vol. 12, 404-421, (1965) See also Rand Research Memorandum RM-3408-PR (December 1962)
- MacCrimmon, K.R. and Ryavec, C.A., "An analytical study of the PERT assumptions," prepared for United States Air Force Project RAND, The Rand Corporation, Memorandum RM-3408-PR, Dec. 1962
- Malcolm, D.G., "Application of a technique for research and development program

- evaluation,” *Operations Research*, Vol. 7, 646-669 (1959)
- Martin, J.J., “Distribution of time through a directed acyclic network,” *Operations Research*, 13, pp. 46-66 (1965)
- Moder, J., and C. Phillips, *Project Management with CPM and PERT*, Van Nostrand Reinhold, New York, 1964
- Moder, J., and C. Phillips, *Project Management with CPM and PERT*, 2nd edition, Van Nostrand Reinhold, New York, 1970
- Moder, J., with C. Phillips and E. Davis, *Project Management with CPM, PERT, and Precedence Diagramming*, 3rd edition, Van Nostrand Reinhold, New York, 1983
- Moeller, G.L. and Digman, L.A., “Operations Planning with VERT,” *Operations Research*, Vol. 29, Issue 4, July-Aug. 1981, pp. 676-697
- Moeller, G.L., 1972. “VERT,” Technical Papers: Twenty-Third Institute Conference and Convention, American Institute of Industrial Engineers
- Morris, P.W.G., *The Management of Projects*, London, Thomas Telford, first published 1994, paperback edition, 1997
- NASA, NASA’s Implementation Plan for Space Shuttle Return to Flight and Beyond, Vol.1, Revision 2.1, National Aeronautics and Space Administration, July 28, 2004
- Newbold, Robert C., *Project Management in the Fast Lane: Applying the Theory of Constraints*, St. Lucie Press, 1998
- Ng, S.-H., and Chick, S.E., “Reducing Input Parameter Uncertainty for Simulations,” *Proceedings of the 2001 Winter Simulation Conference*, B.A. Peters, J.S. Smith, D.J. Medeiros, and M.W. Rohrer, eds, (364-370).
- Ottjes, J.A. and Veeke, H.P.M., “Project Management With Simulation: A Critical View on the Critical Path,” *Proceedings of the ICSC Symposia on Intelligent Systems & Applications (ISA’2000)*, December 2000, Wollongong Australia [ICSC], ISBN 3-906454-24-X.
- Pegden, D.C., Shannon, R.E., and Sadowski, R.P., *Introduction to Simulation Using SIMAN*, 2nd edition, McGraw-Hill, Inc., 1995
- Pinto, J.K., “Some constraints on the Theory of Constraints: Taking a Critical Look at the Critical Chain,” *PM Network*, Project Management Institute, August 1999, pp. 49-51.
- Pritsker A.A.B. and Happ, W.W., “GERT: Graphical evaluation and review technique, Part I, fundamentals,” *Journal of Industrial Engineering*, Vol. 17 (5), 267-274 (1966)
- Pritsker A.A.B. and Whitehorse, G.E., “GERT: Graphical evaluation and review technique, Part II, probabilistic and industrial engineering applications,” *Journal of Industrial Engineering*, Vol. 17 (6), 293-301 (1966)

- Pritsker, A.A.B., "GERT: Graphical Evaluation and Review Technique," The RAND Corporation, RM-4937-NASA, Santa Monica, California 1966
- Pritsker, A. Alan B., *Modeling and analysis using Q-GERT networks*, Wiley, New York, NY, 1979
- Project Management Institute, *A Guide to the Project Management Body of Knowledge*, (PMBOK® Guide), Project Management Institute, 2000
- Rathe, A.W. (ed), *Gantt on management*, American Management Association, New York, 1961.
- Ringer, L. J., "Numerical operators for statistical PERT critical path analysis," *Management Science*, 16, pp. 136-143 (1969)
- Roberts, B., Smith, C., and Frost, D., "Risk-based decision support techniques for programs and projects," *Acquisition Review Quarterly*, Spring 2003 Defense Acquisition University Press
- Robillard, Pierre, and Trahan, Michel, "The Completion Time of PERT Networks," *Operations Research*, Vol. 25, No. 1, Jan-Feb 1977, pp. 15-29
- Sapolsky, H.M., *The Polaris System Development: Bureaucratic and Programmatic Success in Government*, Harvard University Press, Cambridge, MA, 1972
- Schuyler, John, *Risk and Decision Analysis in Projects*, 2nd Edition, Project Management Institute, 2001
- Sculli, D., "The completion time of PERT networks," *Journal of Operational Research Society*, 34, pp. 155-158 (1983)
- Sheppard, M., and Cartwright, M., "Predicting with Sparse Data," *IEEE Transactions on Software Engineering*, Vol. 27, No. 11, November 2001, 987-998
- Simmons, L.F., "Project Management-Critical Path Method (CPM) and PERT Simulated with ProcessModel," *Proceedings of the 2002 Winter Simulation Conference*, E. Yücesan, C.-H. Chen, J.L. Snowdon, and J.M. Charnes, eds, (1786-9)
- Sterman, J.D., "System Dynamics Modeling for Project Management," *Sloan School of Management*, MIT, Cambridge MA, 1992
- Taha, Hamdy, A., *Operations Research, An Introduction*, 5th Edition, MacMillan, 1992
- Tversky, A. and Kahneman, D., "Judgment under Uncertainty: Heuristics and Biases," *Science*, Vol. 185, No. 4157, 27 September 1974, 1124-1131
- Van Slyke, R., "Uses of Monte Carlo in PERT," prepared for United States Air Force Project RAND, The Rand Corporation, Memorandum RM-3367-PR, Feb. 1963
- Van Slyke, R.R., Monte Carlo methods and the PERT problem," *Operations Research*, 11, pp. 839-860 (1963)
- Vose, David, *Quantitative Risk Analysis: A Guide to Monte Carlo Simulation Modeling*,

- John Wiley & Sons, England, 1996
- Walker, M.R. and Sawyer, J.S., "Project Planning and Scheduling," Report 6959, E.I. duPont de Nemours and Co., Wilmington, Delaware, March 1959
- Williams, D.L., Finke, D.A. Medeiros, D.J., "Discrete Simulation Development for a Proposed Shipyard Steel Processing Facility," *Proceedings of the 2001 Winter Simulation Conference*, B.A. Peters, J.S. Smith, D.J. Medeiros, and M.W. Rohrer, eds, (882-887).
- Williams, Terry, "A classified bibliography of recent research relating to project risk management," *European Journal of Operational Research*, pp. 18-38 (1995)
- Yin, Robert K., *Case Study Research: Design and Methods*, Third Edition, Applied Social Research Methods Series, Vol. 5, SAGE Publications, Thousand Oaks, California, 2003
- Yongyi Shou and Yeo, K.T., "Estimation of Project Buffers in Critical Chain Project Management," *International Conference on Management of Innovation and Technology (ICMIT)*, IEEE, pages 162-167, 2000
- Zouaoui, F. and Wilson J.R., "Accounting for Input Model and Parameter Uncertainty in Simulation," *Proceedings of the 2001 Winter Simulation Conference*, B.A. Peters, J.S. Smith, D.J. Medeiros, and M.W. Rohrer, eds, (290-299)
- Zouaoui, F. and Wilson J.R., "Accounting for Parameter Uncertainty in Simulation Input Modeling," *Proceedings of the 2001 Winter Simulation Conference*, B.A. Peters, J.S. Smith, D.J. Medeiros, and M.W. Rohrer, eds, (354-363)