

HEALTHCARE TRANSITIONS AND THE AGING POPULATION:
A FRAMEWORK TO MEASURE THE VALUE OF RAPID REHABILITATION

by

DIANNE MORROW ROSS
B.S.N. University of Texas at Arlington, 1980
M.S. University of Central Florida, 1999

A dissertation submitted in partial fulfillment of the requirements
for the degree of Doctor of Philosophy in Public Affairs
in the College of Health and Public Affairs
at the University of Central Florida
Orlando, Florida

Spring Term
2008

Major Professor: Aaron Liberman

©2007 Dianne Morrow Ross

ABSTRACT

Healthcare services for the aging population in the United States are a complex configuration of acute healthcare organizations, and post acute nursing facilities, home healthcare, and community based services. The system encompasses all services that imply the need for clinical, medical, or professional judgment (Baldrige National Quality Program, 2006). Most Americans believe the system exists to provide preventive services, management for chronic conditions, and health care services to meet the needs of the people (National Committee for Quality Assurance (NCQA), 2004). However, the healthcare delivery system is fragmented across a broad array of settings (Coleman, Smith, Frank, Min, Parry, & Kramer, 2004), plagued by gaps in quality of care, and does not provide optimal care to the majority of American citizens (NCQA, 2004). As a result, national efforts are focused on the identification of quality indicators, performance measures, and the driving need for consensus standards across a multiplicity of providers, payers, and stakeholders. The overarching focus of this effort is to bridge the gaps in health care quality, and reduce documented disparities for vulnerable populations (National Quality Forum (2004).

Healthcare transitions occur as patients receive a broad range of services across a multiplicity of providers, payers, and settings. Aging patients > 65 are most vulnerable during these transitions. A poorly executed transition can result in complications for the patient, duplication of tests and services, discharge delays, increased lengths of stay, early readmissions to the acute care setting, frustration for families and care givers, and dissatisfaction with overall services. Management of care and accountability across

settings is limited and patients are falling through the cracks in the foundation of the healthcare system (Covinsky, 2003).

The intent of this research was to examine healthcare transitions for patients > 65 admitted to a large acute healthcare system, and to identify measurable quality indicators for an innovative delivery model designed to optimize early discharge from the hospital through rapid rehabilitation. This was a quasi-experimental, cross-sectional design measured at the patient level. The research included a total sample of 250 patients representing both the intervention and the control group. The intervention group consisted of 100 patients who were rapidly discharged to a transitional care facility in the community, and 150 patients randomly selected to a control group that did not transition to rapid rehabilitation. The groups were matched as closely as possible by age, gender, race, primary diagnoses, and the complexity of case. Inefficiency was measured by 3 indicators (1) length of stay, (2) total expenses before contractual allowances, and (3) discharge delays from the hospital. Ineffectiveness was measured by 3 indicators: (1) readmission within 30 days, (2) patient safety with falls serving as the proxy, and (3) overall patient satisfaction. Descriptive analysis was performed utilizing SPSS 15.0. Path analysis was method of choice for data analysis and AMOS 7.0 was utilized for the measurement model.

Descriptive analysis found a broad range of diagnosis related groups across 183 women and 67 men with a mean age of 80 for both groups. Initial analysis found the intervention group had a mean length of stay of 9.17 days, and experienced 20 readmissions. The control group had a mean length of stay of 6.77 days, and 30 readmissions. The statistical analysis suggested length of stay and cost of healthcare

services are statistically significant indicators at the 0.05 or lower level and that patient safety has the potential to be developed as an indicator for effective outcomes.

The identification of quality indicators, measurement of efficiency and effectiveness, and establishing predictors for successful healthcare transitions is dependent on the quality and integrity of data abstracted from hospital information systems, accuracy of information in patient records, and the consensus of standards and definitions across a multiplicity of stakeholders. Further research and collaboration is necessary to ensure that patient transition to innovative care programs such as rapid rehabilitation is based on well-defined patient selection criteria. The intent of the methodologies and quality indicators explored in this research supports the increasing need to ensure that inferences and quality measurements drawn from healthcare information is based on valid, reliable, and well defined data sources (Pan, Fergusson, Schweitzer, & Hebert, 2005).

This research suggests hospitals are making steady progress to overcome challenges to safe, quality health services as outlined by the Institute of Medicine (2001) for system redesign, but finds specific implications for hospital leadership. There is a need to thread evidence based practice initiatives into hospital and clinical structures to accommodate new delivery models, processes, and case management. Health services information needs to be housed in a central repository or data warehouse to increase transparency of reportable information across systems and to ensure that valid and reliable information is utilized to draw inferences about performance of hospital systems (Selden & Sowa, 2004) and that quality measurements are established to ensure a scientific foundation for the management of healthcare services (Wan, 2002).

This dissertation is dedicated to my husband Randy Ross, who provides steadfast support for me, for our family, friends, and others through his responsible nature, and giving heart. I have loved you forever, and you are...”still the one”.

To my daughters Leigh and Timi, you are my spirit, the love in my heart, my true north, the wind beneath my wings, and the women I most admire and aspire to be like. Now that dissertation is finished, let’s go shopping for shoes, return to Savannah, and take the children snow skiing and to the beach! You are my best achievement in life.

To my grandchildren, Lane, Katie and Ava, who provide love and joy beyond any quantifiable measure. You are a joyful respite from this work, and provide profound hope for the future of our families and generations. The world is better because of you.

To my sister, Carol who provides unwavering support, listens without judgment, and counsels with knowledge that only a sister can possess, and to my brother Bob who responded to me at all hours of the night via instant email when I needed a break from research and to hear a friendly voice while our families were sleeping.

To my dog Betsy who remained with me at all hours of day and night and knows my character best, but loves me despite imperfections and long hours of dissertation.

To previous generations of our family who exemplified strong family bonds, ethical values, commitment to citizenship and community, and whose lives were touched by compassionate health care professionals and lost because of their experiences with clinical errors and cracks in the foundation of our healthcare system.

ACKNOWLEDGMENTS

This dissertation has been an arduous journey and the successful completion is the result of support and guidance received from many talented and dedicated academic professionals, doctoral program peers, professional colleagues, and friends. To my dissertation committee, please accept my sincere appreciation for many hours in class, wisdom of your counsel, experience, and unwavering belief that I would eventually finish the document and graduate. Individually you provided very different talents to this dissertation, and I will always wish that I had invested more time with each of you: Dr. Aaron Liberman, Chair, you are my Morrie, I look forward to no class, no grades, just life long learning. Dr. Myron Fottler, thank you for teaching me to draw my vision with boxes and arrows, and to invert hypotheses. Dr. Timothy Rotarius, you read this dissertation thoroughly, special thanks for clarifying small points that made big difference. Dr. Thomas Wan, and Dr. Ning Jackie Zhang, you encouraged my novice skills with structural equation models; I wish we had met sooner, and had more time. In addition to dissertation committee, I would like to thank Dr. Eileen Abel who, provided enthusiasm, pedagogy references, and less “the” in my dissertation. Dr. Lynn Unruh, thank you for those many hours of independent study at Einstein’s. Dr. Larry Martin, thank you for linking public affairs and national agenda to my dissertation subject. I would like to acknowledge the skills and unwavering work of Margaret Mlachak who provided guidance, and response to countless communications.

Finally, to my editor Katie Grigg, we have never met, but I know you are talented, professional, responsive, and funny. You have contributed much more than perfect editorial work to this dissertation; you bestowed hope and confidence with humor.

TABLE OF CONTENTS

LIST OF FIGURES.....	xii
LIST OF TABLES.....	xiii
LIST OF ACRONYMS/ABBREVIATIONS	xiv
CHAPTER ONE: INTRODUCTION.....	1
Environment of Healthcare Services.....	1
Aging of the Population	2
Economics and Aging	3
Healthcare Transitions and Processes	5
Fragmentation of Care	5
Donabedian Framework.....	6
Specification of Problem	7
Functional Decline of Aging Patients.....	8
Resources and Aging Population	9
Quality and Integrity of Data.....	10
Paucity of Transitions Research.....	12
Strategic Interventions	12
Bundling of Stakeholders	13
National Quality Forum	13
National Database of Nursing Quality Indicators.....	14
Emergence of New Delivery Systems	14
Rehabilitation for Aging Population	16
Purpose of Research	17
Description of Research Setting	18
Rapid Rehabilitation as Intervention.....	19
Specification of Study Variables	20
Questions and Hypotheses.....	22
Definition of Constructs	22
Questions to be Investigated.....	23
Hypotheses.....	23
Summary and Significance of Study	24
CHAPTER TWO: THEORETICAL FRAMEWORK AND LITERATURE REVIEW	26
Theoretical Framework	26
Organizational Theory	27
Theory of Servant Leadership	28
Theory of the Learning Organization.....	30
Theoretical Framework and Study Hospital	31
Literature Review.....	32
Health and Public Affairs	33
Hospitals as Organizations	34
Market Forces	35
Competition for Resources.....	37
Healthcare Services in State.....	38
Patient Centered Care Management	39

Reliance on Formal Care	40
Transforming Healthcare Delivery System	41
Demonstration Projects	41
Rapid Rehabilitation and Aging Population.....	43
Barriers to Health Service Data Sets	44
Accountability for Hospital Data Sets	46
Resolving Barriers to Research.....	46
Consensus of Standards and Measurements	47
Summary	47
CHAPTER THREE: RESEARCH METHODOLOGY	49
Measurements in Healthcare Transitions	50
Research Design and Framework	51
Specification and Operational Definitions of Study Variables	51
Exogenous, Independent Variable and Intervention.....	54
Latent Constructs	54
Endogenous, Dependent Variables.....	55
Efficiency Indicators	55
Effectiveness Indicators	57
Research Population and Sampling Plan	59
Eligibility Criteria.....	59
Sample Size and Power	60
Sampling Plan.....	61
Protection of Human Subjects and Data Management	62
Data Sources	62
Validity and Reliability of Data	63
Analytical Methods.....	63
Evidence-Based Healthcare Services	64
Path Analysis and Statistical Models.....	65
Summary	66
CHAPTER FOUR: FINDINGS	67
Analysis of Demographic Characteristics	69
Descriptive Demographic Characteristics	70
Comparison between Study Sample and General Population	71
Analysis of Clinical Characteristics	72
Primary Clinical Diagnoses	72
Diagnoses Compared to National Case Volume	73
Major Diagnosis Categories and ICD9 Codes.....	74
Control Variables	75
Hospitalist and Case Management	75
Medicare and Medicaid as Payer	76
Geographical Service Area	77
Path Analysis and Statistical Modeling	77
Analytic Path Models of Inefficiency	79
Modeling Length of Stay	80
Analytic Path Model for Length of Stay	80

Modified Analytic Path Model for Length of Stay.....	81
Analysis of Length of Stay.....	82
Modeling the Cost of Services (Charges)	84
Analytic Path Model for Charges.....	85
Modified Analytic Path Model for Charges	86
Analysis of Charges	88
Modeling Discharge Delays	90
Analytic Path Model for Discharge Delays	91
Modified Path Model for Discharge Delay	92
Analysis of Discharge Delay	93
Analytic Path Models of Ineffectiveness	95
Modeling Readmissions.....	96
Analytic Path Model for Readmission.....	96
Modified Path Model for Readmissions.....	98
Analysis of Readmissions Model.....	99
Modeling Safety (Falls).....	101
Analytic Path Model for Safety	102
Modified Analytic Path Model for Safety.....	103
Analysis of Safety (Falls).....	104
Modeling Patient Satisfaction	106
Analytic Path Model for Satisfaction.....	107
Modification of Analytic Path Model for Satisfaction.....	108
Analysis of Satisfaction	109
Strategic Framework for Model Generating	111
Structural Models.....	111
Proposed Structural Model.....	111
Modified Structural Model	113
Final Analysis of the Structural Model	114
Hypotheses.....	116
Statistical Relationships, Unexpected Outcomes	119
Length of Stay	120
Cost of Care	120
Discharge Delays	120
Readmission Rates	121
Patient Falls	121
Patient Dissatisfaction	121
Summary	122
Discussion	124
Environment of Healthcare.....	124
Safe, Efficient, Effective Healthcare	125
National Framework for Quality.....	126
Hospital Measuring and Reporting	127
New Perspectives and Concepts	128
Implications.....	129
Findings Support National Framework	129

Innovation and New Delivery Models	130
Nurses Contribution to Quality and Value	131
Measurement Elements and Models.....	132
Limitations	133
Trust and Accountability for Hospital Data Sets	134
Conclusions	134
Theoretical Implications for Hospital and Clinical Structure	135
Theoretical Implications for Hospital Leadership and Research.....	137
APPENDIX A: VARIABLE DEFINITIONS WITH SPSS VALUE ASSIGNMENT.....	139
APPENDIX B: FREQUENCY OF DIGANOSIS RELATED GROUP ASSIGNMENT ...	141
APPENDIX C: NATIONAL QUALITY FORUM AND NURSE SENSITIVE CARE.....	144
APPENDIX D: NATIONAL DATABASE OF NURSING QUALITY INDICATORS.....	146
LIST OF REFERENCES	148

LIST OF FIGURES

Figure 1: Aged Population as a Share of Total U.S. Population	3
Figure 2: Medicare Hospital Insurance and Medicare Supplementary Spending	4
Figure 3: Conceptual Model of Successful Healthcare Transitions	7
Figure 4: Medicare Income and Costs Rates (Centers for Medicare & Medicaid, 2007). 9	
Figure 5: Predictors for Inefficient and Ineffective Healthcare Transition	21
Figure 6: Conceptual Structural Equation Model for Healthcare Transitions	78
Figure 7: Analytic Path Model for Length of Stay with GOF Measures.....	81
Figure 8: Modified Analytic Path Model for Length of Stay with GOF Measures	82
Figure 9: Analytic Path Model for Charges with GOF Measures	86
Figure 10: Modified Analytic Path Model for Charges with GOF Measures.....	88
Figure 11: Analytic Path Model for Discharge Delays with GOF Measures.....	91
Figure 12: Modified Analytic Path Model for Discharge Delays with GOF Measures	93
Figure 13: Analytic Path Model for Readmissions with GOF Measures	98
Figure 14: Modified Analytic Path Model for Readmissions with GOF Measures.....	99
Figure 15: Analytic Path Model for Safety (Falls) with GOF Measures.....	103
Figure 16: Modified Analytic Path Model for Safety (Falls) with GOF Measures	104
Figure 17: Analytic Path Model for Satisfaction with GOF Measures	108
Figure 18: Modified Analytic Path Model for Satisfaction with GOF Measures.....	109
Figure 19: Proposed Structural Model with GOF Measures	112
Figure 20: Modified Structural Model with GOF Measures	114
Figure 21: Final Structural Model with GOF Measures.....	115

LIST OF TABLES

Table 1: Theoretical Framework and Hospital Characteristics	32
Table 2: Variable Specification and Operational Definitions (Appendix A)	53
Table 3: Eligibility Criteria and Operational Definition.....	60
Table 4: Data Sources and Description.....	63
Table 5: Descriptive Statistics of Demographic Characteristics	70
Table 6: Demographic Characteristics Compared to State and National Population	71
Table 7: Comparison of Diagnosis Related Groups by Prevalence of Case Volume	74
Table 8: Frequency of Diagnosis by Major Diagnostic Category (MDC)	75
Table 9: Descriptive Statistics for Predictors of Inefficiency	79
Table 10: Parameter Estimates for Length of Stay.....	83
Table 11: Goodness of Fit Statistics for Length of Stay as a Predictor of Inefficiency...	84
Table 12: Parameter Estimates for Cost of Care (Charges).....	89
Table 13: Goodness of Fit Statistics for Charges as an Indicator of Inefficiency.....	90
Table 14: Parameter Estimates for Discharge Delays.....	94
Table 15: Goodness of Fit Statistics for Discharge Delay as Predictor of Inefficiency...	95
Table 16: Descriptive Statistics for Predictors of Latent Construct Ineffectiveness	96
Table 17: Parameter Estimates for Readmission	100
Table 18: Goodness of Fit Statistics for Readmission as an Indicator of Ineffectiveness	101
Table 19: Parameter Estimates for Safety (Falls).....	105
Table 20: Goodness of Fit Statistics for Safety (Falls) as Indicator of Ineffectiveness	106
Table 21: Parameter Estimates for Dissatisfaction.....	110
Table 22: Goodness of Fit Statistics for Dissatisfaction as Indicator of Ineffectiveness	110
Table 23: Parameter Estimates for Generated Structural Models	115
Table 24: Goodness of Fit Statistics for Generated Structural Models	116
Table 25: Summary of Hypotheses and Testing	118
Table 26: National Framework to Measure and Report Quality of Healthcare Services	127

LIST OF ACRONYMS/ABBREVIATIONS

AHRQ	Agency for Healthcare Research and Quality
ANA	American Nurses Association
CMI	Case Mix Index
CMS	Centers for Medicare and Medicaid
CR	Critical ratios
DRG	Diagnosis Related Group
GOF	Goodness of Fit
HQA	Hospital Quality Alliance
JCAHO	Joint Commission on the Accreditation of Hospitals
ICD9	International Code of Disease, version 9
IRB	Institutional Review Board
LOS	Length of stay
MDC	Major Diagnostic Categories
NDNQI	National Database of Nurse Quality Indicators
NQF	National Quality Forum
SE	Standard error
SEM	Structural equation modeling
SPC	Standardized path coefficients
TCF	Transitional care facility
UAP	Unlicensed Assistive Personnel
UPC	Unstandardized path coefficient

CHAPTER ONE: INTRODUCTION

Healthcare services for the aging population in the United States are a complex configuration of acute healthcare organizations, and post acute nursing facilities, home healthcare, and community based services. The system encompasses all services provided by an organization that imply the need for clinical, medical, or professional judgment (Baldrige National Quality Program, 2006). Most Americans believe the system exists to provide preventive services, management for chronic conditions, and health care services to meet the needs of the people (National Committee for Quality Assurance (NCQA), 2004).

The healthcare delivery system is fragmented across a broad array of settings (Coleman, Smith, Frank, Min, Parry, & Kramer, 2004), plagued by gaps in quality of care, and does not provide optimal care to the majority of American citizens (NCQA, 2004). As a result, national efforts are focused quality indicators, performance measures, and the driving need for quality of care improvements, innovative delivery models and consensus standards across a multiplicity of providers, payers, and stakeholders. The overarching focus of this effort is to bridge the gaps in health care quality, and improve disparities for vulnerable populations (NCQA, 2004).

Environment of Healthcare Services

The National Committee for Quality Assurance (2007) defines quality care as timely access to effective preventive services and medical treatment to guard and reinstate their health. However, each year thousands of people are admitted to hospitals, and an estimated 42,000-79,000 deaths occur because the healthcare

system fails to provide quality care (NCQA, 2004). The system has been described as a misnomer by the HMO Workgroup on Care Management (2004), and there is increasing concern being voiced by the American Hospital Association (2002) about the financial health of hospitals caused by social and economic forces. Few stakeholders believe the expenditures for healthcare services are providing good value, and most believe the system is unsustainable in the present state beyond the next decade (Houmann, 2007). The Baldrige National Quality Program (2006) suggests there is an overriding need within hospital organizations to provide progressive leadership and to answer the question, are hospitals making progress in their efforts to provide safe, value driven, quality care to the patients and the communities they serve?

Aging of the Population

The state of the healthcare system is especially troubling as the population begins to age and increases the demand for healthcare services. Driven by seventy-six million baby boomers born between 1946 and 1964, demographics in the U.S. are changing, and the numbers of people ≥ 65 are increasing (Mooney, Knox, & Schacht, 2002).

The U.S. Census Bureau counts everyone living within the United States and the territories of Puerto and the U.S islands every 10 years with the next census scheduled in 2010. The census is mandated by the Constitution and serves to determine Congressional representation and the need for national and community services (U.S. Census Bureau (2007). The Congressional Budget Office (2002) projects the aging

trend will extend beyond the baby boomers as life expectancy increases. Figure 1 provides a visual of projected aged population as a share of total population.

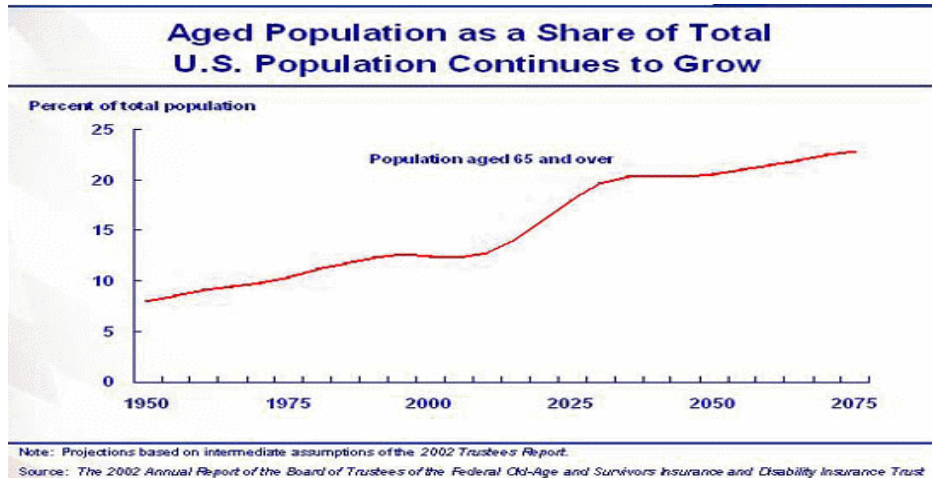

Figure 1: Aged Population as a Share of Total U.S. Population

Economics and Aging

The U.S. Census Bureau (2003) projects health care expenditures will mount significantly as the population ages. In 1996, an estimated \$294 billion was spent on healthcare for this age group and is projected to increase to \$867 billion by 2010. In comparison, long-term care costs were estimated at \$77.9 billion for 1996, and are projected to jump to \$310 billion by 2010 (Advisory Board, 2001).

The National Committee for Quality Assurance (2006) reports steady improvements in the Health Plan Employer Data and Information Set (HEDIS) measures for private health plans, but reports there have been limited improvements in the quality and value measures for Medicare beneficiaries. Medicare expenditures are projected to increase to 17 percent of the total Federal budget in 2008 (Congressional

Budget Office, 2002), and overall age related programs have been estimated in excess of 30 percent of the federal budget (Cohen, 1998). Medicare and private insurance are not expected to cover long-term care to any significant extent and a lagging number of older individuals have purchased insurance for this purpose. Medicaid long-term care expenditures for this group are projected to double by the year 2018 (Weiner & Stevenson, 1998). Figure 2 provides a visual view of the increase in Medicare spending over the last three decades.

Medicare spending

Spending on Medicare Hospital Insurance (HI) and Medicare Supplementary Medical Insurance (SMI) as a percentage of total federal outlays, fiscal years 1970-2004

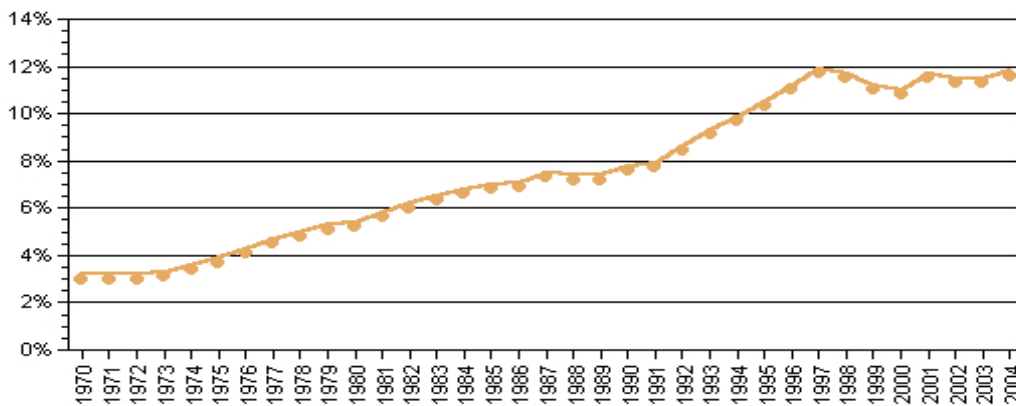

Source: Budget of the United States Government, fiscal year 2006

Figure 2: Medicare Hospital Insurance and Medicare Supplementary Spending

The 2002 Annual Report from the Board of Trustees, Federal Hospital Insurance and Federal Old Age and Survivors Insurance and Disability Insurance Trust indicates growth of the aging population slowed in 2000, but suggests the growth trend is projected to sharply increase as the next generation begins age.

Healthcare Transitions and Processes

The American Geriatric Society (2003) describes healthcare transitions as the processes, and set of actions put in place to ensure the continuity of care along the range and levels of services provided by the integrated system. The processes take place within the structure and organization of the healthcare system with the intent to ensure the integrity of a seamless continuum of care. The locations may be represented by units in acute care facilities such as hospitals, or post acute facilities such as skilled nursing facilities, rehabilitation units, patient homes, assisted living or nursing homes, primary or specialty care practices, and as a last resort, long term care facilities.

Fragmentation of Care

Persons such as the aging patient who are in need of continuous and often-complex care are very vulnerable to the fragmentation of care, and concerns for safety, and the overall quality of care are increasing as patients are transferred across different locations and systems (Coleman, 2003). Members of the HMO Workgroup on Care Management (2004) report that healthcare transitions are problematic as patients seek services across varying venues and conclude the problems pervade all aspects of care, often placing the patient at risk for complications and adverse events.

Generally, there is no structured process or single provider in place to assume responsibility for managing care across settings, and most often, patients and families assume the management of care (HMO Workgroup on Care Management, 2004). In this environment, plans for healthcare transitions may be poor (Coleman, 2000). As patients attempt to navigate the complexities of the system and families strive to bridge

the gaps in the continuum of care, patients are likely to “fall through the cracks” (Covinsky, 2003)

Healthcare transitions are very prevalent in the population aged 65 and older. In 2000, this group averaged more than...“400 ambulatory visits, 300 visits to the emergency department, 200 hospital admissions, 46 skilled nursing facility admissions, and 106 home care admissions per 1,000 persons”...(Coleman, 2003). While transitional care is widely practiced in communities, there is a paucity of attention given to the elements necessary for effective transitions, and Coleman (2003) concludes there is ample opportunity to improve transitional care models for this vulnerable population.

Donabedian Framework

For the purpose of this research a healthcare transition is defined as the transfer of a patient from one setting to another (HMO Workgroup on Care Management, 2004), and expanded to encompass the transition of the patient from the acute care setting to a Rapid Rehabilitation unit within a skilled nursing facility in the community. To better describe and understand the process of healthcare transitions and the need for quality measurement and indicators, the early work of Donabedian provides a foundation and a fundamental framework to organize the study constructs of inefficient and ineffective healthcare transitions. The paradigm developed by Donabedian is depicted as a triad, consisting of structure, process, and outcome, and his research on quality of healthcare services describes efficiency as the most health improvement at the lowest possible cost and effectiveness as the extent to which possible health improvements are achieved (Schiff & Rucker, 2001). Later research based on the Donabedian model

describes structure as the setting or system delivering care and the measures as those variables that relate either directly or indirectly to the organization or to the expertise of the providers (Birkmeyer, Dimick, & Birkmeyer, 2004). Figure 3 provides a conceptual model of successful healthcare transitions based on the triad of the Donabedian paradigm and serves to link the theoretical constructs of organization, leadership, and learning.

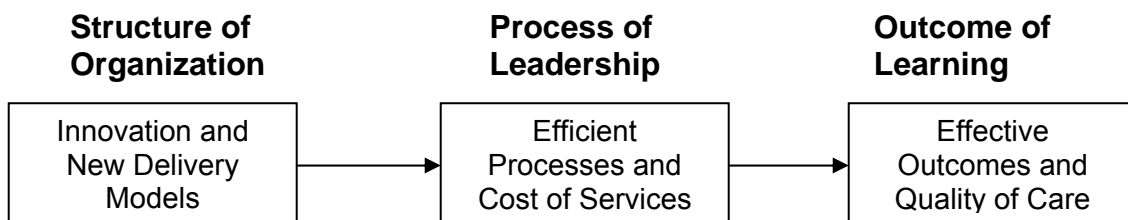

Figure 3: Conceptual Model of Successful Healthcare Transitions

Specification of Problem

Aging patients admitted to hospitals often fall through the cracks as they transition across multiple levels of care, providers, settings, and locations (Covinsky, 2003). Patients are most vulnerable during these transitions because organizational systems may fail to communicate the most essential information about the patient to the next setting, and team of providers. The results of a poorly executed transition can result in complications for the patient, frustration for families and care givers, increased length of stay, and readmission to the acute care setting (Coleman, 2003), result in functional decline for aging patients (Palmer, Counsell, & Landefeld, 2003), and has the potential to impact patient and family satisfaction.

Beyond the fractures in the healthcare system, and the resulting gaps in the continuum of care during transitions, this research is driven by four primary areas of concern (1) functional decline of the aging patient in the acute care setting (2) impact of the aging population on healthcare economics, (3) the quality and integrity of healthcare data available for research, and (4) the paucity of research dedicated to successful healthcare transitions. Collectively, these four problems require quality research dedicated to better understanding the predictors of successful transitions and innovative strategies such as Rapid Rehabilitation to improve healthcare services.

Functional Decline of Aging Patients

Many aging patients admitted to hospitals experience a functional decline in their physical ability to live independently. Known as dysfunctional syndrome, Palmer et al., (2003) report patients may experience a decline in their ability to manage activities of daily living, or instrumental activities of daily living, and may become depressed or physically impaired. Generally, the patient is admitted for an acute diagnosis, and the dysfunctional syndromes are not the focus of care. If no intervention takes place, the problems can impact the ability of a patient to return to independence, and cause increased length of stay in hospitals or nursing homes or *readmission* to the acute care settings. The end results can impact the prognosis and quality of life for the patient and family, and increase utilization of healthcare resources (Palmer et al.). Effective transitional delivery models, such as the Rapid Rehabilitation Model in this study, may support the early discharge of the patient from the acute care setting, decrease the potential for functional decline, and result in more efficient organizational performance.

Resources and Aging Population

The annual Medicare Trustees Report (2007) affirms earlier projections of escalating expenditures, and long term financial strains for healthcare services. In fact, the report triggers a funding warning from Medicare caused by an imbalance between tax incomes and expenditures as early as 2007 with exhaustion of Medicare in 2019. Figure 4 portrays the imbalance in the hospital insurance program or Medicare Part A and includes the projected deficits for the Social Security program.

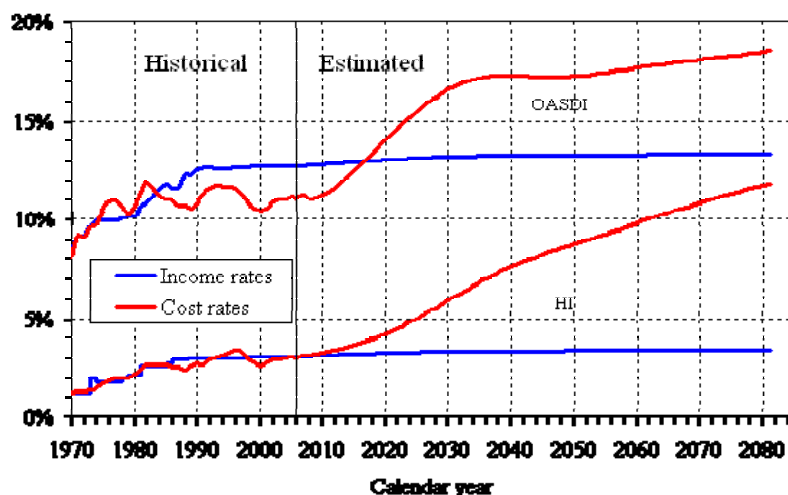

Figure 4: Medicare Income and Costs Rates (Centers for Medicare & Medicaid, 2007).

To protect the Medicare trust fund and to ensure the availability of services for future generations, the Center of Medicare & Medicaid administrators and trustees are evolving from a passive payer position to an active purchaser of quality, efficient, and effective healthcare. This means Medicare is mandating better information on the quality of care and cost of services (Medicare Trustees Report, 2007) and linking the

information to pay for performance initiatives and consensus of standards across all stakeholders (Straub, 2008).

While the government may be challenged to increase taxes and constrain services (Congressional Budget Office, 2002), healthcare systems are challenged to find innovative strategies to improve efficiency and to provide effective outcomes to improve length of stay rates, reduce readmissions, and reduce Medicare costs. Facing the future means innovative service models, creativity, stewardship of resources, and improving the healthcare experience for those we serve, our patients and our communities (Houmann, 2007). As the population ages and vulnerable patients seek services across settings operating as silos and encounter additional barriers created by regulations, and economic constraints, there is an increasing need to study healthcare transitions (Coleman et al., 2004) to better manage healthcare resources and to comply with federal and state quality of care and pay for performance initiatives.

Quality and Integrity of Data

There is increasing concern among researchers working with hospital generated data about the quality and integrity of health services information. The data has been called...”pivotal to the validity and reliability of inferences drawn from research”... (Pan, Fergusson, Schweitzer, and Hebert, 2005). Further, the data is critical to the integrity of patient care processes and the high performance work of the hospital to improve services to patients (Balridge National Quality Program, 2006).

Previous research studies designed to examine the quality of data as a component of performance and quality improvement, often yield confusing, and

conflicting results, leaving hospitals and scholars challenged to measure the effectiveness and efficiency of the organization, systems, programs, and processes (Bradley, Holmboe, Mattera, Roumanis, Radford, & Krumholz, 2004). The literature suggests availability of quality data to measure health services is a global challenge.

In 2001, quality healthcare became a political priority, and the Quality Initiative was established to create accountability and provide for public disclosure of health care information. Overall, the intent is to provide healthcare information to consumers and to encourage other stakeholders to improve quality of care. Although interest continues to expand, lack of standardization and priorities has hampered efforts to improve the safety and quality of healthcare services. Recently, regulations mandating the measurement and reporting of healthcare information has escalated. Collaborative efforts lead by a broad array of stakeholders known as the Hospital Quality Alliance, including the Centers for Medicare and Medicaid Services (CMS) and the National Quality Forum (NQF) are reaching a consensus on standards to ensure healthcare safety measures, and have endorsed greater than 200 standards (NQF, 2003). These standards are projected to be linked to the CMS pay for performance initiatives and private payers are expected to implement the same initiatives (Straub, 2008). These standardized measurements are calling attention to need for consensus on definitions, and measurement across all health care services and improves the opportunity to for researchers to better measure innovative delivery models and healthcare transfers.

Paucity of Transitions Research

Under the Medicare prospective payment system, the definition of transfer was expanded beyond acute care facilities, and now includes transfers between acute and post acute care providers for selected diagnoses, and the number of diagnoses included in the definition are increasing (Cromwell, Donoghue, & Gilman, 2002). The study by Cromwell et al. noted fundamental changes and increasing complexities of the healthcare market create the need for further research to clarify equitable financial responsibility when patients are transferred from acute to post acute care. While research and congressional mandates monitor financial responsibility for transfers, the literature suggests there is a paucity of research to address the management and quality of care as patients and families cross settings and services.

The inadequate availability of data to study the transition of patients across settings may be manifested as gaps in the continuum of care. Generally, practitioners do not follow patients across settings and as a result, patients and families are left to manage their care transitions without knowledge, and without the provision of leadership. Poorly implemented transitions threaten quality of care, patient safety, patient and family satisfaction, and may result in increased length of stays, barriers to discharge, readmission to acute care and adverse events for the (Coleman, 2003).

Strategic Interventions

The external health care environment has been described as hyperturbulent, meaning there is constant change in economic policy, and shifts in the options, and mechanisms available to finance healthcare services. As a result, stakeholders are

challenged to respond to rapid changes, and to develop strategies to address the efficient and effective operation of the organization (Rotarius & Liberman, 2000). This hyperturbulent environment compounds the complexities of care as patients attempt to traverse the system.

Bundling of Stakeholders

Driven by the uncertainty being experienced in the environment of care, Rotarius & Liberman, (2000) report that stakeholders from inpatient and outpatient delivery systems are bundling together to navigate the confusion in an effort to find some stability. The intent of this bundling of stakeholders is to collaborate on decisions critical to operation strategies that provide efficient and effective delivery of healthcare services with some predictability and benefits to the patients and to the community (Rotarius & Liberman, 2000). While stakeholders are bundling together to improve the healthcare environment, the HMO Workgroup on Care Management (2004) reports the management of care, and accountability for healthcare transitions remains limited.

National Quality Forum

Recently, the National Quality Forum (2007), funded by the Robert Wood Johnson Foundation, completed a 15 month study focused on nurse sensitive indicators. The purpose of the study was to better understand the impact of the nurse workforce on patient safety, quality of care, and environment of professional practice, and to identify challenges and barriers to successful implementation of the 15 NQF endorsed consensus standards attributed to nursing. The study provides nine

recommendations for linking nurse sensitive indicators to NQF endorsed consensus standards, and concludes the inclusion of nurse workforce data in performance and quality measures has value for decision making in the acute care hospitals (NQF, 2007).

National Database of Nursing Quality Indicators

Established by the American Nursing association in 1998, the National Database of Nursing Quality Indicators (NDNQI), 2007) is a repository of two data sets comprised of nurse sensitive quality indicators for patients, and nurse workforce data on work satisfaction, job enjoyment, and professional practice and environment. Membership in NDNQI has expanded to greater than 1200 hospitals across the U.S and membership continues to increase. At the national NDNQI conference in 2008, CMS announced a collaboration with NDNQI to link nurse sensitive indicators to value driven purchasing of health care services and pay for performance initiatives managed by CMS (Straub, 2008). The database resides and is managed by University of Kansas (NDNQI, 2007). The evolution of standardized measures and reporting methods provides for the opportunity to improve the quality and integrity of health services data for quality improvement.

Emergence of New Delivery Systems

The literature suggests there is an increasing need for quality research to ensure that valid and reliable information is utilized to draw inferences about performance of hospital systems (Selden & Sowa, 2004) and to provide a scientific foundation for the

management of healthcare services (Wan, 2002). As healthcare systems struggle to balance services and resources, Selden & Sowa suggest the interests in multi-dimensional models of performance are increasing in prominence as stakeholders, organizations and scholars strive to identify performance indicators to ensure that inferences drawn about health services are based on quality information

As a result of the shifting environment of care, and the demand for health services for the aging population, a number of new delivery systems are emerging. For simplicity in this research, the term integration is assumed to describe an environment of care that offers an extended range of services and provides for a seamless, cost effective continuum of care (Wan, Lin, Ma, 2002). An extended definition of integration was specified by Wan (1995), and includes the integration of structural, clinical, and information systems. This definition is further supported by the indicator criteria established for performance excellence by the Balridge National Quality Program (2006). Truly integrated delivery systems have been found to have a positive impact on the continuum of care and health care services (Wan, Lin, Ma, 2002). Research studies that establish and define indicators and take a multivariate statistical approach to the analysis of hospital system performance provide the potential to better understand the causal relationships in healthcare delivery services (Wan et al., 2002).

As hospitals seek new delivery models to provide more efficient and effective care across an integrated continuum of care, there is increasing interest in a variety of strategic interventions to safeguard and serve the aging population within the hospital environment. Among the variety of approaches, is the increasing utilization of hospitalists, hospital based physicians, to ensure safety, quality of care, and utilization

of resources for aging patients. Although this group already serves similar patients, mostly in critical care units, only a small number have been available as part of a strategic plan to optimize geriatric services. A number of studies highlight the possibility of this group to support innovative strategies and to improve the efficiency of care for this population (Advisory Board, 2006)

Rehabilitation for Aging Population

Rehabilitation for the aging population serves to manage and restore health at the physical, psychological, and psychosocial levels (American Geriatric Society, 1999). The American Geriatric Society believes access to rehabilitation may enable people to remain in their homes or in environments that provide for optimal independence, and result in reduced expenditures for healthcare services. Their position statement suggests an interdisciplinary approach to rehabilitation, education for providers, increased funding, and ongoing research and evaluation of rehabilitation models. While rehabilitation is viewed as beneficial in the literature, the American Geriatric Society reports there are limited research studies to evaluate the effectiveness and efficiency of the range of delivery models.

This research expands the definition of Rapid Rehabilitation to mean a trans-disciplinary, collaborative process that seeks to optimize discharge from the acute care setting for qualified patients and to improve the efficient utilization of healthcare resources. Therapies and rehabilitation techniques are available to serve a variety of physical, psychological, and psychosocial rehabilitation needs. The program is a collaboration of hospital leadership, clinical, financial, and information services, and

supported by the learning environment within the hospital environment. The program is operating within a sophisticated medical system, and challenged by the complexities of public affairs and socioeconomic forces.

Purpose of Research

This research addresses the state of healthcare services for the aging population and the efforts of a large acute healthcare system to provide efficient, effective, and innovative healthcare services for aging patients as they transition across a multiplicity of settings, and a complex array of services, providers, and payers.

The overriding intent of research on healthcare transitions is to better understand the management of transfers across settings for the aging population and to support the ability of the hospital to return patients to independence in the community or to the highest level of independent functioning through successful transitions across settings and systems.

More definitively, this research seeks to examine the process of transition to Rapid Rehabilitation by establishing indicators to measure quality of care defined as two constructs, efficiency of processes and effectiveness of outcomes. Further, this research provides a theoretical and analytical framework to examine predictors and strategies to improve the healthcare transition process for patients age ≥ 65 admitted to the rapid rehabilitation in a large Central Florida hospital system. Finally, the study aims to describe the value added potential for research to integrate data from clinical, financial, organizational, and information systems to establish benchmarks for the

transition process and to ensure that inferences drawn about healthcare transitions are based on valid and reliable evidence

Description of Research Setting

The hospital providing the setting for this research has experienced a >20 percent increase in the admissions of patients ≥ 65 years of age during a three year period with nearly 40% of the total admissions in this age group. At the organizational level, the result is increased Medicare costs, increasing length of stays, and mounting readmissions to the acute setting. The hospital system is at capacity and the need for successful transitions to outpatient services and facilities is projected to increase. The hospital organization is seeking to learn more about healthcare transitions through research and the development of new, innovative models, such as the Rapid Rehabilitation Model to deliver quality healthcare services.

In April of 2005, the hospital system established a Rapid Rehabilitation program within an outpatient facility owned by the hospital system for the purpose of bridging the gaps in health services for the aging population and to optimize the options for early discharge from the acute care setting. However, the value of Rapid Rehabilitation for the aging population is unknown and this research seeks to explore and establish predictors to measure the impact of the Rapid Rehabilitation program on the efficiency of processes and effectiveness of outcomes as healthcare services are delivered to the aging population as they transition across services and settings within the healthcare system.

The program serves to enable qualified patients age ≥ 65 to receive rapid rehabilitation for physical or cognitive needs in the outpatient setting. During the first year of operation, the Rapid Rehabilitation unit had a capacity of 37 beds, and was in operation for 9 months. Greater than 100 patients were admitted from the multi-hospital system in the initial study year of 2005.

Rapid Rehabilitation as Intervention

The benefits of Rapid Rehabilitation are believed to provide more options for patients and families, decreased barriers to discharge, decreased adverse events during hospitalization, avoidance of admission to nursing facilities or long-term care, decreased readmissions, and more efficient and effective utilization of healthcare and community resources.

To overcome potential gaps in care management between the acute care hospital and post acute rapid rehabilitation unit, information systems are integrated across the hospital system and the transitional care facility. This serves to bridge the information gap between settings, improve communication between providers, and ensure continuity of care for the patients and families. A physician is dedicated to care management in the skilled nursing facility. Patient centered care is provided by a nurse practitioner and professionals educated in elder care management and rehabilitation. Patients are referred to rapid rehabilitation through primary care physicians and the hospitalist program. As demand for services increase, there is a mounting necessity for research to establish performance indicators for the program, and to identify any

barriers to successful transitional care as administrators and medical staff consider the expansion of the program to other facilities and geographical locations.

Specification of Study Variables

The literature review, exemplified by Selden & Sowa (2004), suggest there is not a best measure for organizational performance, but suggest that researchers should continue to evaluate the potential for multi-dimensional models. This study follows the recommendations of previous research in the literature on organizational performance measures by approaching transitional care as a micro-system within a complex hospital system. The Baldrige National Quality Program (2006) serves as a reference and resource for the identification, definitions, and quantification of study indicants.

Research from two randomized trials of a similar model, Acute Care for the Elderly (ACE), carried out at the University Hospitals of Cleveland and the Akron City Hospital, provides further guidance for the selection of variables. Evidence from the ACE projects demonstrated improved health status measured at the patient level, but concluded that further research is necessary to document the performance of transitional delivery models measured at the organizational level (Palmer et al., 2003).

Among the other recommendations in the literature is the need to address readmission rates, and continuity of care (Hong, Morrow-Howell, & Proctor, 2004), and the need to establish criteria for performance excellence (Baldrige National Quality Program, 2006). The current study variables are depicted in Figure 5.

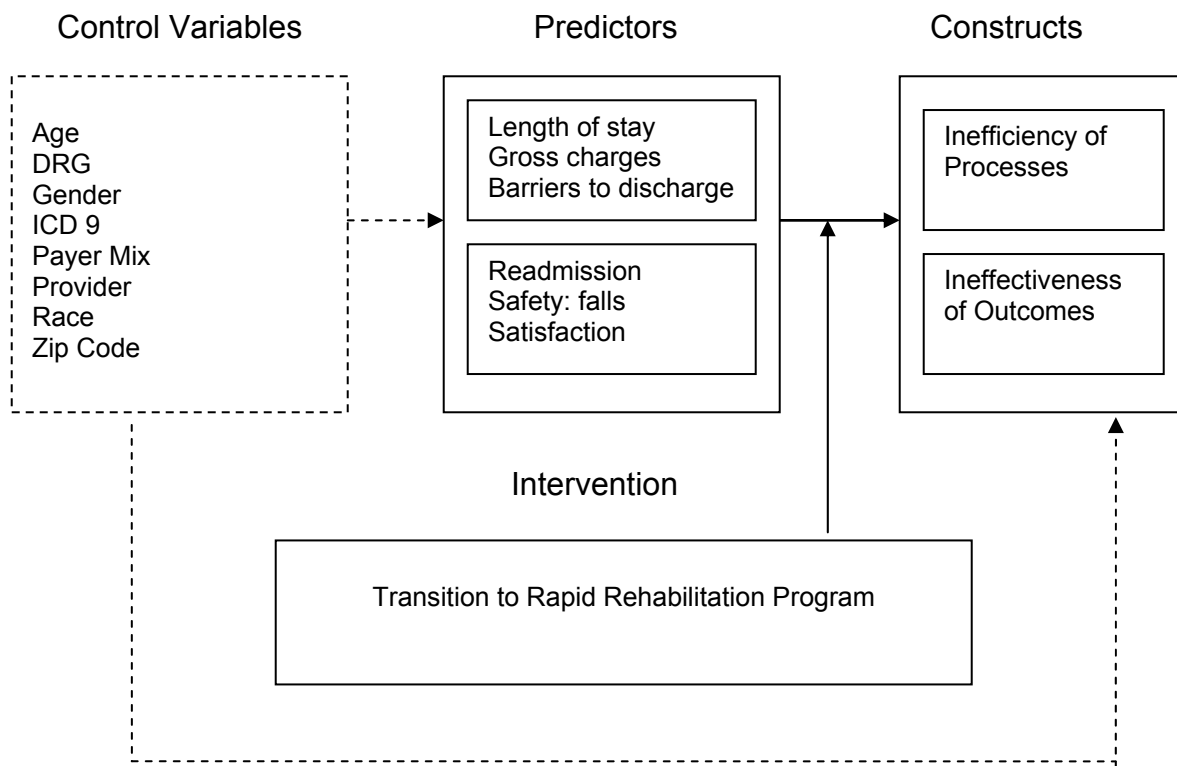

Figure 5: Predictors for Inefficient and Ineffective Healthcare Transition

While this research strives to provide a framework to analyze the impact of rapid rehabilitation on the healthcare transition processes and outcomes, there are complex social and political forces driving the challenges faced by health care service organizations. These causal relationships must be taken into consideration in the final selection of the analytical model and as the indicator variables are better understood and correlated. According to Wan (1995), the causal relationships are likely to create situational threats to internal and external validity. Finally, the quality and integrity of the available hospital data are pivotal to the inferences that may be drawn in the study

(Pan, Fergusson, Schweitzer, & Hebert, 2005), but are not under the control of the researcher (Mauch & Park, 2003).

Questions and Hypotheses

The question of how to best evaluate the performance of organizations has vexed scholars for decades, and the literature is littered with confusing, and often conflicting analytical models on the topic (Selden & Sowa, 2004). Definitions for the terms used in the study questions and hypotheses are obtained from the Balridge National Quality Program (2006), which is structured under the U.S. Department of Commerce, and managed, by the National Institute of Standards and Technology (NIST). Among other responsibilities, NIST supports hospital organizations to obtain tools and access information to improve their ability to compete in the global marketplace (Balridge National Quality Program, 2006).

Definition of Constructs

The term *efficient* relates to processes and the systematic effort to provide an increasingly higher level of health services for the patient and the overall improvement of organizational processes. For this research that means decreasing the length of stay, decreasing gross expenditures, and eliminating any barriers to a successful transition from the acute care setting to the post acute care setting in the community (Balridge National Quality Program, 2006).

The term *effective* is utilized to mean the outcomes associated with how well rapid rehabilitation meets the intended purpose to improve the transition of patients from

the acute care to the post acute care setting. Measuring effectiveness includes the theoretical alignment with the hospitals leadership system that has high expectations for the improvement of performance, and the need to increase the availability of beds, decrease readmission rates, provide for a safe environment of care, and improve patient satisfaction with services (Balridge National Quality Program, 2006).

Questions to be Investigated

The purpose of this research is to examine indicators of efficient and effective healthcare transitions an acute care hospital to the community for rapid rehabilitation:

1. Holding constant the patient and facility characteristics, does transition to rapid rehabilitation have an inverse relationship with indicators of inefficient healthcare processes when delivering healthcare services to the aging patient?
2. Holding constant the patient and facility characteristics, does transition to rapid rehabilitation have an inverse relationship with indicators of ineffective healthcare transitions when delivering healthcare services to the aging patient?
3. Holding constant the patient and facility characteristics, does transition to rapid rehabilitation have an inverse relationship with indicators of efficient and effective healthcare transitions when delivering healthcare services to the aging patient?

Hypotheses

H1: Holding constant the patient and facility characteristics, transition to rapid rehabilitation has an inverse relationship with the predictors of inefficient healthcare transitions when delivering healthcare services to the aging patient.

1a: Holding constant the patient and facility characteristics, transition to rapid rehabilitation has an inverse relationship to length of stay.

1b: Holding constant the patient and facility characteristics, transition to rapid rehabilitation has an inverse relationship to hospital charges.

1c: Holding constant the patient and facility characteristics, transition to rapid rehabilitation has an inverse relationship to discharge delays.

H2: Holding constant the patient and facility characteristics, transition to rapid rehabilitation has an inverse relationship with ineffective healthcare transitions when delivering healthcare services to the aging patient.

2a: Holding constant the patient and facility characteristics, transition to rapid rehabilitation has an inverse relationship to readmissions.

2b: Holding constant the patient and facility characteristics, transition to rapid rehabilitation has an inverse relationship with patient falls.

2c: Holding constant the patient and facility characteristics, transition to rapid rehabilitation has an inverse relationship with patient dissatisfaction.

Ha 3: Holding constant the patient and facility characteristics, transition to rapid rehabilitation has an inverse relationship with the predictors for inefficient and ineffective healthcare transitions when delivering healthcare services to the aging patient.

Summary and Significance of Study

Chapter one provides the historical background to better understand healthcare transitions, and reports on the problematic issues within the healthcare system and the literature. The chapter introduces *rapid rehabilitation* as an intervention and provides an

overview of the need for research to analyze healthcare transitions to ensure the availability of valid and reliable data to draw inferences about the processes and outcomes of emerging delivery models represented Rapid Rehabilitation in this research. Finally, the chapter proposes terms, definitions, research questions, hypotheses, and recommends a multivariate approach to study the influence of rapid rehabilitation on healthcare transitions to ensure effective and efficient healthcare services for the aging population.

While this research strives to establish a conceptual and analytical framework to evaluate a *rapid rehabilitation* delivery model to improve healthcare transitions, there are complex organizational, social and political forces driving the challenge of hospitals to balance services and resources (Selden & Sowa, 2004) and further challenges to obtain quality data to measure the processes and outcomes of healthcare transitions (HMO Workgroup on Care Management, 2004). The causal relationships between acute and post acute systems providing healthcare services are very complex and the theoretical framework and literature review in chapter two are intended to describe and link these complex issues to the challenges imbedded in healthcare transitions.

This research supports and is significant to quality of care, safety, and pay for performance initiatives at all levels of healthcare services. New delivery models like the rapid rehabilitation model in this research provide a significant opportunity to bridge gaps in care management and accountability when patients transition from acute care in the hospital to services in the home or community. This research will be of interest to hospital administrators, nursing administrators, case managers, providers, researchers dedicated to aging research, and patients, families who are falling through the cracks.

CHAPTER TWO: THEORETICAL FRAMEWORK AND LITERATURE REVIEW

Health services for the aging population are a complex public affairs concern that crosses all social boundaries and professional disciplines. As a result, the theoretical framework must bridge organizations, systems, and human resources. The objective of this chapter is to identify those frameworks most beneficial to the broadest range of stakeholders as they strive to serve this population within health care organizations.

The Baldrige National Quality Program (2006) recognizes and awards organizations who meet their criteria for performance excellence. Their program is based on seven categories of core concepts and values: (1) leadership, (2) strategic planning, (3) focus on patients, other customers, and markets, (4) measurements, analysis and knowledge, (5) human resource focus, (6) process management, and (7) results. The program believes that an effective leadership system establishes the standards for performance and improvement efforts within the organization and incorporates learning throughout the operations of the organization (Baldrige National Quality Program, 2006). The theoretical framework for this research is based on the measures in the Baldrige National Quality Program.

Theoretical Framework

For decades, scholars have strived and been perplexed to respond to questions concerning the measurement of organizational efficiency and effectiveness. The topic has generated a plethora of research, theories and models, but at this time, there is no agreement in the literature to define best indicators (Selden & Sowa, 2004). Driven by the increasing complexities of the health care marketplace, delivery system challenges,

and advances in information systems, Selden & Sowa (2004) believe there is renewed interest in establishing health care performance indicators and knowledge databases to support the management, and performance of health care organizations. The Balridge National Quality Program (2006) provides increasing evidence that organizational, and systems management, leadership, and ongoing learning are attributes that contribute to efficient and effective care within health care organizations, and the marketplace.

The healthcare transition model utilized in this research, delivers care across diverse delivery systems, and patients receive care from a multi-disciplinary array of providers. While there is no one theory for transitional care, there is a plethora of theories to support health care from the perspective of the organizations that are providing the services. Drawing on the literature, and guided by the work of the Balridge National Quality Program (2006), three theories are selected and presented to support this research.

Organizational Theory

Organizational theory has evolved over the decades to encompass a broad range of academic thought about how organizations and systems function, but has been largely ignored by the health care industry and health services (Best, et al, 2003). Building on classic organizational theory, contemporary theorists have attempted to unify and explain organizations as open systems and believe that the objective of theory is to explain cycles of growth and decline, to predict efficiency and effectiveness, and to introduce purposeful changes which may support the organization to be more responsive to human needs (Shafritz & Ott, 1996). Hospital organizations are made-up

of multiple systems and processes, and services may be intertwined or independent of each other and include growth, stability, and interaction. Organizations, much like society, are defined as people, formal structure, informal structure, status and role concepts, and the physical setting (Shafritz & Ott, 1996) all working together for a collective purpose.

The study by Selden & Sowa (2004) reviewed organizational theories, and found the knowledge bases associated with the multiplicity of theories to be unclear and often confusing. However, their work encompasses a broad overview of organizational theory as a foundation to address the challenges and possibilities of developing a model to measure organizational performance. They recommend that research on organizational performance should include both objective and perceptual measures because the indicators may yield very different outcomes. Further, they suggest by sampling multiple indicators, knowledge bases may be developed that allows scholars, and researchers to accumulate evidence that cross the boundaries of policy, and programs, and contributes to the development of a multi-dimensional framework in a single construct. The continuing work of Best, et al, (2003), and Selden & Sowa (2004), and others supports the innovative utilization of organizational theories to establish clear parameters for performance measurement within organizations.

Theory of Servant Leadership

In the most traditional sense, a leader may conjure up images of a champion operating in an environment that is autocratic or hierarchical, or perhaps a visionary that is charismatic and leads through persuasion. The concept of the servant leader

developed by Robert Greenleaf, dispels those images, and describes a leader that enables others to develop the capabilities of leadership through open communication, interaction, and expectations to reach maximum performance (Smolenyak & Majumdar, 1992). Greenleaf built the theory based on the belief that ...”everything begins with the... thoughts, attitudes, and actions of the individual”...Greenleaf, 2002). Research by Swearingen (2004) found a positive correlation between nursing leadership characteristics and nurses satisfaction with their jobs, and the ability of the organization to retain the nurse workforce. The Theory of Servant Leadership calls for foresight, awareness, communication, and the ability to serve, and includes the ability to incite others to develop skills to become leaders (Spears, 2003).

In 2004, the Agency for Healthcare Research and Quality (AHRQ), the Centers for Medicare and Medicaid Services (CMS), the National Cancer Institute (NCI) and Health Affairs brought together a group of health care leaders and experts to examine health delivery systems. The objectives included the establishment of collaborative partnerships, innovative systems, identification of financial and non-financial incentives, as well as a discussion of the public policy changes necessary for the transformation of the nation’s health system through leadership and learning. Through leadership and a willingness to explore and learn, the participating organizations demonstrate the great potential to utilize innovative delivery systems, and new information technology (IT), to provide patient centered care that is effective, efficient, and sensitive to culture and ethnicity (Arnold, 2004).

Participants at the conference shared examples of effective delivery system transformations. Johns Hopkins University Hospital provides evidence of how systems

theory, leadership, and information work together to improve quality of care. Through leadership, education, and quantified evaluations, they improved patient safety in the intensive care units. One of the unexpected and positive outcomes of their efforts was the empowerment and retention of the nurse workforce (Arnold, 2004).

Theory of the Learning Organization

Early pioneers in the theory of organizational learning, Argyris and Schon (1996), developed the single loop/double loop model for learning. They determined that learning within organizations occurs under two circumstances, (1) the organization achieves the intended outcome or (2) there is a disparity between the intentions and the outcomes suggesting that learning was not achieved. Building on the work of these early researchers, Peter Senge describes the learning organization as an environment that supports and nurtures people to pursue their capacity to produce new ideas, to think critically, and to collectively work together for the whole of the organization (Smith, 2001). The definition is built on the premise that in turbulent, rapid changing environments, such as health care, organizations must be responsive to rapid change. To survive or excel in the marketplace, and for change to take place, the organization must be able to depend on the knowledge and skills of the people and the organization, (Smith, 2001).

At the 2004 conference of the Agency for Healthcare Research and Quality (AHRQ), the Centers for Medicare and Medicaid Services (CMS), the National Cancer Institute (NCI) and Health Affairs, participating organizations were invited to present innovative examples of transformed delivery systems that had improved quality, safety,

and efficiency for their organizations. Denver Health noted that large systems are composed of smaller systems and utilized micro-system changes to transform and balance a new organizational culture through employee engagement and leadership (Arnold, 2004). A study by Joseph (2007) finds that innovativeness in nursing is supported when five conditions are present within a learning environment, hospital's mission, organizational identification, organizational support, relational leadership, and workplace relationships. In addition Joseph (2007) found these antecedents provide for a climate that encourages the social process of trust, inquiry, idea generation, support, trialing, and learning. The most innovative of organizations in the literature demonstrate the core principles described by the Theory of the Learning Organization.

Theoretical Framework and Study Hospital

Transformation of healthcare delivery systems through research and development of new models of care to serve the aging population requires organizational integration, a leadership system, and learning at all levels of the organization. In addition to classic organizational theory, Robert Greenleaf's Theory of Servant Leadership and Peter Senge's Theory of the Learning Organization provide new vistas for the study of health care systems and were selected as the theoretical framework for the development of this research. These theories are embodied by the hospital providing the setting for this research and are evident in the high performance standards set by the extent and provision of education provided to the hospital staff. As an example, the hospital has implemented a geriatric education program and trained nearly 400 nurses and certified nursing assistants as resources for the aging patients

seeking services within the system. The geriatric education curriculum has been integrated throughout the system and has resulted in improved safety for the aging population as evidenced by a 28% reduction in falls. The hospital extended the learning opportunity to 53 nursing homes with a three county geographical proximity to the hospital. The theoretical framework is evident in the research and development provided by the study hospital to establish the Rapid Rehabilitation Program as an intervention to optimize the healthcare transition of aging patients from the acute care setting to the post acute setting in the community.

Table 1: Theoretical Framework and Hospital Characteristics

Theory	Theory Elements	Hospital Characteristics
Classic Organizational Theory	Structure, processes, outcomes	Innovation, process improvement, new delivery systems
Theory of Servant Leadership	Leadership	Leadership development program at all levels
Theory of Learning Organization	Learning	Education curriculum at all levels, education specific to patient centered care and aging population

Literature Review

Healthcare services for the aging population are a complex public affairs concern and the complexities are exacerbated by the rapidly changing external environment. The literature review begins with an overview of the social and market forces and the challenges and risks faced by patients and families as they attempt to navigate the healthcare system and transfer between settings, providers, and payers.

Health and Public Affairs

Major legislative initiatives are under consideration at the national level to address the problems of inefficient services, ineffective outcomes, escalating risks, and dwindling resources. Strategies to integrate Medicare and Medicaid are being piloted, and regulatory agencies are calling for managed care and integration of delivery systems (Arnold, 2005). Miller & Weissert (2003) reports the overlap between the Medicare and Medicaid programs increases the complexities of integration, provides opportunities to shift the burden and costs of care, and conclude the incentives structured within the posited designs leave room for improvement. Miller & Weissert (2003) recommend accountability and consideration for incentives in future delivery system designs.

The implications for public affairs are clear, and cross all healthcare disciplines. There are social barriers to overcome that will require the work of all stakeholders and researchers. As an example, there is a social phenomena that Washington calls, the "woodwork effect", meaning there is the concern that many elders will demand services in their homes for long-term care, if a financing system is made available. Knickman & Snell (2002) believe the primary social challenge within the woodwork effect is agreement on how to best allocate dwindling resources as elder programs compete with a variety of social priorities (Knickman & Snell, 2002).

Nationally, there is a growing interest in an age-integrated society, which takes advantage of the broad range of experiences of elders. The process can serve to bring elders into the mainstream and relieve some families of the burden of care. Integration of the generations within communities may also provide some support for the elders, as

most prefer a mixed age neighborhood (Knickman & Snell, 2002). In turn, managing the quality and integrity of healthcare services for the aging population improves the opportunity for effective, efficient health services, and enable elders to remain independent in the community.

Hospitals as Organizations

Over the last two decades, hospital organizations have restructured and downsized their formal structure and personnel including the nursing staff. In addition, inpatient beds have been reduced, and services eliminated (Unruh & Byers, 2002), and shifted to outpatient settings and community based care models (Kimball & O'Neil, 2002). Managed Care introduced capitated financing which placed limits on health care resources and held providers accountable for the use of those resources (Kimball & O'Neil), 2002. However, new demand for hospital services is requiring new capability even as hospitals are challenged to access funding necessary for capital improvements like replacing aging facilities and expensive technology systems (AHA, 2002).

The parts of a hospital must function together to provide services to citizens, but hospital operations are challenged by a multitude of social and political concerns. For example, the current nursing shortage is qualitatively and quantitatively different than previous cycles of supply and demand, and is seen as an opportunity for a comprehensive discussion about how the profession relates to the healthcare system (Kimball & O'Neill, 2002). Havens and Aiken (1999) found the organization of nurses' work within the hospital organization to be a major determinant of patient and staff

welfare. The attributes of the organization enable nurses to provide high quality care and promote desired patient outcomes.

In addition to structural reorganization, hospitals have implemented other widespread innovations to redesign work organization, roles, processes, and practices to conserve resources. Most initiatives also include the flattening of management layers, altering the structure of the delivery team, cross training personnel, decentralizing services, reconfiguring the physical environment, and augmenting information technology to enhance patient care (Havens & Aiken, 1999). While all organizations experience change, the cycles are predictable, and require business strategies that include the recognition and management of human resources (Fottler, Hernandez, & Joiner, 1994).

Market Forces

Hospital organizations are bearing the cumulative impact of multiple social and financial forces that threaten the bottom line and there is growing concern hospitals will be unable to support their top priority, providing quality care to patients, families, and the communities. The American Hospital Association (AHA) refers to these forces as “cracks in the foundation of care” and suggests the situation could worsen without positive congressional and administrative action (AHA, 2002).

The financial forces impacting hospital organizations are significant and may be summarized in eight broad categories as reported by the AHA (2002): (1) workforce shortages, which in 2002 cost Florida hospitals \$158.8 million to fill the positions, (2) readiness to respond to nuclear, biological, and chemical emergencies is projected to

be greater than \$11 billion, (3) regulatory mandates, such as compliance with the Health Insurance Portability and Accountability Act (HIPAA) is estimated to cost \$4-\$22 billion, (4) technology and cutting edge scientific development, for example, the purchase of CAT scan machines to replace x-ray machines at a cost of \$1 million per unit and PET imaging machines at \$2 million, (5) the cost of pharmaceuticals and blood products is increasing 31 percent in 2001, and some states have reported increases as high as 100 percent , (6) professional liability insurance for hospitals and physicians is a rapidly developing crisis with rates increased greater than 30 percent, (7) providing uncompensated healthcare exceeded \$21.6 billion in 2000, and finally (8) federal reimbursements under the Medicare and Medicaid programs in 2000 paid hospitals one percent less than the actual cost of treating (AHA, 2002).

These financial forces compel concern for the financial viability of our nation's hospitals as 58 percent of them report to be losing money in treating Medicare patients, 34 percent lose money providing inpatient services to Medicare patients, and 32 percent, one in three, report negative operating margins (AHA, 2002). Collectively, the AHA report suggests that hospitals face significant financial challenges, and must find innovative models of care to control costs. In this research, innovation is exemplified by the Rapid Rehabilitation model established by the study hospital to ensure effective health services and efficient utilization of dwindling resources as the population ages.

As early as 1998, long-term care was known to exist as a significant financial risk to citizens, families, and government at all levels (Cohen, 1998). For some states, long-term care represents the fastest growing item in their budgets; and for the Federal Government, Medicare home care represents the fastest growing component of the

budget (Cohen, 1998). As financing responsibility for long term care services for the aging population shifts from Federal responsibility to states, individuals and families, governments are exploring options for controlling the costs associated with long-term care. Likewise hospital organizations and providers have a new interest in responding to market competition, shifts in consumer preferences, and changes in reimbursement and financing policies (Cohen, 1998).

Competition for Resources

While the need for health services and long-term care increases with age, there are almost an equal number of *non-elderly* under the age of sixty-five who require long-term care. Feder et al. (2000) studied long-term care in the United States and documented this population at an estimated 5.6 million people, four million of them children. About 2.5 million reside in nursing homes. Of those living in the community, more than 25 percent are severely impaired and require assistance with more than three activities of daily living. When compared to the general population, persons who need long-term care are disproportionately low income, old, and living alone or with relatives. In addition to the costs of long-term care, they incur a substantial portion of acute care services (Feder et al, 2000).

In a report from the Florida Hospital Association (2003), hospitals are seeing dramatic increases in costs associated with providing care to uninsured (self-pay), and non-U.S. citizens. In 2002, there were 705 cases with hospital costs of \$40.2 million with the average costs for non-obstetrical care averaging \$63,155 per patient. In these circumstances, hospitals may expend substantial resources to transition the patient

back to their home country or identify long-term care in the community. Resources to support this population are limited and generally, leaving hospitals to absorb the costs. Already challenged by decreasing Medicare and Medicaid reimbursements and soaring medical liability premiums, the study reports the healthcare system can not sustain this burden of care (AHA, 2003).

Healthcare Services in State

In the state of Florida, there are political mandates and extensive plans to redesign the elder care service systems. The Agency for Health Care Administration, the Department of Elder Affairs, and community partners are leading efforts to identify delivery system alternatives. The Agency for Health Care Administration (2004) reports the objective of the collaboration is to divert admissions from acute care organizations, return patients to their optimal level of function, and to support those in need of outpatient services to remain independent in their homes through integrated, transitional, and alternative delivery systems. The Florida Department of Elder Affairs (2006) reports the 2006 legislative session passed >50 bills relative to health and community services for the aging population.

In Florida, the demand for elder care services is growing rapidly. Florida is ranked first in the nation for the population ≥ 65 and this population is projected to increase by 130% over the next twenty years (U.S. Census Bureau, 2003). In the study of a large Central Florida hospital system, aging patients ≥ 75 were the most frequent visitors to the hospital emergency department (Rotarius, et al, 2002). During fiscal year 2002-2003, overall expenditures for long-term care encompassed 28% of total Medicaid

expenditures and exceeded three billion dollars. A congressional presentation by the Agency for Health Care Administration in 2005 recommends an integrated care management model to meet the increasing needs for services to the aging population on Medicaid, and calls for the services to be provided in settings that are the least restrictive for the patient (Arnold, 2005).

Patient Centered Care Management

Driven by changing demographics and economic trends, there are growing concerns elderly persons may be at risk for financial catastrophe and inadequate care (Feder et al., 2000) as families become unable to sustain the burden of care and responsibility shifts to public, and/or private programs (Agency for Health Care Administration, 2004). This trend is particularly troublesome for the long-term care system because the largest growth in the over 65 population will be the oldest-old with higher disability rates (Knickman & Snell, 2002) causing further strain for families and the delivery systems.

Although informal care contributes to the overall funding of long-term care, there are growing concerns about the impact of informal elder care on the workplace and the costs to employers. In a study by the Winter Park Health Foundation (2000) on elder care and the workplace, seven national trends emerged in the surveys: (1) increasing number and longevity of older workers, (2) increasing number of employed workers caring for older relatives, (3) impact on work of absenteeism, tardiness, stress, and leaves of absence, (4) increasing demands on supervisors to counsel employed caregivers and manage the effects on work, (5) desire of older workers and caregivers

for flexible work options, (6) cost of providing and administering elder care work/life benefits, (7) low usage of elder care benefits due to a non-supportive company culture.

In a recent study sponsored by the Robert Wood Johnson Foundation, organized case management processes (CMP), which supports the transition of patients within health care delivery systems, were found to improve quality of care. However, the study recommended new incentives, information technology, and organized processes to facilitate use by providers (Lawrence, et al., 2003).

Reliance on Formal Care

There is growing concern by the American Hospital Association, that the aging population will have significant impact on hospitals as demands for care increase in an environment experiencing dwindling resources (AHA, 2007). Over the last ten years, the population aged 65 and older has increased 21 percent causing a corresponding increase in expenditures on age related programs. The Advisory Board (2001) reports the number of elderly requiring long-term care in the community will increase from seven to fourteen million by the year 2020.

In addition, an increasing life expectancy means the oldest of the elderly will be the fastest growing age group with a fivefold increase projected in the coming decades. This aging population is projected to have substantial increases in disabilities, physician visits, and hospital admissions. The demand for long-term care services and the resulting costs are projected to exert increasing demands (Advisory Board, 2001) on a hospital system that has restructured, downsized, reduced in-patient beds, and systematically eliminated services since the early nineties (Unruh & Byers, 2002).

A study by Spillman and Pezzin (2000) used the 1984 and 1994 National Long-term Care Surveys as sources to examine changes over a decade in the sources of care for disabled adults. Although the results showed a decline in the total number of active caregivers, there are a constant number of primary caregivers looking after recipients who were more severely disabled. Members of the sandwich generation and full-time workers increased as primary caregivers. Their conclusions suggest competing demands confronting the caregivers and increased disability levels among the recipients may have contributed to the growing pattern of reliance on formal care (Spillman & Pezzin, 2000).

Transforming Healthcare Delivery System

Investing in healthy aging may lower disability rates (Knickman & Snell, 2002), and integrating elder care services across the continuum of care may result in more efficient care and effective outcomes (Havens & Aiken, 1999). Finally, transformation of the delivery system through a transitional care model with qualified human resources, and business strategies, contributes to the support of livable communities with consideration for elder citizens and a reduction of the impact of an aging population on acute and post acute healthcare resources (Knickman & Snell, 2002).

Demonstration Projects

There are projects underway across the country, which demonstrate promising practices in health services that support the transition of aging patients across delivery systems. The Centers for Medicare and Medicaid Services have implemented 15

Coordinated Care Demonstration projects to study care management and disease management in the Medicare population, none of the 15 projects examines the elements of health care transitions. Research by Weissert, Hirth, Chernew, Diqan, & Kim (2003) suggest that providing case managers with value added information on patients may decrease risks, increase benefits and result in improved medical and financial outcomes. Coleman (2003), the HMO Workgroup on Care Management (2004), Selden & Sowa, (2004) concludes there is an opportunity to provide higher performance of healthcare services through the contribution of high quality research and to bridge the gaps in healthcare services during healthcare transitions.

The University of Massachusetts Medical School Center for Health Policy and Research acknowledged a lack of coordination between acute and community long term care services. Together with community partners, they developed the Real Choice Systems Grant. Funded by the Centers for Medicare and Medicaid, this is an interagency plan to coordinate services across systems for improving home and community service systems (University of Massachusetts Medical School Center for Health Policy and Research, 2004)

In New York, the Visiting Nurse Service (VNS) established a managed long-term care program based on an interdisciplinary care management model. At this time they have a membership of 3,800 and report reduced hospital admission rates. Moreover, nursing home utilization is below the rates projected for the program (Visiting Nurse Association of New York, 2004).

Finally, the state of Florida is piloting a managed long-term care program that links acute care and long-term care services for the geriatric population eligible for both

Medicare and Medicaid. Incentives are built into the program, which require the Managed Care Organization (MCO) to absorb costs in the event participants require nursing home care. A recent evaluation reports that < 8% of the participants utilized nursing homes and disenrollment rates are <2-3% a month and many of these are not voluntary. Participants remaining in their homes report fewer unmet needs (Department of Elder Affairs, 2004). While statistical data continues to be collected on these innovative delivery systems, they hold promise and provide models for communities like Central Florida to track for further research, modeling, and potential replication.

Rapid Rehabilitation and Aging Population

As a concept, Rapid Rehabilitation serves to provide multimodal rehabilitation to optimize discharge from the acute care setting and to return patients to their optimal level of function earlier in the continuum of care than would be expected if these services are not available to the patient (Berger et al, 2004, Bardram, Funch, & Kehlet, 2000). A number of studies have found rapid rehabilitation to be an effective, efficient and safe alternative to more traditional rehabilitation models. For example, a study by Berger et al, 2004, found that total hip replacement utilizing minimally invasive procedures and a rapid rehabilitation protocol was safe, and resulted in no complications for the patient and no readmissions to acute care setting.

In a British study by Bardram, Funch, & Kehlet (2000), patients underwent colon resection with minimally invasive procedures and were placed on a multimodal rehabilitation protocol to manage pain, ambulation, and oral nourishment. The median age for patients in this study was 81 years, and the authors report reduced length of

stay, reduced complications, and concluded that overall recovery was significantly improved. In cardiovascular services, minimally invasive procedures allows coupled with more rapid rehabilitation has demonstrated the same quality of outcome with significant degree of patient satisfaction (Schroeyers et al, 2001)

Despite the benefits of Rapid Rehabilitation found in the literature, the review yielded a paucity of research on rapid rehabilitation protocols linked to aging patients. A search of OVID Medline from 1996 to 2007 yielded 39 articles on rapid rehabilitation in adults, but only 1 article that specifically addressed rapid rehabilitation in the elderly patient. In the rapid rehabilitation study by Berger et al (2004) recovery rates were assessed in patients undergoing total hip replacements using minimally invasive techniques. Ninety seven percent of the patients met the criteria for early discharge, and the protocol was deemed to be beneficial and safe, and without readmissions. However, the recovery rates and age were not correlated. Bardram, Funch-Jensen, & Kehlet (2000) performed colonic resection using minimally invasive laparoscopic techniques on 50 patients with an average age of 81 years. A multimodal rehabilitation protocol supported rapid rehabilitation and included pain management, early mobilization, and nutrition. The length of hospital stay was reduced from 8-10 to 4-6 days. They conclude that a multimodal rehabilitation protocol combined with minimally invasive procedures improves recovery in the aging population.

Barriers to Health Service Data Sets

Barriers to health service data sets are problematic. The initial projected timeline for data collection for this research was three months after approval by appropriate

committees, and university and hospital Institutional Review Boards (IRB). An additional three months was projected for data analysis. However, this timeline was abandoned as barriers to quality information and access to administrative, clinical, financial, and information system data sets were encountered. Maio, Goldfarb, Carter & Nash (2003) concluded that health service information and data sets on quality are key better value-based strategies and purchasing activities. They performed a comprehensive review of the literature and reported a number of barriers such as the overwhelming number of measures, concern about the validity and reliability of information, and inconsistencies across reporting systems. Generally, hospitals and healthcare systems do not integrate administrative, clinical, financial, and information system data sets, meaning there is not a central repository for information that can be queried to correlate benchmarks or to collect large quantities of information for health services research (Advisory Board, 2005). This research found definitions for measures may not exist or may differ across data sets within the same organization.

The literature suggests that research utilizing health facility generated data is problematic and inherent in health services research. McCracken, McIlwain, and Fottler (2001) found the measurement of organizational performance to be a continuing major challenge. They believe factors driving the challenge are focused on competition in the marketplace, and the resulting reluctance of health service organizations to share information. Their research suggests the problem is compounded by the quality and format of information in health service information systems. A review of four hospital data warehouses by the Advisory Board (2005) acknowledges that some characteristics of healthcare services are challenging to quantify and suggests validity of the data may

be mistrusted by some stakeholders. Data warehousing systems may be costly, so hospitals must consider the potential of the applications and benefits of the technology.

Accountability for Hospital Data Sets

Along with academic scholars, regulatory agencies have recognized the problematic nature of health services data and are calling for systems to measure, analyze, and manage health services to establish knowledge data bases and integrated information systems. The Joint Commission on Accreditation of Healthcare Organizations (JCAHO) has acknowledged the problems inherent in the measurement of hospital performance and quality performance of services. As a result, the JCAHO continues to increase the number of indicators tracked each year, and to hold hospitals and hospital leadership responsible for the quality and integrity of hospital data (Willeumier, 2004).

Resolving Barriers to Research

The Agency for Healthcare Research and Quality (AHRQ), the Centers for Medicare and Medicaid Services (CMS), the National Cancer Institute (NCI), and Health Affairs (2004) sponsored an invitational meeting to acknowledge and address the growing volume of research that documents the increasing numbers of problems in health services, namely quality of services, safety, and efficiency. The groups present at the meeting agree that resolution of barriers must focus on improved technology, leadership, new delivery system designs, and incentive programs to transform the health care system.

In the most current literature, there is increasing evidence that health service organizations are making inroads to resolve the problems. The quest for performance excellence is evidenced by transformations and integration efforts, and a new body of health service research. The Baldrige National Quality Program (2006) supports health service organizations to improve the measurement of organizational performance and the quality improvement of programs, processes, and personnel to improve competition in the marketplace. Components of the program provide guidelines, definitions and performance indicators for this research.

Consensus of Standards and Measurements

While there are a number of innovative, strategic, and demonstration projects underway across the country, the literature suggests there are gaps in the quantity and quality of health services research. A randomized study by Weissert (2003) of twenty-four case managers in a long-term care facility concluded that risk and patient benefit information provided to case managers can improve services, and recommends prospective studies on patient outcomes and the economic effects of case management. In a review of 78 longitudinal studies to examine the..."models, measures, and methods" of the researchers... Miller & Weissert (2003) found standardization in the aging research literature to be lacking.

Summary

This chapter presents a theoretical review to discuss new venues for leadership and learning within healthcare service organizations to support the transformation of

healthcare delivery systems for the aging population. The chapter links these new venues with earlier theories on organizations and the historical evolution of hospitals. The literature review presents causal factors to link health and public affairs to the concerns for healthcare transitions and rapid rehabilitation in the aging population. The chapter concludes that managing healthcare transitions has the potential to increase the effective and efficient delivery of health services to all patients, and that further research is needed on multimodal rapid rehabilitation protocols for the aging population.

CHAPTER THREE: RESEARCH METHODOLOGY

This chapter serves to systematically describe the research procedures utilized to study a new Rapid Rehabilitation program designed to optimize the transition of patients from the acute care setting to the post acute setting in the community. The rapid rehabilitation model provides a broad range of services which are integrated across multiple settings operating within a large acute healthcare system in Central Florida. The intent is to improve healthcare services for the aging population.

The research design, sample selection, protection of human subjects, and data management are described. The study variables are identified, operational definitions provided, and concerns for validity and reliability are addressed. The analytical methods are discussed, and the analytical model is proposed. Measures of processes and outcomes at the patient level are of special interest, and indicators are selected to quantify the effective management of patient care and the efficient utilization of organizational resources to serve aging patients transitioning across a multiplicity of settings, services, payers, and providers.

Outcome measures, demonstrated by path coefficients between exogenous and endogenous variables, are anticipated to guide the discussion of cause and effect relationships (Wan, 2002) and contribute new research perspectives to the current literature on healthcare transitions for rapid rehabilitation. Lastly, there is intent to provide evidenced based information to ensure that valid and reliable data is available to draw inferences about healthcare transitions for the aging population.

Measurements in Healthcare Transitions

A large acute care health system serves as the setting for this research. The hospital system is ranked among the highest in the country for numbers of admissions and is among the largest Medicare providers in the United States. With more than 1000 aging patients admitted each month, the hospital has partnered with other stakeholders in the community to redesign healthcare transitions for elder care services with the intent to integrate acute and post acute care for the aging population.

The rapid rehabilitation protocol serving as the intervention in this research provides patients the option to transition from the acute care hospital, early in the continuum of care, to an outpatient, skilled nursing facility owned by the hospital organization. A unit within the outpatient facility has been designated for rapid rehabilitation patients. The purpose of the transition is to optimize the patient's discharge from acute care services.

The innovative program provides for multimodal rehabilitation. This means that an array of services and professionals dedicated to aging patients focus on early rehabilitation techniques to return patients to their optimal level of functioning earlier in the health services experience. The hospital believes the model reduces length of stay, decreases barriers to discharge, reduces readmission rates, reduces adverse events, and controls gross expenditures for acute patient care services. However, the value added by the rapid rehabilitation is unknown and the hospital seeks to learn more about the potential for multimodal rapid rehabilitation protocols through research, and the potential development and expansion to other hospitals within the hospital system.

Research Design and Framework

This is a quasi-experimental, cross-sectional, retrospective, and case-control matching design to study the effects of a rapid rehabilitation delivery model on healthcare transitions for aging patients admitted to an acute care health system and receiving an array of services from a multiplicity of providers in across settings. The research design is supported by a theoretical framework based on components found in the culture of the study organization, namely a servant leadership environment that sets high expectations for effective quality outcomes and efficient performance of processes. The acute care hospital setting is a learning environment that supports innovative protocols that benefit patients, and education for professionals serving the aging population.

Specification and Operational Definitions of Study Variables

Study variables are based on the review of the literature, theoretical framework, needs of the organization, the Baldrige National Quality Program indicators, availability, and quality of data sets, and two randomized trials of a similar model, Acute Care for the Elderly (ACE). Developed by the Cleveland Clinic, the ACE program is patient centered care delivered by an interdisciplinary team of geriatric professionals. The model provides for an interdisciplinary approach to discharge planning which integrates acute and post acute delivery systems, decreases length of stay in the acute care setting, and averts admissions to nursing homes (Palmer, Counsell & Landefield, 2003).

The recent trials were carried out at the University Hospitals of Cleveland and the Akron City Hospital. While the ACE studies support the effectiveness of the model to

improve functional status in the elder population, additional research is recommended to study healthcare transitions and models of care for this population (Palmer, Counsell & Landefeld, 2003). Additional recommendations in the literature include the need to address readmission rates, and continuity of care (Hong, Morrow-Howell, & Proctor, 2004). Hospital administrators and physicians continue to be concerned about the efficient utilization of resources to control costs, and effective leadership to assure that organizational performance provides benefits to patients (Palmer, Counsell, & Landefeld, 2003). The selection of study variables reflects the earlier research on the ACE model. Table 2 provides a summary of selected variables, specifies and defines the control variables, and presents final operational definitions.

Table 2: Variable Specification and Operational Definitions (Appendix A)

<i>Exogenous: Independent Variable</i>	<i>Operational Definition</i>
Rapid Rehabilitation	Intervention to optimize early discharge from acute care
Endogenous: Dependent Variables	
Efficiency	Latent construct, process of healthcare transition measured by the following indicators
Length of stay	Measure of time in days that patient is in hospital
Gross charges	Costs in dollars prior to contractual allowances
Barriers to discharge	Presence of an avoidable discharge delay from acute care setting to post acute care setting
Effectiveness	Latent construct, outcome of healthcare transition measured by following indicators
Readmission	Readmission to the hospital within 30 days of discharge, SPSS value assignment, 0=no , 1=yes
Patient safety	Falls occurring during the care experience
Proxy=Falls	SPSS value assignment, 0=no , 1=yes
Patient satisfaction	Overall satisfaction with quality of care, SPSS value assignment, Gallup scores at unit level
Control Variables	
Age	Age in years on admission
Gender	Male, female SPSS value assignment, 0=female, 1=male
Race	Race as defined by census data, coded by hospital SPSS value assignment, 0=white, 1=nonwhite
CMI	Case Mix Index reflects complexity of services provided to inpatients; measured at the patient level, CMI refers to the relative weights, resource consumption of case
DRG	Diagnosis Related Group code, assigns number to define primary admitting diagnosis
ICD9	International Code of Disease version 9, assigns unique number to describe needs, characteristics of case
Medicare/Medicaid	Qualified for Federal Medicare and state Medicaid programs, measures socioeconomic status SPSS value assignment, 0=female, 1=male
Hospitalist	Clinical care managed by physician with hospitalist credentials during admission to acute care facility SPSS value assignment, 0=no , 1=yes
Geographical location	Location of patient home, coded by zip code, provides data to study market service to community

Exogenous, Independent Variable and Intervention

The rapid rehabilitation program serves as the single intervention, and the independent, exogenous variable for the study. This is a newly designed delivery system, and there is increasing need to identify factors to evaluate the efficiency and effectiveness of the program. For the purpose of this study, the hospital uses the term rapid rehabilitation to mean the transition of the patient from the acute care setting, early in the continuum of care, to an outpatient setting for the purpose of rehabilitation to maintain and restore health and functional independence. Services may include medical and social services with some patients requiring support for a single impairment, but many receive multiple therapies, which may address needs for clinical, physical, cognitive and social services. The services provided by the rapid rehabilitation protocol follow the recommendations and position of the American Geriatric Society (1999) and take an interdisciplinary approach to healthcare services delivered to the aging patient.

Latent Constructs

The study design is intended to measure two latent constructs, described as the efficiency and effectiveness of the intervention, rapid rehabilitation. The barriers inherent in health services research and the causal relationship between efficiency and effectiveness created some challenges to define and operationalized the constructs, and to select indicators to measure performance. For the purpose of this research, the Baldrige National Quality Program (2006) provides the basis for the construct definitions. The construct efficiency has evolved to mean process, and defines how well the rapid rehabilitation program links activities to improve the length of stay rates and

the resulting costs of services. Efficiency is measured by three indicators (1) length of stay, (2) gross expenses, and (3) barriers to discharge from the acute care setting.

The construct *effectiveness* means outcomes and describes how well the rapid rehabilitation protocol performs the intended purpose to maintain and restore patients to an optimal level of health to decrease readmission to acute care in the hospital.

Effectiveness is measured by three indicators (1) readmission, (2) patient safety, and (3) patient satisfaction (Baldrige National Quality Program, 2006).

Endogenous, Dependent Variables

Definitions for all variables remain essentially unchanged since the inception of the research design. However, definitions for the endogenous, dependent variables evolved during the research design phase of the study. The final definitions for the indicators reflect data challenges relative to availability, reporting format, definitions across settings, and the subjective quality of some data sets. The constructs are The review of the literature supports the final operational definitions.

Efficiency Indicators

Length of stay in acute care hospitals is the primary determinant of health care costs and understanding those factors that cause aging patients to remain in the hospital is important to the proactive manage of healthcare costs (Lim, Doshi, Castasus, Lim, & Mamun, 2006). Prolonged stays increase the risk for complications, and places the aging patient at risk for functional decline (Palmer, Counsell, & Landefeld, 2003). Length of stay is utilized by hospitals, regulatory, and government agencies as a

measure of inefficiency (Leapfrog Group for Patient Safety, 2004). For this research, length of stay means the length of time the patient is admitted to the acute care hospital measured in number of days.

Barriers to discharge address the prolonged hospital stay of patients caused by discharge delays from the acute care setting that could be avoided. The study hospital defines discharge delays as three potential categories (1) physician delays coded in 17 sub-categories exemplified by lack of admission criteria, consult delay or scheduling delay, (2) hospital delays coded 47 sub-categories exemplified by test result delay, no available beds, inadequate staffing, and (3) external delays coded in more than 44 sub-categories exemplified by no available beds in community, no funding, or lack of transfer agreement. Avoidable discharge delays are utilized as an indicator for efficiency. For this research, the avoidable discharge delays defined by the study hospital, are collapsed and coded either (1) yes there was a barrier to discharge in at least one of the categories, or (2) no, there was no barrier to discharge from the acute care setting.

Costs of direct patient care for the aging are soaring and as a result, economic indicators are widespread in the literature. The Centers for Medicare & Medicaid (2006) reports enrollment in Medicare has increased to over 43 million recipients, and together with Medicaid, now represents about 19 percent of the total Federal budget. Finkler & Ward (2003) suggests that hospitals need evidence-based economic information to control costs, but assert that most hospitals have gaps between practice and efficient management of resources. Innovative delivery programs offer some opportunity to control costs. For example, research on early discharge protocols by Grines, et al

(1998) at William Beaumont Hospital found that early discharge of post myocardial infarction patients resulted in similar risks and outcomes for patients in the intervention and control groups, and resulted in reduced costs to the hospital. Similar studies of palliative care services (O'Mahony, Blank, Zallman, & Selwyn, 2005), and at specialty centers for Alzheimer's patients (Bloom, Chhatre, & Jayadevappa, 2004) found that innovative strategies to deliver services may provide no risks to patients and result in reduction of costs. Research by Finkler, Steven, & Ward (2003) suggest that hospitals must develop a framework for research to provide evidence for the efficient control of expenses. This is especially true as contractual discounts to payers increase, and reimbursement from Medicare remains inadequate (Ingenix, 2004, March). For this research, gross expenses are defined as the total cost of direct patient care prior to the contractual allowances negotiated with payers.

Effectiveness Indicators

Readmission rates for the aging population are problematic and may be driven by functional decline during acute hospital the acute hospital stay. Greater than 30 percent are discharged with less ability to perform activities of daily living than were present on admission (Landefeld, 2003). Generally, the literature defines early readmission as less than 30 days after discharge exemplified by Timms, Parker, Fallat, & Johnson (2002). They documented an early readmission rate of 12.5 days, but noted there were gaps in the hospital data. A comprehensive review of the literature on coordination of care between settings by Parker, Lee, & Fadayeatan (2006) suggests that coordinating transitions between acute and post acute settings may reduce

readmission rates by 17 percent. By definition, *readmission* means the readmission of the patient to the acute care setting within 30 days after discharge.

Patient safety continues to be a concern of all stakeholders. The Institute of Medicine (1999) called attention to patient safety when they estimated that greater than 44,000 people die each year as a result of adverse events in American Hospitals. Their work began a focused effort to improve quality and safety that is now in the third phase. However, the U.S. Department of Health and Human Services (2007) Agency for Healthcare Research and Quality (AHRQ) reports that a high rate of avoidable adverse events continues to harm patients, and believes that evidenced based data to determine how to resolve the safety issues is not available. The Joint Commission on the Accreditation of Hospitals (2007) has approved new safety requirements for hospitals that include goals for hand offs or transitions, and accuracy of hospital information. For this research, patient *safety* is measured by the proxy patient *falls* rather than all adverse patient events. This decision was based on the availability of objective data to document falls, and the potential for other adverse events to be confounded by subjective reporting format.

Patient satisfaction was the most problematic of the indicators to define. The Gallup organization provides an ongoing survey to assess patient satisfaction for the study hospital system. Patients are randomly selected for the survey and contacted 2-4 weeks after discharge and asked to respond to a set of 25 questions to quantify satisfaction with an array of services, and experiences. In addition to the Gallup Survey, patients opting for rapid rehabilitation may receive a less formal satisfaction survey about their outpatient experience. However, the origin, validity and reliability of the

outpatient instrument are unknown, and administration during the study year of 2005 was inconsistent, meaning the data was incomplete and subjective, and not a viable data resource.

As a result, criteria from the Baldrige National Quality Program (2006) were utilized to define this indicator. They suggest that patient centered processes should include patient perception indicators and overall satisfaction was selected as the most comprehensive measurement of this indicator. The data source for the variable is the Gallup Patient Satisfaction data measured at the nursing unit level and stratified to extract scores for patients ≥ 65 years of age.

Research Population and Sampling Plan

The theoretical population for the study is all people in the United States ≥ 65 years of age. However, the accessible sampling frame for this proposal is limited to people ≥ 65 years of age in the state of Florida and is further limited to people in Central Florida admitted to the participating hospital system.

Eligibility Criteria

The sampling plan is guided by the eligibility criteria for the rapid rehabilitation program and inclusion and exclusion criteria established by the hospital organization for transition to the rapid rehabilitation unit defined as an outpatient, skilled nursing facility owned by the hospital organization. Inclusion criteria for patients are based on (1) potential for admission to the rapid rehabilitation unit, (2) age ≥ 65 , qualified for the Medicare program, (3) capable of participating in a functional rehabilitation program,

and (4) anticipated length of stay less than two weeks. Exclusion criteria is defined as the (1) requirement for critical care level services, (2) the diagnosis of an active gastrointestinal bleed, (3) patients that are comatose, require a ventilator for support, or (4) intravenous medications for medical care. Table 3 summarizes the eligibility criteria.

Table 3: Eligibility Criteria and Operational Definition

Inclusion Criteria	Operational Definition
Rapid Rehabilitation	Transition to rapid rehabilitation, no exclusion factors
Medicare	Qualified for Medicare program
Functional status	Anticipated length of rehabilitation \leq 2 weeks
<i>Exclusion Criteria</i>	
Level of services	Critical care level of services
Diagnosis	Active gastrointestinal bleed
Life support	Comatose, requiring ventilator support
Intravenous medications	24 hour intravenous medications

Sample Size and Power

This is a quasi-experimental, cross-sectional, retrospective research design using case-control matching techniques to draw a control group to match the intervention group as closely as possible. Determining sample size is a sophisticated procedure requiring software and advanced statistical skills beyond the scope of this research (Polit & Beck, 2004, Wan, 1995). Therefore, basic research principles and rule of thumb techniques are employed to establish the sample size (Granger & Chulay, 1999, Wan, 1995). It is assumed that the population will be fairly heterogeneous, and the effect size or relationships between the exogenous and endogenous variables is expected to be modest. The sample size is based on the number of study parameters

and projected to be 50 patients in the intervention sample and 50 patients in the control group or as a general guideline, 5 patients per factor. However, the final sample size is doubled to 100 patients in the intervention sample, and tripled to 150 patients in the control sample to address the heterogeneity and the effect size inherent in the sample. The increased sample size is projected to provide a confidence interval near 95 percent, and to improve the potential for the findings to be generalized to other patient populations served by the hospital system.

Sampling Plan

The final sample of 250 patients represents both the intervention and the control group. Group one is intervention sample and is defined as all patients admitted to the Rapid Rehabilitation Program in 2005 who meet eligibility criteria of the study and the inclusion and exclusion criteria for Rapid Rehabilitation. This is a convenience sample drawn using non-probability sampling techniques. Group two is the control sample, and patients are matched to the intervention group based on case-control methods to match the groups. In this design, groups are matched as nearly as possible for demographics and clinical diagnosis data with the primary difference being the transition to rapid rehabilitation, and exposure to the intervention of early discharge. To control for bias, the control group is randomly matched to the intervention group through a computer software established within the security of the hospital information system. Each patient entered into the study is followed across the continuum of care to include initial admission to the acute care setting, transition to rapid rehabilitation unit for the

intervention group, readmission to acute care within 30 days of discharge, and finally discharge to post acute care in the home or community.

Protection of Human Subjects and Data Management

While there are no known risks or benefits to patients in this research design, it should be noted that all information collected is de-identified and reported as aggregate data. Preliminary data was stored in secured and locked files in the office of the researcher on hospital property, and was destroyed after de-identification. The study followed all identified regulations specified by the Health Information and Portability Act (HIPAA). The researcher is certified in the protection of human subjects by the National Institutes of Health (2005) and has completed HIPAA education for researchers (Muhlbaier, 2002). After approval of the dissertation committee, the proposal was submitted to the University of Central Florida Institutional Review Board (IRB) and to the IRB of the participating hospital. Data collection began after written approval of boards.

Data Sources

Data sources are described as reports from the acute care organization and from the transitional healthcare facility in the community. Focused meetings with individuals resulted in reports from Finance, Case Management, Risk Management, Strategic Planning, and demographic and clinical data from patient medical records as approved by the hospital Institutional Review Board. In addition, the Gallup Survey data is provided by the hospital. Table 4 provides an overview of the data sources and descriptions for the study.

Table 4: Data Sources and Description

Data Source	Description of available data
Acute care organization	Database reports from Finance, Case Management, Risk Management, Strategic Planning, Marketing and access to patient medical records per IRB approval
Transitional care facility	Database reports from Finance, Case Management, Risk Management, Strategic Planning, and access to patient medical records per IRB approval

Validity and Reliability of Data

As stated by Wan (2002), validity and reliability are not independent qualities and are considered important to the identification of the measurement tools for the proposal. In this research, internal threats to validity are controlled through the sample plan and the case match methods used to establish the control and experimental group characteristics. The external threats to validity, mortality and attrition are inherent in the design. Efforts to control external threats to validity focus on increasing the sample size, and the case-match methods used to select the control group (Wan, 1995).

Analytical Methods

The current health care environment is undergoing constant change in economic policy, and shifts in the options, and mechanisms available to finance health care services and new strategies are needed to address the efficient and effective operation of the organization (Rotarius & Liberman, 2000). There is an ongoing need to bridge the gaps in quality of care (NCQA, 2004), demands to provide a safer environment of care (JCAHO, 2007), and recommendations to improve healthcare transitions as patients

and families attempt to navigate the complexities of the environment of care (Coleman, 2003, Coleman, Smith, Frank, Min, Parry, & Kramer, 2004, Covinsky, 2003).

The analytical methods for this research will focus on 4 areas of analysis:

1. Descriptive analysis of demographics and comparison of clinical characteristics of intervention group to those of control group, and to general population.
2. Development of a conceptual model of two theoretical constructs, inefficiency of processes and ineffectiveness of outcomes is presented, assigned indicators.
3. Path analysis to examine the principal concepts and hypotheses of the model.
4. Discussion of structural equation modeling as an analytical method to measure and monitor the processes and outcomes of healthcare transitions.

Evidence-Based Healthcare Services

Collectively, there is a call for leadership, accountability, new delivery systems, data driven performance, and a quest for performance excellence to transform and improve the healthcare system and interest in evidence-based management is expanding (Wan, 2002). Researchers are being called upon to resolve barriers inherent in health services research (McCracken, McIlwain, and Fottler (2001) to collaborate on strategies that are predictable and provide benefits to patients (Rotarius & Liberman, and to develop new methodologies to analyze and evaluate the new processes, outcomes, and structures while constraining expenditures (Wan, 2002).

Path Analysis and Statistical Models

Health services research serves to ensure the quality and integrity of evidence-based health services information and analytical methods exist to organize, evaluate, and communicate the outcomes of analytical evaluations (Polit & Beck, 2004), provide an integrated approach to managerial decision making (Wan, 1995), and support patient interventions (Vabey, Corser & Brennan, 2001). A multiplicity of analytical methods exists to support health services research, and the researcher proposes rationale for the selection and preference of the method with the most flexibility to study the complex relationships in health care services. Standard multiple regression offers the researcher an ability to explore how well the set of dependent variables predicts the performance of the independent intervention, which variable is the best predictor, and whether the predictor variable remains the same when controls are in place (Pallant, 2003), but in more recent years is being enhanced by path analysis and structural equation modeling (Stoelting, 2002).

Path analysis is the analytical method of choice for this research. The method incorporates multiple regression techniques, and provides the unique benefit to examine direct and indirect relationships. This means that mediated pathways can be investigated (Stoelting, 2002), and in the complexities of health services research, this is deemed beneficial by the researcher. Additionally, analytic reports may be depicted as diagrams to exemplify key concepts (Polit & Beck, 2004), and this is considered beneficial for teaching and learning. Path analysis is a component of structural equation modeling (SEM) procedures. SEM extends the regression methods, includes the advantage of employing unobservable constructs to estimate and test the hypotheses

Wan, 2002), and like path analysis, provides path diagrams as visual representation of complex relationships (Polit & Beck, 2004). While SEM is not fully developed in the course of this study, the methodology is utilized within the study hospital. Utilization of path analysis for this research provides the opportunity to expand regression methodology options and provides a foundation for the development and eventual utilization of structural equation models within the acute care and post acute care environments supporting this research. Descriptive statistics will be utilized to characterize the sample population. Analysis of Moment Structures (AMOS) version 7.0 will be employed to develop analytic path models to examine the relationships among the selected variables.

Summary

This chapter serves to systematically describe the research procedures utilized to study a new Rapid Rehabilitation program designed to optimize the transition of patients from the acute care setting to the post acute setting in the community. In response to the significant need to improve healthcare transitions and to develop and monitor deliver systems for the aging population, this chapter proposes an analytical model to study the transition to rapid rehabilitation, and identifies 3 indicators to measure the latent construct, inefficient processes and 3 indicators to measure ineffective outcomes. The chapter concludes with the benefits of statistical modeling as an analytical methodology to measure and monitor healthcare transitions.

CHAPTER FOUR: FINDINGS

This chapter presents data analysis and findings on the complex relationships present during healthcare transitions from an acute care hospital to a rapid rehabilitation unit in the community. The study examines the efficiency of processes and effectiveness of outcomes for aging patients participating in the program. This is a newly implemented rehabilitation model delivered within a complex, acute care medical system. The purpose of the rapid rehabilitation program is to maximize the opportunity for patients to be discharged from the acute care setting. However, little is known about the predictors for successful healthcare transitions. The value of the rapid rehabilitation program to contribute to the delivery of efficient and effective healthcare services is yet to be determined. The findings in this chapter are obtained through a quasi-experimental, cross-sectional, and retrospective design with a total sample of 250 patients. The study sample is composed of a convenience sample of 100 patients in the intervention group, and a random, case control matched sample of 150 patients in the control group.

The chapter begins with the analysis of descriptive demographic characteristics and comparison of clinical characteristics of the intervention group to those in the control group. A case-control methodology is employed to match the patients as closely as possible for age, gender, race, diagnosis, and complexity of case (Polit & Beck, 2004). Descriptive results assess how well the intervention group is matched to the control group, and provides an overview of the representativeness of the study sample to the general population at the state and national levels. Descriptive analysis of clinical characteristics compares the clinical characteristics from the perspective of the

assigned Diagnosis Related Group (DRG) for the primary diagnosis, the unique needs of the patient presented as the International Code of Diseases (ICD-9), and complexity of the services reflected by the Case Mix Index (CMI). In addition to the demographic data, three control variables are of special interest, and these are described as management of care by a hospitalist, economic status of the patient, and geographical location of the study sample.

Model generating and path analysis is discussed as the analytical methodology and conceptual measurement model of the two theoretical constructs, efficiency of processes and effectiveness of outcomes is presented. Definitions are provided for the theoretical constructs and six exogenous variables are proposed to predict successful healthcare transitions.

After conceptualizing the statistical model, this research employs path analysis to examine the relationship patterns and standardized regression coefficients (P_{ij}) among selected indicators (Wan, 2002). Analytic path diagrams and structural models are presented, analyzed, and modified based on the modification and goodness of fit indices. The intent of analysis in this section is to examine the principal concepts, and evaluate the hypotheses imbedded in the analytic path diagrams (Polit & Beck, 2004).

The chapter summarizes findings and potential for multi-dimensional modeling as an analytical method to evaluate evolving delivery models within healthcare systems. The author strives to demonstrate the potential to predict successful healthcare transitions for the aging population through transformation of data into clearly defined predictors to ensure inferences drawn about processes and outcomes of healthcare transitions have their basis in quality information (Selden & Sowa, 2004)

Analysis of Demographic Characteristics

The research includes a total sample of 250 patients representing both the intervention and the control group. The first group, referred to as Group I, represents intervention for this research, and consists of 100 patients transitioned to rapid rehabilitation in the community to optimize the opportunity for early discharge from the acute care setting. The group is defined as all patients ≥ 65 transitioned to rapid rehabilitation in 2005, and who met eligibility criterion for rapid rehabilitation program and inclusion and exclusion requirements of the research study. The intervention group is composed convenience sample drawn using non-probability sampling techniques.

The control group, referred to as Group II, consists of 150 patients randomly selected from all patients, age ≥ 65 , admitted to the study hospital in 2005 during the same study timeframe of Group I. Group II received traditional care and remained in acute care for the duration of their convalescences. The hospital strategic information staff utilizing administrative, statistical software, and case-control methods, provided by the investigator, matched the control sample to the intervention sample.

Descriptive analysis focused on how well the groups were matched for personal demographics as represented by age, gender, race, and clinical characteristics captured by three control variables, (1) primary clinical diagnosis or assigned Diagnosis Related Group, (2) specific patient as represented by the International Code of Disease (ICD9), and (3) complexity of the case or Case Mix Index. All statistical data is derived utilizing Statistical Package for the Social Sciences (SPSS) 15.0.

Descriptive Demographic Characteristics

Total sample age ranges from 65-100 years with a mean age of 80 (6.4%) with greater than half of the sample greater than age 80, and 79 (31.6%) patients greater than age 85. Gender of the sample is represented by females 183 (73.2%), and males 67 (26.7%). Race is white 183 (73.2%), and nonwhite 67 (26.8%).

Group I, which participated in the rapid rehabilitation intervention, ranged from age 65-100 with a mean of age 80. Group I consists of females 73 (73.0%), and males 27 (27.0%). The race of Group I is white, 73 (73.0%), and nonwhite 27 (27%). Group II, which is the control sample, ranges in age from 65-99, with 110 (73.3%) females and 40 (26.7% males). The race of Group II is white 110 (73.3%) and nonwhite 40 (26.7%). The study is a retrospective, cross-sectional design with data collection completed on all 250 patients, without the loss of participants secondary to attrition factors. Overall, descriptive demographic characteristics (Table 5) portray the comparability between the two study groups.

Table 5: Descriptive Statistics of Demographic Characteristics

	Total Sample ^a		Group I Intervention ^b		Group II Control ^c	
Age	Range	65-100	Range	65-100	Range	65-99
	Mean	80	Mean	80	Mean	80
Gender	Male	67 (26.8%)	Male	27 (27.0%)	Male	40 (26.7%)
	Female	183 (73.2%)	Female	73 (73.0%)	Female	110 (73.3%)
Race	White	183 (73.2%)	White	73 (73.0%)	White	110 (73.3%)
	Nonwhite	67(26.8%)	Nonwhite	27 (27.0%)	Nonwhite	40 (26.7%)

Note: ^an=250; ^bn=100; ^cn=150

Comparison between Study Sample and General Population

The study sample was compared to state and national demographic data (Table 6) to assess representativeness of the sample to overall aging population (U.S Census Bureau, 2000). Nationally, the population ≥ 65 represents 12.4% of the general population and has a mean age of 74 years with 1.5% ≥ 85 . Overall, the population is 78% white and 22% nonwhite, with males representing 49.3% of the population and females 50.7%. Florida ranks first among the states for percentage of aging population with 17.6% in this age group, and 2.1% of the group ≥ 85 . The state population is 75% white and 25% nonwhite, with males 49% of the population and females 51%. From an age perspective, the sample mean is 5.4 years older than national mean and has a greater percentage of population ≥ 85 (31.6%) than the nation (1.5%) and state (2.1%). The ratio of females to males is greater in the study sample than the nation and state with females (73.2%) and males (26.8%). From a demographic perspective, the study sample is more consistent with the majority race of the nation and state at 73.2% white and 26.8% nonwhite, respectively.

Table 6: Demographic Characteristics Compared to State and National Population

	Total Sample $\geq 65^a$		Florida $\geq 65^b$		National $\geq 65^c$	
Age	Mean	80	Mean ~	74	Mean~	74
	≥ 65	100%	≥ 65	17.1%	≥ 65	12.4%
	≥ 85	31.6%	≥ 85	2.1%	≥ 85	1.5%
Gender	Male	26.8%	Male	49.0%	Male	49.3%
	Female	73.2%	Female	51.0%	Female	50.7%
Race	White	73.2%	White	75.0%	White	78.0%
	Nonwhite	26.8%	Nonwhite	25.0%	Nonwhite	22.0%

Note: ^an=250; ^b U.S. Census Bureau, 2000 (n=2,807,597); ^c U.S. Census Bureau, 2000, (n=15,982,378)

Analysis of Clinical Characteristics

Clinical characteristics of the patient population provide the most challenge to control. Three variables are selected to manage confounding factors associated with clinical aspects of the study, and to support case-match of the two groups: (1) Diagnosis Related Groups (DRG) represents the primary diagnosis, (2) International Code of Disease (ICD9) captures the unique needs of the patient, and (3) Case Mix Index (CMI), which is the weighted average of the DRG for inpatients, reflects the complexity of services provided to the patient.

Primary Clinical Diagnoses

The study groups are compared by frequency of primary clinical diagnosis based on diagnosis related group (DRG) assignment, and then compared to the top ten national DRGs by prevalence of case volume. Yale University developed the DRG classification system was developed in the early 1980s, Medicare. The intent is to group patients with similar utilization of resources. The work is supported by the Health Care Financing Administration, which is now the Centers for Medicare and Medicaid Services (CMS). In study year of 2005, the system included approximately 543 classifications and continues to evolve in response to the sophistication and needs of the American healthcare system (Agency for Healthcare Research and Quality, 2006). Frequencies of the diagnoses, based on DRG assignment (Appendix B), demonstrate the study sample represents 49 of the approximate 543 classifications. Intervention and control groups are well matched for 46 of the 49 DRGs.

Diagnoses Compared to National Case Volume

The volume of high cost cases account for greater than thirty percent of total Medicare payments for inpatient services (American Hospital Directory, 2002), and U.S hospitals report those costs are greater than reimbursements for the top ten diagnoses (Data Advantage Corporation, 2002). The study sample is compared to the top ten Diagnosis Related Groups in the national population (Table 7) based on the prevalence of case volume. This is done to assess the representativeness of the study sample to national DRG data. The study sample was found to represent 8 of the 10 most prevalent diagnoses. Comparative data is not available in the study sample for digestive disorders (DRG182), or chest pain (DRG143). Prevalence in the study sample is highest for septicemia (DRG 416) and heart failure and shock (DRG 127), and is the same as national prevalence for gastrointestinal hemorrhage (DRG 174).

Table 7: Comparison of Diagnosis Related Groups by Prevalence of Case Volume

DRG	DRG Description	National Rank ^a	Sample Rank
127	Heart failure, shock	1	2
089	Simple pneumonia, pleurisy	2	4
209	Major joint, limb reattachment, procedure of lower extremity	3	5
088	Chronic obstructive pulmonary disease	4	7
182	Esophagitis, gastroenteritis, miscellaneous digestive disease	5	0 ^b
416	Septicemia Age >17	6	1
014	Specific cerebrovascular disorders, except TIA	7	3
174	Gastrointestinal hemorrhage	8	8
296	Nutritional, miscellaneous metabolic disorders	9	6
143	Chest Pain	10	0 ^b

Note: ^aData Advantage (2005), ^bNo comparative data for DRG 182 and DRG 143

Major Diagnosis Categories and ICD9 Codes

Based on the Diagnosis Related Group assignments, the study sample diagnoses were collapsed into Major Diagnostic Categories (Table 8) which clusters all diagnoses into 25 general categories based on organ system, and medical specialty (Agency for Healthcare Research and Quality, 2006). This coding system simplifies complexities of the DRG and ICD9 codes, and provides an overview of how well intervention and control groups are matched. The study sample represents 10 of the 25 categories with groups well matched in 9 of the 10 categories. A case-control match was not available in the control group for MDC 11, injuries, poisoning, and toxic effects of drugs.

Table 8: Frequency of Diagnosis by Major Diagnostic Category (MDC)

Description ^a	MDC	Group I: Intervention ^b		Group II: Control ^c	
		Frequency	%	Frequency	%
Nervous System	1	12	.12	14	.09
Respiratory System	4	13	.13	15	.10
Circulatory System	5	26	.26	40	.26
Digestive System	6	8	.08	14	.09
Hepatobiliary system, pancreas	7	1	.01	4	.02
Musculoskeletal System	8	24	.24	48	.32
Skin, subcutaneous tissue, breast	9	1	.01	1	.007
Endocrine, Nutritional, Metabolic System	10	2	.02	1	.0
Kidney, urinary tract	11	2	.02	6	.04
Infectious and Parasitic Diseases	18	6	.06	4	.02
Mental diseases, disorders	19	1	.01	2	.01
Injuries, poisoning, toxic effects of drugs	21	1	.01	0	.00
Other factors influencing health status	23	3	.03	1	.05
Total		100	100	150	100

Note: ^a Data Advantage, 2005, ^b n=100, ^c n=150

Control Variables

Beyond the demographic controls, three additional variables focus on issues of special interest in the demographic analysis of this research. The variables are believed to impact healthcare transitions during rapid rehabilitation, (1) case management by a hospitalist, (2) economic status of patient based on Medicaid qualification, and (3) the geographical service area where a patient resides.

Hospitalist and Case Management

Earlier studies by Diamond, Goldberg, & Janosky (1998) demonstrated the management of care by a hospitalist decreased length of stay in the acute care setting

and improved patient outcomes. In the current healthcare environment, there is increasing interest that hospitalists may provide similar benefits to the aging population (Wald, Huddleston, & Kramer, 2006). To obtain this data, all appropriate databases were searched for clinical consults, and the resulting list of physicians matched by specialty, and further compared to the list of hospitalists with medical staff privileges within the study hospital. In the total sample of 250 patients, 106 (42%) received care managed by a hospitalist sometime during their stay in the acute care facility; 46 (46%) of the intervention group, and 60 (40%) of the control group.

Medicare and Medicaid as Payer

Increasing financial strain on the state and hospitals to provide care to uninsured, and indigent creates the need to describe economic status of the study sample. While the state has initiated a wide range of new policies, there is little known about the effects of new programs (Yemane & Hill, 2002). In this research, qualification for Medicaid as a payer is used as economic status of the patient. Florida is an income cap state, which means an individual's gross monthly income may not exceed \$1809 including the premiums for Medicare part B. Of increasing concern is long-term care, which is estimated to cost between \$48,000- \$70,000 annually (Florida Medicaid, 2007).

As an inclusion criteria, all patients in the study are ≥ 65 and qualified for Medicare program. In the study sample of 250 patients, 31(12%) patients qualified for financial assistance from the Medicaid program; 9 (9%) in the intervention group, and 22 (14.7%) in the control group. Documentation for long term care insurance is not found (0%) among the 250 patients in the study.

Geographical Service Area

The geographical service area provides hospital administrators with information to assess the need for services in the community and to develop strategic plans to expand or alter services based on utilization in the community. In this study, zip codes are utilized to obtain this data. Ten counties within the state are represented in the study sample with 209 (84%) of the patients residing within Orange (64%) and Seminole (19%) counties. Both counties are in close proximity to the geographical location of the study hospital. In the intervention sample, 5 patients resided outside the state. In the control sample, 1 patient listed another state as a permanent address. The geographical service area for three patients could not be matched to documented postal zip codes.

Path Analysis and Statistical Modeling

The interest in path analysis and statistical modeling as a potential methodology to measure healthcare transitions is driven by the opportunity to provide hospital administrators and clinical managers with new methods to manage the efficiency and effectiveness of delivery models while improving the quality of care (Wan & Connell, 2002, Wan, 2002). This research employs path analysis methods and provides six analytic path models to examine complex relationships among principal concepts and to test hypotheses proposed for the study (Polit & Beck, 2004). Path analysis provides the opportunity to identify and test those observed indicators that best describe and measure hypothetical concepts that can not be observed, and presents the flexibility to

cope with difficult data (Garson, 2007). While structural equation modeling is not fully employed in this research, a conceptual model (Figure 6) supports this research.

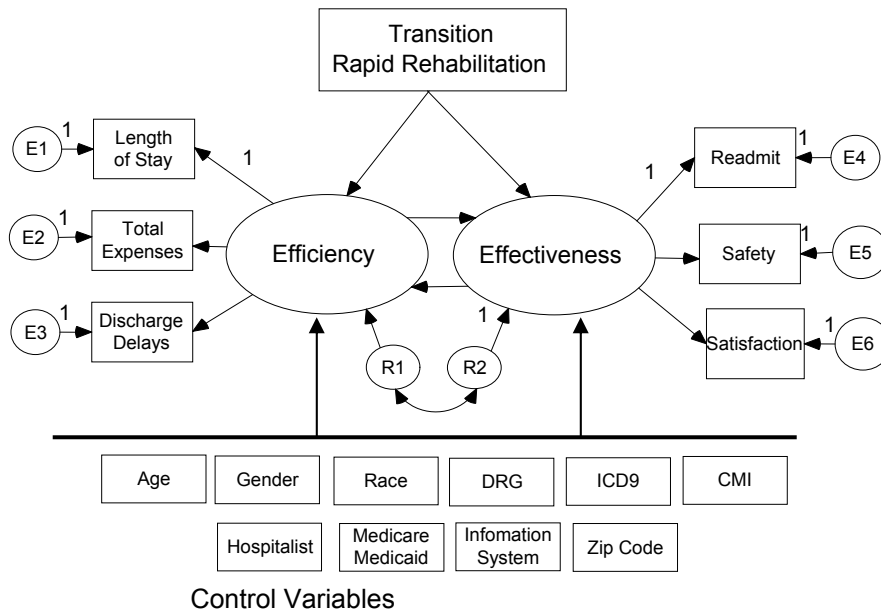

Figure 6: Conceptual Structural Equation Model for Healthcare Transitions

In the conceptual model, efficiency is a latent construct and in this research efficiency means the process of transition from an acute care setting to a rapid rehabilitation unit operating within a transitional care facility in the community. For the purpose of this research, the Baldrige National Quality Program (2006) provides the foundation for construct definition. The following predictors are meant to define how well the rapid rehabilitation program links process activities to improve length of stay rates and resulting costs of services. These are selected based on classic measurements in the literature and discussions with administrative and clinical staff of the study hospital.

Efficiency is measured by three predictors (1) length of stay, (2) gross expenses before contractual allowances, and (3) barriers to discharge from the acute care setting.

Analytic Path Models of Inefficiency

The predictors for the latent construct, inefficiency, are inverted and presented as Table 9. The total sample demonstrates a mean LOS of 7.73 days compared to the intervention group (9.17) and the control group (6.77). Cost of care for the total sample had a mean charge of \$43,373. Mean expenses were higher for intervention group (\$57,846) than for control group (\$33,723). Twenty-one discharge delays (8.4%) are abstracted for the total sample, with the intervention group experiencing 9 delays (9%) and the control group 12 delays (8%). The descriptive statistics suggest the most complex cases are transitioned to rapid rehabilitation unit to optimize discharge from an acute care hospital, and to provide continued support in the outpatient setting.

Table 9: Descriptive Statistics for Predictors of Inefficiency

	Total Sample ^a	Group I Intervention ^b	Group II Control ^c
Length of stay	Range 1-47	Range 1-43	Range 1-47
	Mean 7.73	Mean 9.17	Mean 6.77
Total Expenses	Range 1248- 388,604	Range 1,248-388,604	Range 4,835-193,290
	Mean 43,373	Mean 57,846	Mean 33,723
Discharge Delays	21 (8.4%)	9 (9%)	12 (8%)

Note: ^an=250; ^bn=100; ^cn=150

Modeling Length of Stay

Length of stay (LOS) is defined as the measure of time the patient is in an acute care setting and is measured in 24-hour days. LOS is an important indicator for proactive management of health care costs (Lim, Doshi, Castasus, Lim, & Mzmun, 2006). A reduction in LOS is believed to reduce risk for complications including functional decline of the patient (Palmer, Counsell, & Landefeld, 2003).

Analytic Path Model for Length of Stay

Figure 7 is a path model for LOS with relationships postulated to have a direct impact, presented as standardized regression coefficients (P_{ij}). Eight exogenous variables serve as indicators. These are the transition to care facility (TCF) for rapid rehabilitation (X1), age (X2), gender (X3), DRG (X4), ICD9 (X5), case mix index (X6), hospitalist as provider (X7), and Medicare/Medicaid as payer (X8). Collectively, the eight variables explain 16 percent of total variance with case mix index (X6) the strongest of the indicators (30%). The intervention, transition to rapid rehabilitation, (X1) demonstrates a positive relationship to LOS (14%). The indicators DRG (X4), and ICD9 (X5), provide slight influence (12% and -12% respectively). A chi-square of 51.20, significant p -value ≤ 0.05 , and goodness of fit scores outside the recommended range on TLI, NFI, and RMSEA demonstrate an inadequate model. Therefore, the path model for LOS is assessed for modification.

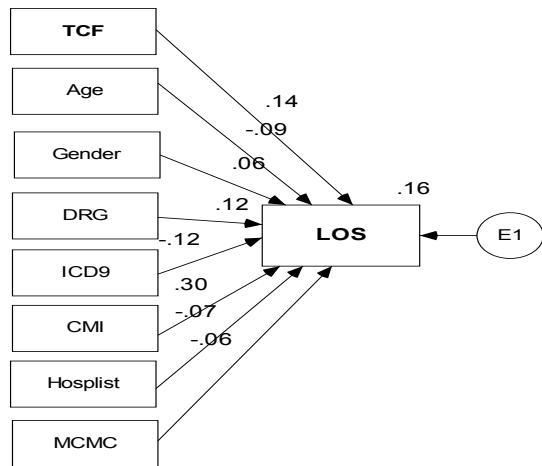

Goodness of Fit Measures (GOF)	
Chi-Square (X^2)	51.20
Probability (p)	.005
Degrees of freedom (df)	28
Likelihood ratio (X^2/df)	1.828
Goodness of fit (GFI)	.958
Adjusted GFI (AGFI)	.932
Tucker Lewis Index (TLI)	.555
Normed Fit Index (NFI)	.503
Root Mean Square Error of Approximation (RMSEA)	.058
Hoelter's Critical N (CN)	202

Note: TCF=transition to rapid rehabilitation, CMI=case mix index, MCMC=Medicaid as payer

Figure 7: Analytic Path Model for Length of Stay with GOF Measures

Modified Analytic Path Model for Length of Stay

The modified analytic path model for LOS (Figure 8) retains six of the original exogenous variables, transition to care facility (TCF) for rapid rehabilitation (X1), age (X2), gender (X3), DRG (X4), ICD9 (X5), and case mix index (X6). Hospitalist as a provider (X7) and Medicare/Medicaid as a payer (X8) contributed minimally to the original model and were not retained. The direct effect of each exogenous variable (X1-X6) on the endogenous variable, length of stay (Y1) is analyzed. The modification indices suggests indirect relationships between (X1- X6), (X1-X6), and (X2-X4), and these are depicted in the modified model (Figure 8).

Collectively, the variance explained by the revised model is improved to 18 percent without change in path coefficients. Covariance between (X1-X6), (X2-X6, and (X2-X4) were 13%, -21%, -20% respectively. The chi-square was reduced to 17.57, and a p-value $\geq .05$. The goodness of fit statistics are below the recommended criterion on

the Tucker Lewis Index (TLI) and Normed Fit Index (NFI). The remaining goodness of fit measures are within the recommended range (Table 11).

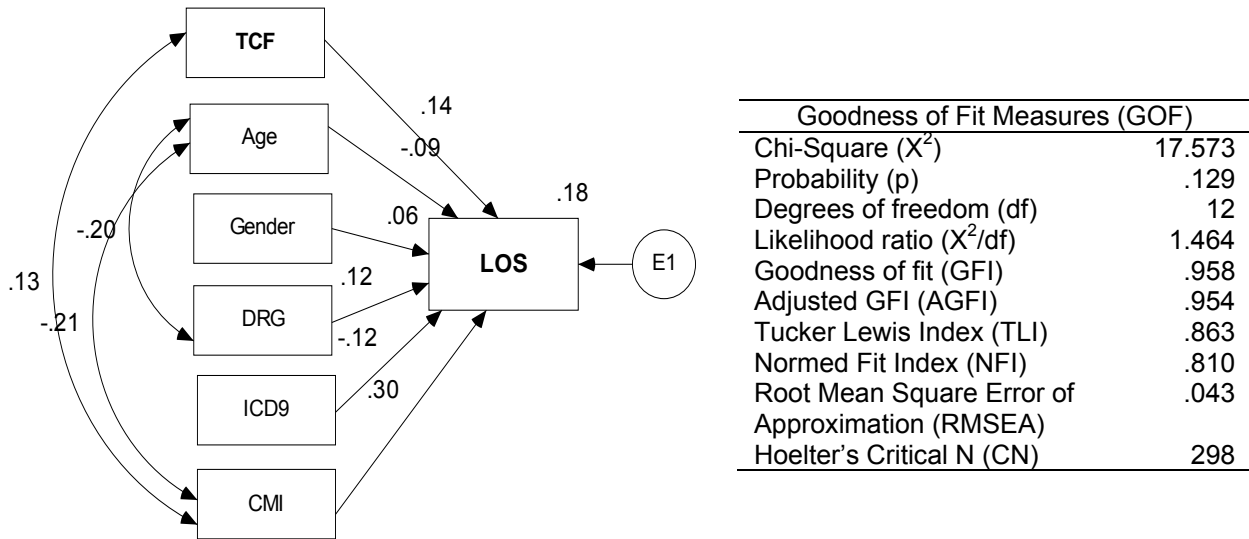

Note: TCF=transition to rapid rehabilitation, CMI=case mix index

Figure 8: Modified Analytic Path Model for Length of Stay with GOF Measures

Analysis of Length of Stay

Assessing the relative importance of path coefficients for the LOS variable, finds that case mix index (X6), or the complexity of the case remains the strongest indicator for length of stay (30%), and demonstrates a critical ratio that is statistically significant ($p \leq .05$) (Table 10). As expected, the diagnosis (DRG) and unique needs and characteristics of the patient (ICD9) contribute to the variation in length of stay (LOS), (12% and -12%, respectively). The intervention and transition to rapid rehabilitation (X1) provides a positive influence on the model (14%). Based on modification indices, indirect relationships between three of the exogenous variables (X1-X6), (X2-X6), and

(X2-X4) are assessed. A positive relationship (13%) is found between transition to a care facility for rapid rehabilitation (X1) and case mix index (X4), suggesting that patients requiring the most complex care are transitioned to rapid rehabilitation to optimize discharge from the acute care setting. An inverse relationship is found between age and case mix index (-20%), and age and DRG (-21%) suggesting that complexity of care increases with age and that complexity of care contributes to length of stay.

The analytic path models for length of stay (LOS) demonstrated a chi-square difference (ΔX^2) of 33.62 and a statistically insignificant p-value of .129. The goodness of fit measures for Tucker Lewis Index (TLI) and Normed Fit Index (NFI) are improved (.863 and .810 respectively), but slightly below the recommended criterion. Goodness-of-fit statistics for remaining measures are within the recommended range. A comparison of the goodness of fit statistics for the LOS models is provided in Table 11, and demonstrates an improved fit for length of stay.

Table 10: Parameter Estimates for Length of Stay

Variable	Theoretical Model				Revised Model			
	U.P.C.	S.P.C.	S.E.	C.R.	U.P.C.	S.P.C.	S.E.	C.R.
Transition	1.95	.144	.785	2.48	1.951	.142	.796	2.45
Age	-.083	-.092	.053	-1.58	-.084	-.091	.055	-1.54
Gender	.844	.056	.868	.972	.944	.062	.873	1.08
Diagnosis related group	.006	.124	.003	2.14	.006	.121	.003	2.06
ICD 9 Code	-.004	-.118	.002	-2.04	-.004	-.119	.002	-2.08
Case mix index	1.40	.304	.268	5.24	1.420	.303	.278	5.10*

Note: Statistically significant @ $p \leq 0.05$. Note: U.P.C. = unstandardized path coefficients, S.P.C. = standardized path coefficients, S.E. = standard error, C. R. = critical ratios

Table 11: Goodness of Fit Statistics for Length of Stay as a Predictor of Inefficiency

Index	Criterion	Theoretical Model	Revised Model
Chi-Square (X^2)	<i>low</i>	51.195	17.573
Probability (p)	≥ 0.05	.005	.129
Degrees of freedom (df)	> 0.0	28	12
Likelihood ratio (X^2/df)	< 4.0	1.828	1.464
Goodness of fit (GFI)	$>.95$.958	.980
Adjusted GFI (AGFI)	$>.90$.932	.954
Tucker Lewis Index (TLI)	$>.90$.555	.863
Normed Fit Index (NFI)	$>.90$.503	.810
Root Mean Square Error of Approximation (RMSEA)	$\leq .05$.058	.043
Hoelter's Critical N (CN)	>200	202	298

Note: $\Delta X^2_{10} = X^2_0 - X^2_1 = 51.195 - 17.573 = 33.62 @ 16 \text{ df}$

Modeling the Cost of Services (Charges)

As costs for healthcare services are shifted from federal to state governments, a study by the Urban Institute found the state of Florida implemented new models of care and expanded Medicaid managed care to improve delivery of services. However, the value of the innovative strategies to improve efficiency and control costs has not been fully determined (Yemane & Hill, 2002).

Cost of services, represented as charges in the model, are defined by the study hospital as the gross cost of services prior to contractual allowances measured in dollars. For the purpose of this research contractual allowance reflects the difference

between cost of care and the reimbursement for services allowed under Medicare regulations and negotiated payments from third party payers.

Analytic Path Model for Charges

Figure 9 is a path model with those relationships postulated to have a direct impact depicted as standardized regression coefficients (P_{ij}). The eight exogenous indicators are transition to care facility (TCF) for rapid rehabilitation (X1), age (X2), gender (X3), DRG (X4), ICD9 (X5), case mix index (X6), hospitalist as provider (X7), and Medicare/Medicaid as payer (X8). Collectively, the eight variables explain 56% of the total variance with Case Mix Index (X6) the strongest of the predictors (71%). Transition to rapid rehabilitation (X1) provides a positive influence on the model (18%). The indicators DRG (X4) and ICD9 (X5) provide minimal influence (7% and -6% respectively). The model is within range on X^2/df (1.828), GFI (.958), AGFI (.932), RMSEA (.000), and CN (603), and slightly below the range for TLI (.871) and NFI (.808). A chi-square of 51.20 @ 28 df, a statistically significant p-value of .005, and the modification indices suggest the model may be improved through modification.

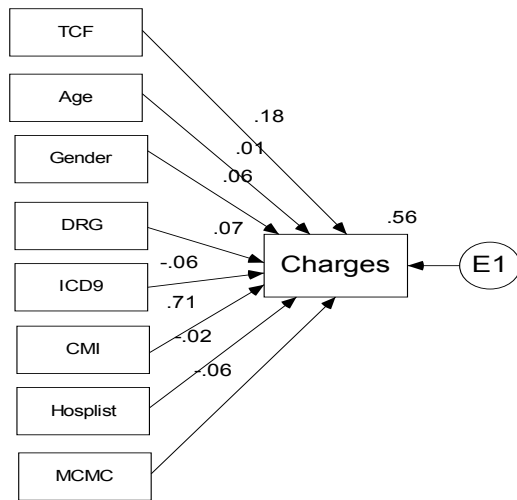

Goodness of Fit Measures (GOF)	
Chi-Square (X^2)	51.195
Probability (p)	.005
Degrees of freedom (df)	28
Likelihood ratio (X^2/df)	1.828
Goodness of fit (GFI)	.958
Adjusted GFI (AGFI)	.932
Tucker Lewis Index (TLI)	.871
Normed Fit Index (NFI)	.808
Root Mean Square Error of Approximation (RMSEA)	.000
Hoelter's Critical N (CN)	603

Note: TCF=transition to rapid rehabilitation, MCMC=Medicaid as payer

Figure 9: Analytic Path Model for Charges with GOF Measures

Modified Analytic Path Model for Charges

The direct effect of each predictor on the endogenous variable, charges (Y1) is analyzed and the model revised based on the modification indices and the goodness of fit indices (Table 13). Modification indices suggest covariance between (X1-X5), and (X1-X3), and the modified model is presented as Figure 10.

The association of DRG and ICD9 to charges contributed minimally to the path analysis model (7% and 6% respectively), and associations were eliminated in the revised model as CMI demonstrated a stronger relationship (70%) and is retained. While the association of hospitalist and Medicare-Medicaid to charges continues to contribute minimally to the development of the model (-3% and -6% respectively), the relationship of the hospitalist position in management of patient care and the

relationship of Medicare-Medicaid as a payer are of theoretical and administrative interest and are retained.

The revised analytic path model for charges (Figure 11) retains five of the original eight indicator variables, transition to care facility (TCF) for rapid rehabilitation (X1), gender (X2), case mix index (X3), hospitalist as a provider (X4), and Medicare/Medicaid as a payer (X5). The case mix index (CMI) remains the strongest of the indicators (70%), and indicates the more complex cases may be transitioned to rapid rehabilitation for further healthcare services. Transition to care facility (TCF) for rapid rehabilitation (X1) had a positive influence and contributed (17%) to the model. The covariance between (X1-X5), and (X1-X3), (-8%, 13% respectively), demonstrates that patients transitioned to rapid rehabilitation may be the most complex cases and may not qualify for Medicaid support. Collectively, the variance explained by the revised model remains 57 percent. The chi-square was reduced to 7.774 with a non-significant p-value of .456. The goodness of fit indices are within range on all estimations indicating the revised model is a better fit.

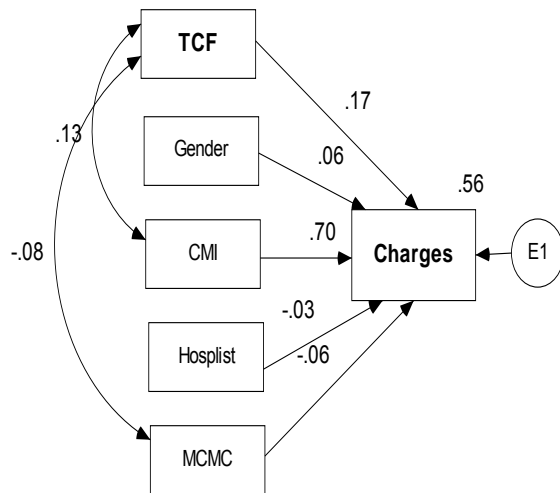

Goodness of Fit Measures (GOF)	
Chi-Square (X^2)	7.774
Probability (p)	.456
Degrees of freedom (df)	8
Likelihood ratio (X^2/df)	.972
Goodness of fit (GFI)	.989
Adjusted GFI (AGFI)	.972
Tucker Lewis Index (TLI)	1.002
Normed Fit Index (NFI)	.965
Root Mean Square Error of Approximation (RMSEA)	.000
Hoelter's Critical N (CN)	497

Note: TCF=transition to rapid rehabilitation, CMI=case mix index, MCMC=Medicaid as payer

Figure 10: Modified Analytic Path Model for Charges with GOF Measures

Analysis of Charges

Assessing the importance of the variables, finds case mix index (X3) or complexity of the case remains the strongest predictor of charges (70%), and has a critical ratio that is statistically significant ($p \leq .05$) (Table 12). The transition to a care facility (X1) providing a positive, moderate influence on the model (17%) and the critical ratio was statistically significant ($p \leq .05$) (Table 12). Age contributed minimal influence on the model (1%), and was not retained in the revised model. Indirect relationships are analyzed between variables (X1-X3) and (X1-X5). An inverse relationship is found (-8%) between TCF and Medicare/Medicaid suggesting that patients qualified for Medicaid (9%) transitioned to rapid rehabilitation less frequently than those with greater incomes (14%).

A positive relationship (13%) is found between transition to a care facility for rapid rehabilitation (X1) and case mix index (X4), suggesting that patients requiring the most complex care are utilizing the program. The hospitalist as provider (X 5) contributed minimally to the model (-3%), and the descriptive statistics indicate the intervention group (46%) and the control group (40%) were similar on this variable. The inverse relationship of the hospitalist to charges creates the possibility that hospitalist may impact cost of care positively.

The cost of care models demonstrate a chi-square difference (ΔX^2) calculated at 43.43 with 20 degrees of freedom. The indices for goodness of fit are within the recommended range on all estimated measures. The modified analytic path model for cost of care is an improved fit.

Table 12: Parameter Estimates for Cost of Care (Charges)

Variable	Theoretical Model				Revised Model			
	U.P.C	S.P.C	S.E.	C.R.	U.P.C.	S.P.C.	S.E	C.R.
Transition	15782.94	.177	3755.83	4.20	15590.98	.172	3828.27	4.07*
Gender	5683.14	.058	4154.21	1.37	6439.33	.064	4185.47	1.54
Case mix index	21754.53	.715	1282.33	16.97	21745.47	.704	1302.43	16.70*
Hospitalist	-2032.69	-.023	3723.21	-.546	-2481.08	-.028	3751.22	-.661
Medicaid	-8044.87	-.061	5582.76	-1.44	-7458.50	-.055	5642.68	-1.322

Note: Statistically significant @ $p \leq 0.05$.

Note: U.P.C. = unstandardized path coefficients, S.P.C. = standardized path coefficients, S.E. = standard error, C. R. = critical ratios

Table 13: Goodness of Fit Statistics for Charges as an Indicator of Inefficiency

Index	Criterion	Theoretical Model	Revised Model
Chi-Square (X^2)	low	51.195	7.774
Probability (p)	≥ 0.05	.005	.456
Degrees of freedom (df)	> 0.0	28	8
Likelihood ratio (X^2/df)	< 4.0	1.828	.972
Goodness of fit (GFI)	$>.95$.958	.989
Adjusted GFI (AGFI)	$>.90$.932	.972
Tucker Lewis Index (TLI)	$>.90$.871	1.002
Normed Fit Index (NFI)	$>.90$.808	.965
Root Mean Square Error of Approximation (RMSEA)	$\leq .05$.000	.000
Hoelter's Critical N (CN)	>200	603	497

Note: $\Delta X^2_{1,0} = X^2_0 - X^2_1 = 51.195 - 7.774 = 43.42$

Modeling Discharge Delays

Discharge delays are defined by the study hospital as the presence of an avoidable discharge delay from the acute care setting to home or post acute care in the community. Discharge delays may increase length of stay, cost of care, and extended hospital stays may impact the safety and functional decline of the patient (REF). The study hospital maintains a database for the information and the delays are tracked in three categories (1) hospital, (2) physician, or community. Sub-categories further define the cause of the delay, and the information is a key component of the hospital's case management process. The focus of this research includes the presence or absence of a discharge delay.

Analytic Path Model for Discharge Delays

Figure 11 is a path model with those relationships postulated to have a direct impact presented as standardized regression coefficients (P_{ij}). The eight exogenous predictor variables are transition to care facility (TCF) for rapid rehabilitation (X1), age (X2), gender (X3), DRG (X4), ICD9 (X5), case mix index (X6), hospitalist as provider (X7), and Medicare/Medicaid as payer (X8). Collectively, the eight variables explain 4% of the total variance. Hospitalist as a provider (X7) is the strongest of the indicators (16%), and ICD9 (X5) contributes a slightly smaller influence (10%). The model has a chi-square of 51.20, and a calculated p-value $\leq .005$. By all indices, the model is not adequate, and is assessed for modification.

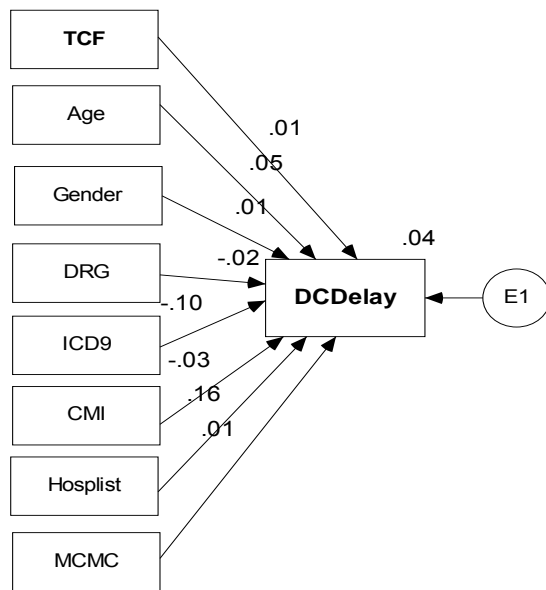

Goodness of Fit Measures (GOF)	
Chi-Square (X^2)	51.195
Probability (p)	.005
Degrees of freedom (df)	28
Likelihood ratio (X^2/df)	1.828
Goodness of fit (GFI)	.958
Adjusted GFI (AGFI)	.932
Tucker Lewis Index (TLI)	-.172
Normed Fit Index (NFI)	.167
Root Mean Square Error of Approximation (RMSEA)	.058
Hoelter's Critical N (CN)	202

Note: TCF=transition to rapid rehabilitation, CMI=case mix index, MCMC=Medicaid as payer

Figure 11: Analytic Path Model for Discharge Delays with GOF Measures

Modified Path Model for Discharge Delay

The theoretical model indicators (X1-X8) are assessed for direct and indirect effects on the latent variable, discharge delay (Y1), and revised based on modification indices and goodness of fit indices (Table 14). The association of ICD9 (X5) and hospitalist (X7) as provider contributes moderately to the path analysis model (-10% and -16% respectively). All other indicators (X1, X2, X3, X4, X6, X8) contribute minimally to the model. The revised analytic path model for discharge delays (Figure 12) retains five of the original indicator variables, transition to care facility (TCF) for rapid rehabilitation (X1), age (X2), ICD9 (X3), CMI (X4) and hospitalist as a provider (X5). Although age contributed little to the model (5%), the study is age sensitive and modification indices suggest an indirect relationship between age and case mix index, and the indicator is retained in the revised model. Collectively, the variance explained by the revised model remains at 4% with little change in the path coefficients. While goodness of fit indices are below recommended range for Normed Fit Index (NFI), remaining indices are within recommended range (Table 15).

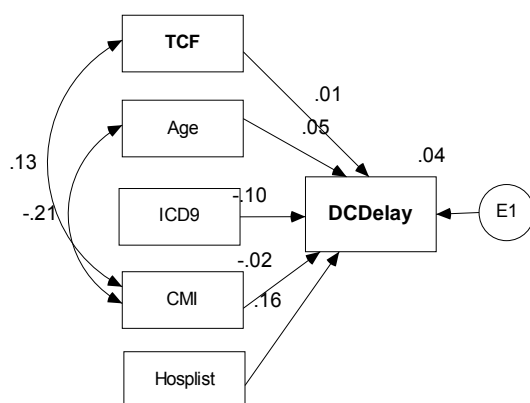

Goodness of Fit Measures (GOF)	
Chi-Square (X^2)	5.371
Probability (p)	.717
Degrees of freedom (df)	8
Likelihood ratio (X^2/df)	.671
Goodness of fit (GFI)	.993
Adjusted GFI (AGFI)	.981
Tucker Lewis Index (TLI)	1.325
Normed Fit Index (NFI)	.822
Root Mean Square Error of Approximation (RMSEA)	.000
Hoelter's Critical N (CN)	719

Note: TCF=transition to rapid rehabilitation, CMI=case mix index

Figure 12: Modified Analytic Path Model for Discharge Delays with GOF Measures

Analysis of Discharge Delay

Analysis of the revised model finds the importance of the variables to be consistent with the theoretical model. Hospitalist (X6) as provider remains the strongest indicator for discharge delay (16%), and demonstrates a critical ratio that is significant ($p \leq .05$) (Table 14). This suggests hospitalist has a positive influence on discharge delays. ICD9 (X3) has more influence (10%) than CMI (X4) (-2%) on discharge delays, meaning the unique needs and characteristics of the patient has more influence. Based on modification indices, indirect relationship between intervention (TCF) and CMI (X1-X4) is assessed, and finds a positive, indirect relationship (13%), and continues to demonstrate the more complex cases are transitioned to rapid rehabilitation. The covariance of age to CMI (X2-X4), indicates an inverse relationship (-21%) between age and complexity of case.

Collectively, variance explained by model remains at 4% and demonstrates a chi-square difference (ΔX^2) of 45.82 with 20 degrees of freedom and non-significant p-value of .717. The goodness of fit measures for the Normed Fit Index (NFI) is improved, but slightly below the recommended range. Goodness-of-fit indices are within acceptable range on all other measures. Although improved, model demonstrates limited explanatory power.

Table 14: Parameter Estimates for Discharge Delays

Variable	Theoretical Model				Revised Model			
	U.P.C	S.P.C	S.E.	C.R.	U.P.C.	S.P.C.	S.E	C.R.
Transition	.007	.013	.035	.203	.007	.012	.036	.188
Age	.002	.015	.002	.825	.002	.055	.002	.861
ICD9	.000	-.101	.000	-1.627	.000	-.105	.000	-1.690
Case mix index	-.005	-.026	.012	-.417	-.005	-.025	.012	-.383
Hospitalist	.088	.156	.035	2.511	.088	.156	.035	2.512*

Note: Statistically significant @ $p \leq 0.05$.

Note: U.P.C. = unstandardized path coefficients, S.P.C. =standardized path coefficients, S.E. = standard error, C. R. = critical ratios

Table 15: Goodness of Fit Statistics for Discharge Delay as Predictor of Inefficiency

Index	Criterion	Theoretical Model	Revised Model
Chi-Square (X^2)	<i>low</i>	51.195	5.371
Probability (p)	≥ 0.05	.005	.717
Degrees of freedom (df)	> 0.0	28	8
Likelihood ratio (X^2/df)	< 4.0	1.828	.671
Goodness of fit (GFI)	$>.95$.958	.993
Adjusted GFI (AGFI)	$>.90$.932	.981
Tucker Lewis Index (TLI)	$>.90$	-.172	1.325
Normed Fit Index (NFI)	$>.90$.167	.822
Root Mean Square Error of Approximation (RMSEA)	$\leq .05$.058	.000
Hoelter's Critical N (CN)	>200	202	719

Note: $\Delta X^2_{1-0} = X^2_0 - X^2_1 = 51.195 - 5.371 = 45.82 @ 20$ df

Analytic Path Models of Ineffectiveness

Ineffectiveness is a latent construct and in this research is utilized to represent patient-specific outcomes of transition from acute care setting to a rapid rehabilitation unit operating within a transitional care facility in community. For purpose of this research, the Baldrige National Quality Program (2006) provides a foundation for construct definition. The following indicators are meant to measure how well the rapid rehabilitation program serves to improve patient outcomes. The indicators are selected based on current and evolving measurements in literature and discussions with administrative and clinical staff of study hospital. Ineffectiveness is measured by three predictors (1) readmission to acute care within 30 days of discharge, (2) patient safety measured as falls, and (3) patient overall satisfaction. Table 16 provides a descriptive summary of predictors of latent construct, ineffectiveness.

Table 16: Descriptive Statistics for Predictors of Latent Construct Ineffectiveness

Indicator	Total Sample ^a	Group I Intervention ^b	Group II Control ^c
Readmission	50 (20%)	20 (20%)	30 (20%)
Safety (falls) ^d	16 (6.4%)	6 (6%)	10 (6.7%)
Satisfaction	Range 2.71-3.82 Mean 3.47	Range 3.00-3.82 Mean 3.47	Range 2.71-3.80 Mean 3.47

Note: ^an=250; ^bn=100; ^cn=150, ^d falls is proxy for safety

Modeling Readmissions

Readmissions for the aging population are problematic. A comprehensive review of the literature by Parker, Lee, & Fadayeatan (2006), concerning coordination of care between settings, suggests coordinating transitions between acute and post acute settings may reduce readmission rates by 17 percent. The literature defines early readmission as less than 30 days after discharge as exemplified by Timms, Parker, Fallat, & Johnson (2002). Their research documents an early readmission rate of 12.5 days, but notes there are gaps in hospital data.

For the purpose of this research, readmission is defined as readmission to hospital within 30 days of discharge from acute care setting. Outpatient or emergency department visits that do not result in documented readmission to acute care setting are not included in the research.

Analytic Path Model for Readmission

Figure 13 is a path model for readmissions with those relationships postulated to have a direct impact presented as standardized regression coefficients (P_{ij}). Eight

exogenous variables serve as indicators These are transition to care facility (TCF) for rapid rehabilitation (X1), age (X2), gender (X3), DRG (X4), ICD9 (X5), case mix index (X6), hospitalist as provider (X7), and Medicaid as payer (X8).

Collectively, eight variables explain 4% of total variance with case mix index (X6) the strongest of the indicators (-15%). Transition to rapid rehabilitation (X1) contributes a positive, but minimal influence on the variance (3%). Indicators DRG (X4) and Medicare/Medicaid (X8) provide a slight influence (-7% and 8% respectively) and ICD9 (X5) and hospitalist (X7) contributes minimal influence (-3%).

Goodness-of-fit indices for model are below recommended criterion for Tucker Lewis Index (TLI), Normed Fit Index (NFI), and the root mean square error of approximation (RMSEA). Measures for likelihood ration (X^2/df), goodness of fit (GFI), adjusted goodness of fit (AGFI), and Hoelter's Critical N (CN) are within range. The model demonstrates a chi-square of 51.20 and a statistically significant p-value of .005. Based on these measures, the model is inadequate, and is assessed for modification.

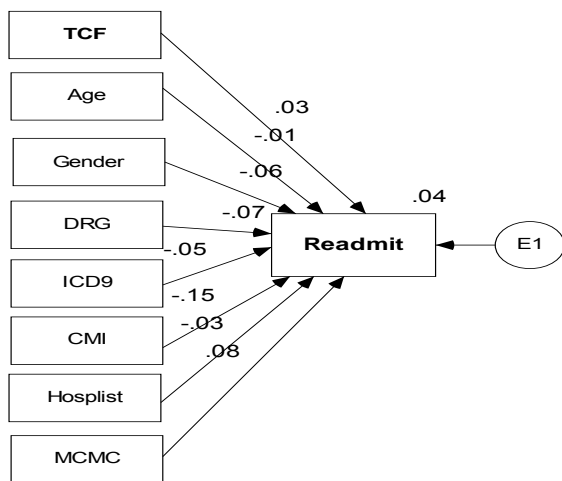

Goodness of Fit Measures (GOF)	
Chi-Square (X^2)	51.195
Probability (p)	.005
Degrees of freedom (df)	28
Likelihood ratio (X^2/df)	1.828
Goodness of fit (GFI)	.958
Adjusted GFI (AGFI)	.932
Tucker Lewis Index (TLI)	-.172
Normed Fit Index (NFI)	.167
Root Mean Square Error of Approximation (RMSEA)	.058
Hoelter's Critical N (CN)	202

Note: TCF=transition to rapid rehabilitation, CMI=case mix index

Figure 13: Analytic Path Model for Readmissions with GOF Measures

Modified Path Model for Readmissions

The theoretical model indicators (X1-X8) are assessed for direct and indirect effects on latent variable, discharge delay (Y1), and revised based on the modification indices and the goodness of fit indices (Table 18). Case mix index (X6) contributes strongest relationship to the model (-15%). Medicare/Medicaid (X8) contributes (8%). All other indicators (X1, X2, X3, X4, X5, and X7) contribute minimally to the model. The revised analytic path model for readmissions (Figure 14) retains six of original eight indicator variables, transition to care facility (TCF) for rapid rehabilitation (X1), gender (X2), DRG(X3), ICD9 (X4), CMI (X5) and Medicare/Medicaid (X6).

Collectively, variance explained by revised model remains at .4% with little change in path coefficients. The revised model is slightly below recommended range for the Normed Fit Index (NFI), and is improved for all other goodness of fit measures.

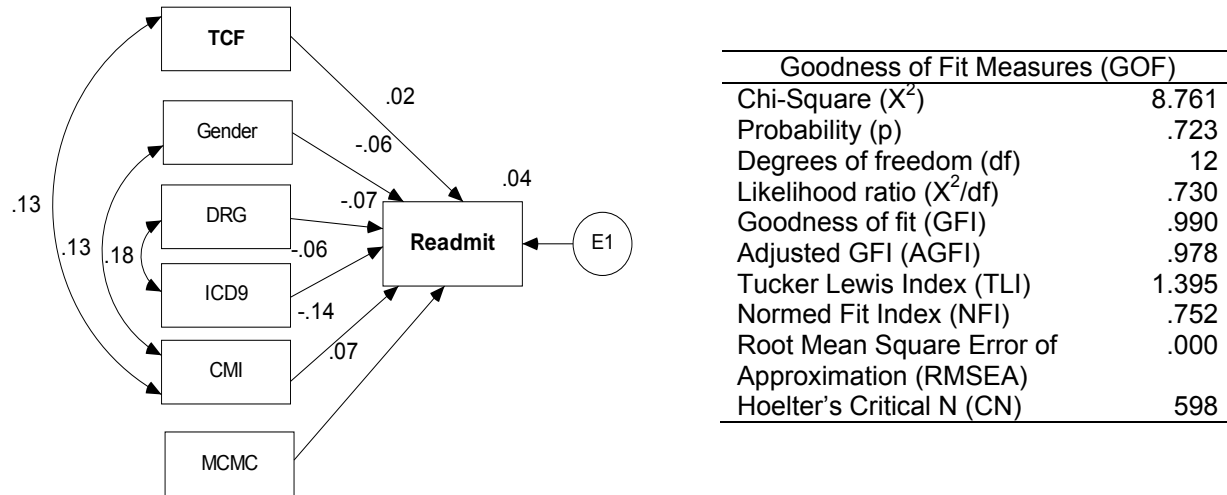

Note: TCF=transition to rapid rehabilitation, CMI=case mix index

Figure 14: Modified Analytic Path Model for Readmissions with GOF Measures

Analysis of Readmissions Model

Analysis of revised model finds importance of variables to be consistent with theoretical model. Case mix index (X5) remains strongest indicator for readmissions (-14%), and demonstrates a critical ratio that is statistically significant ($p \leq .05$) (Table 17). Medicaid as a payer contributes (7%), and suggests patients with fewer resources may be readmitted more frequently. Based on modification indices, the indirect relationship between transition (TCF) and CMI (X1-X5) is assessed, and finds a positive, indirect relationship (13%). This is consistent with other models suggesting

more complex cases are transitioned to rapid rehabilitation. The covariance of gender to CMI (X2-X5), finds a positive, indirect relationship (13%). As expected, the relationship between DRG (X3) and ICD9 (X4) (18%) is positive.

Collectively, the variance explained by model remains at 4%. The model demonstrates a chi-square difference (ΔX^2) of 42.34 @ 16df and non-significant p-value of .723. The goodness of fit measure for Normed Fit Index (NFI) is improved, but remains slightly below recommended range. The remaining goodness of fit measures are within the recommended range on all measures. Although improved, the model demonstrates limited explanatory power for readmission.

Table 17: Parameter Estimates for Readmission

Variable	Theoretical Model				Revised Model			
	U.P.C	S.P.C	S.E.	C.R.	U.P.C.	S.P.C.	S.E	C.R.
Transition	.020	.025	.051	.403	.019	.023	.051	.368
Gender	-.052	-.058	.056	-.934	-.052	-.058	.057	-.928
DRG	.000	-.068	.000	-1.089	.000	-.066	.000	-1.042
ICD9	.000	-.054	.000	-.873	.000	-.056	.000	-.891
Case mix index	-.040	-.145	.017	-2.338	-.040	-.143	.018	-2.258*
Medicaid	.091	.075	.075	1.208	.091	.075	.075	1.205

Note: Statistically significant @ $p \leq 0.05$.

Note: U.P.C. = unstandardized path coefficients, S.P.C. = standardized path coefficients, S.E. = standard error, C. R. = critical ratios

Table 18: Goodness of Fit Statistics for Readmission as an Indicator of Ineffectiveness

<i>Index</i>	<i>Criterion</i>	<i>Theoretical Model</i>	<i>Revised Model</i>
Chi-Square (X^2)	<i>low</i>	51.195	8.761
Probability (p)	≥ 0.05	.005	.723
Degrees of freedom (df)	> 0.0	28	12
Likelihood ratio (X^2/df)	< 4.0	1.828	.730
Goodness of fit (GFI)	$> .95$.958	.990
Adjusted GFI (AGFI)	$> .90$.932	.978
Tucker Lewis Index (TLI)	$> .90$	-.172	1.395
Normed Fit Index (NFI)	$> .90$.167	.752
Root Mean Square Error of Approximation (RMSEA)	$\leq .05$.058	.000
Hoelter's Critical N (CN)	> 200	202	598

Note: $\Delta X^2_{1-0} = X^2_o - X^2_1 = 51.195 - 8.761 = 42.434 @ 16 \text{ df}$

Modeling Safety (Falls)

Patient safety continues to be a concern of all stakeholders. The Joint Commission on the Accreditation of Hospitals (2007) is approving new safety requirements for hospitals that include goals for patient hand offs, and accuracy of hospital information. For this research, patient safety is measured by proxy patient falls rather than all adverse patient events. This decision was based on availability of objective data to document fall events, and potential for other adverse events to be confounded by subjective reporting format. Patient falls are defined as any fall occurring during the care experience in acute care setting.

Analytic Path Model for Safety

Figure 15 is a path model for safety with those relationships postulated to have direct impact presented as standardized regression coefficients (P_{ij}). The eight exogenous predictor variables are transition to care facility (TCF) for rapid rehabilitation (X1), age (X2), gender (X3), DRG (X4), ICD9 (X5), case mix index (X6), hospitalist as provider (X7), and Medicare/Medicaid as payer (X8).

Collectively, eight variables explain 2% of total variance. ICD9 (X5) is strongest of indicators (-13%). All other indicators (X1, X2, X3, X4, X6, X7 and X8) contribute minimally to model. The goodness of fit measures are below recommended range for Tucker Lewis Index (TLI), Normed Fit Index (NFI), and the root mean square of approximation (RMSEA). The model has a chi-square of 51.20, and calculated p-value of .005. Therefore, the model is not adequate, and is assessed for modification.

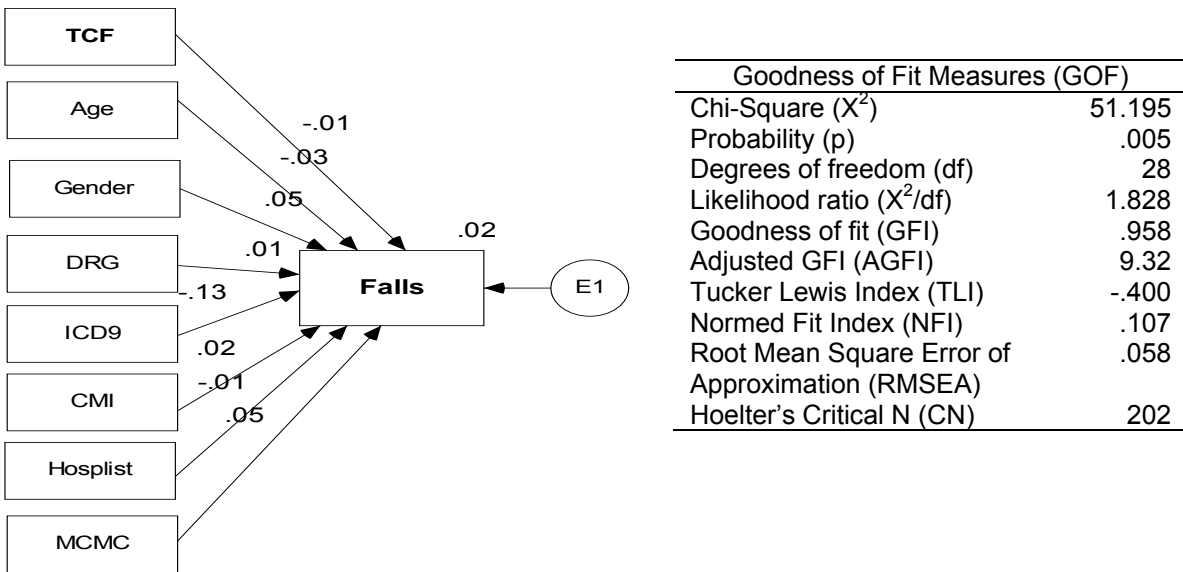

Note: TCF=transition to rapid rehabilitation, CMI=case mix index, MCMC=Medicaid as payer

Figure 15: Analytic Path Model for Safety (Falls) with GOF Measures

Modified Analytic Path Model for Safety

The theoretical model indicators (X1-X8) are assessed for direct and indirect effects on latent variable, safety (Y1), and revised based on the modification and goodness of fit indices (Table 20). The revised analytic path model for patient safety (Figure 16) retains six of the original eight indicators, transition to care facility (TCF) for rapid rehabilitation (X1), age (X2), Gender (X3), ICD9 (X4) CMI (X5) and Medicare/Medicaid (X5). ICD9 (X4) is consistent with the theoretical model, and exhibits the strongest contribution to the model (-12%). All other indicators (X1, X2, X3, X5, and X6) contribute minimally to the model. Although age contributes little to the model (1%),

the study is age sensitive and modification indices suggest an indirect relationship between age and case mix index, and indicator is retained. in revised model.

Collectively, variance explained by revised model remains at 2% with little change in path coefficients. Based on goodness of fit indices, Normed Fit Index (NFI) is slightly below recommended range. The model is in range on all other goodness of fit measures,

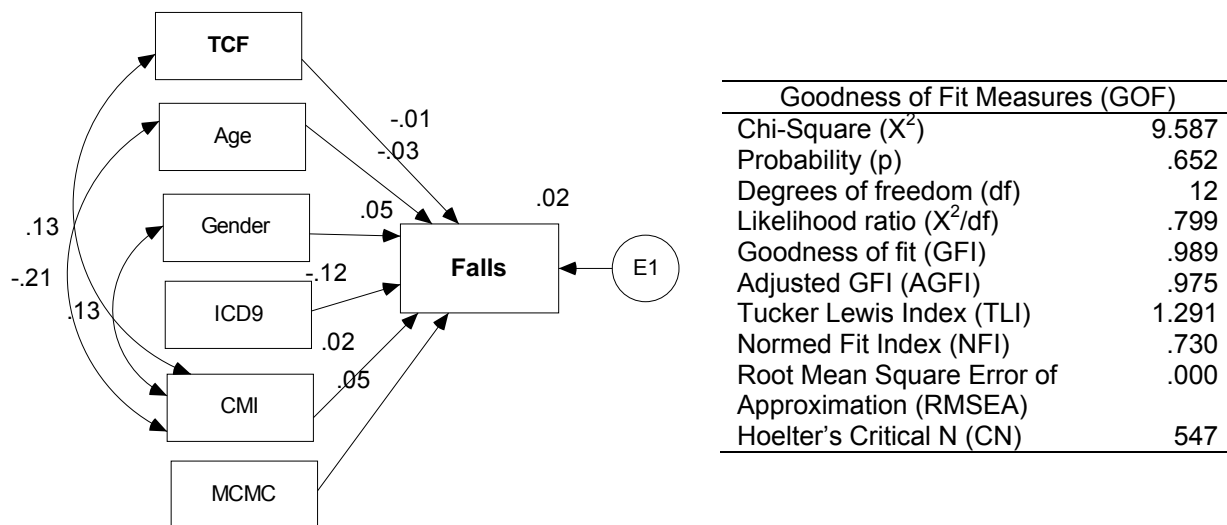

Note: TCF=transition to rapid rehabilitation, CMI=case mix index, MCMC=Medicaid as payer

Figure 16: Modified Analytic Path Model for Safety (Falls) with GOF Measures

Analysis of Safety (Falls)

Analysis of revised model finds path coefficients to be consistent with theoretical model. ICD9 (X4) has an inverse relationship (-12%) to patient falls and suggest there is a relationship between falls and the unique needs and characteristics of patient. In

addition, ICD9 (X4) demonstrates a critical ratio that is statistically significant ($p \leq .05$). Based on modification indices, covariance TCF (X1) and the CMI (X1-X5) finds a positive relationship (13%) and is consistent with other models. The covariance of age to CMI (X2-X4), finds a moderate, inverse relationship (-21%), and the covariance between gender (X3) and CMI (X5) is positive (13%).

Collectively, the variance explained by model remains at 2%. The chi-square difference (ΔX^2) of 41.61 @ 16 df and non-significant p-value of .652 suggest the model is improved. Although improved based on goodness of fit indices, model demonstrates limited explanatory power for safety/falls.

Table 19: Parameter Estimates for Safety (Falls)

Variable	Theoretical Model				Revised Model			
	U.P.C	S.P.C	S.E.	C.R.	U.P.C.	S.P.C.	S.E	C.R.
Transition	-.005	-.010	.031	-.157	-.005	.024	.032	-.173
Age	-.001	-.026	.002	-.410	-.001	-.028	.002	-.441
Gender	.028	.051	.035	.819	.029	.052	.035	.821
ICD9	.000	-.126	.000	-2.008	.000	-.125	.000	-1.989*
Case mix index	.004	.024	.011	.383	.004	.024	.011	.363
Medicaid	.037	.050	.046	.803	.038	.051	.046	.808

Note: Statistically significant @ $p \leq 0.05$.

Note: U.P.C. = unstandardized path coefficients, S.P.C. = standardized path coefficients, S.E. = standard error, C. R. = critical ratios

Table 20: Goodness of Fit Statistics for Safety (Falls) as Indicator of Ineffectiveness

Index	Criterion	Theoretical Model	Revised Model
Chi-Square (X^2)	<i>low</i>	51.195	9.587
Probability (p)	≥ 0.05	.005	.652
Degrees of freedom (df)	> 0.0	28	12
Likelihood ratio (X^2/df)	< 4.0	1.828	.799
Goodness of fit (GFI)	$> .95$.958	.989
Adjusted GFI (AGFI)	$> .90$	9.32	.975
Tucker Lewis Index (TLI)	$> .90$	-.400	1.291
Normed Fit Index (NFI)	$> .90$.107	.730
Root Mean Square Error of Approximation (RMSEA)	$\leq .05$.058	.000
Hoelter's Critical N (CN)	> 200	202	547

$\Delta X^2_{1-0} = X^2_0 - X^2_1 = 51.195 - 9.587 = 41.61 @ 16 \text{ df}$

Modeling Patient Satisfaction

Patient satisfaction was the most problematic of indicators to abstract from two potential data sources. In this hospital setting, patients opting for rapid rehabilitation may receive a satisfaction survey about their experience. However, origin, validity and reliability of instrument could not be verified, and administration of survey during study year of 2005 was inconsistent, meaning data is incomplete and subjective, and not a viable data resource. The hospital participates in an ongoing patient satisfaction survey administrated by the Gallup organization. In this survey all patients have potential to be randomly selected. They are contacted 2-4 weeks after discharge and asked to respond

to a set of 25 questions to quantify satisfaction with an array of services, and experiences.

For this research, hospital administration provided data to be abstracted for overall satisfaction and stratified data to abstract only those patients in population ≥ 65 . Because the survey is confidential, data for this variable is collected at unit level for time patient is on the unit, and defined as overall satisfaction with care.

Analytic Path Model for Satisfaction

Figure 17 is a path model with those relationships postulated to have a direct impact presented as standardized regression coefficients (P_{ij}). The eight exogenous predictor variables are transition to care facility (TCF) for rapid rehabilitation (X1), age (X2), gender (X3), DRG (X4), ICD9 (X5), case mix index (X6), hospitalist as provider (X7), and Medicare/Medicaid as payer (X8). Collectively, eight variables explain 3% of total variance. ICD9 (X5) is the strongest of the indicators (-11%). All other indicators (X1, X2, X3, X4, X6, X7 and X8) contribute minimally to model. The goodness of fit measures are below recommended range for Tucker Lewis Index (TLI), Normed Fit Index (NFI), and root mean square error of approximation (RMSEA). The model demonstrates a chi-square of 51.20, and a calculated p-value of .005. The model is not adequate, and therefore is assessed for modification.

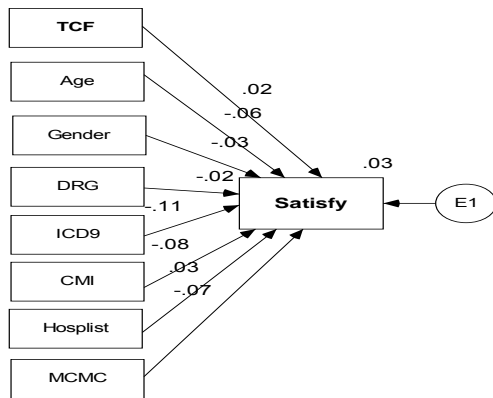

Goodness of Fit Measures (GOF)	
Chi-Square (X^2)	51.195
Probability (p)	.005
Degrees of freedom (df)	28
Likelihood ratio (X^2/df)	1.828
Goodness of fit (GFI)	.958
Adjusted GFI (AGFI)	.932
Tucker Lewis Index (TLI)	-.405
Normed Fit Index (NFI)	.105
Root Mean Square Error of Approximation (RMSEA)	.058
Hoelter's Critical N (CN)	202

Note: TCF=transition to rapid rehabilitation, CMI=case mix index, MCMC=Medicaid as payer

Figure 17: Analytic Path Model for Satisfaction with GOF Measures

Modification of Analytic Path Model for Satisfaction

The theoretical model indicators (X1-X8) are assessed for direct and indirect effects on the latent variable, satisfaction (Y1), and revised based on modification indices and goodness of fit indices (Table 22). The revised analytic path model for patient satisfaction (Figure 18) retains six of the original eight indicators, transition to care facility (TCF) for rapid rehabilitation (X1), age (X2), gender (X3), ICD9 (X4) CMI (X5) and Medicare/Medicaid (X5). ICD9 (X4) continues to exhibit the strongest contribution to the model (-11%). All other indicators (X1, X2, X3, X5, and X6) contribute minimally to the model. Collectively, variance explained by revised model remains at 2% with little change in path coefficients. The revised model is in range on all goodness of fit indices, with the exception of the Normed Fit Index (NFI) which remains slightly below recommended measures. The indices indicate revised model is improved, but has limited explanatory power.

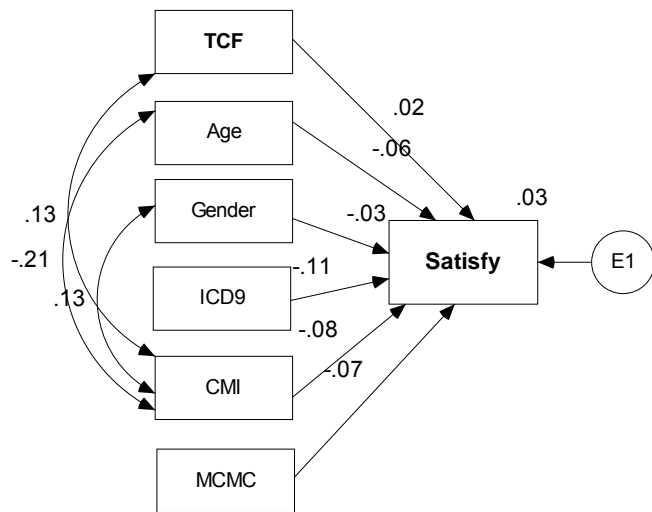

Goodness of Fit Measures (GOF)	
Chi-Square (X^2)	9.587
Probability (p)	.652
Degrees of freedom (df)	12
Likelihood ratio (X^2/df)	.799
Goodness of fit (GFI)	.989
Adjusted GFI (AGFI)	.975
Tucker Lewis Index (TLI)	1.297
Normed Fit Index (NFI)	.728
Root Mean Square Error of Approximation (RMSEA)	.000
Hoelter's Critical N (CN)	547

Note: TCF=transition to rapid rehabilitation, CMI=case mix index, MCMC=Medicaid as payer

Figure 18: Modified Analytic Path Model for Satisfaction with GOF Measures

Analysis of Satisfaction

Analysis of revised model finds the path coefficients to be consistent with the theoretical model. ICD9 (X4) has an inverse relationship (-11%) to patient satisfaction with a critical ratio that is not significant. This is consistent with the theoretical model and suggest there is a relationship between satisfaction and the unique characteristics of the case. Based on the modification indices, the covariance TCF (X1) and CMI (X1-X5) finds a positive, indirect relationship (13%). The covariance of age to CMI (X2-X4), finds a moderate, inverse relationship (-21%), and the covariance between gender (x3) and CMI (X5) is positive (13%).

Collectively, the variance explained by the model remains at 2%. The chi-square difference of 41.61 @ 16 df and non-significant p-value of .652 suggest the model is

improved. Although improved based on goodness of fit measures, the model demonstrates limited explanatory power for patient satisfaction.

Table 21: Parameter Estimates for Dissatisfaction

Variable	Theoretical Model				Revised Model			
	U.P.C	S.P.C	S.E.	C.R.	U.P.C.	S.P.C.	S.E	C.R.
Transition	.006	.016	.025	.264	.007		.025	.298
Gender	-.013	-.031	.027	-.489	-.014		.027	-.500
ICD9	.000	-.109	.000	-1.742	.000		.000	-1.750
Case mix index	-.011	.029	.008	-1.318	-.011		.009	-1.266
Medicaid	-.040	-.068	.036	-1.091	-.040		.037	-1.097

Note: Statistically significant @ $p \leq 0.05$.

Note: U.P.C. = unstandardized path coefficients, S.P.C. = standardized path coefficients, S.E. = standard error, C. R. = critical ratios

Table 22: Goodness of Fit Statistics for Dissatisfaction as Indicator of Ineffectiveness

Index	Criterion	Theoretical Model	Revised Model
Chi-Square (X^2)	low	51.195	9.587
Probability (p)	≥ 0.05	.005	.652
Degrees of freedom (df)	> 0.0	28	12
Likelihood ratio (X^2/df)	< 4.0	1.828	.799
Goodness of fit (GFI)	$>.95$.958	.989
Adjusted GFI (AGFI)	$>.90$.932	.975
Tucker Lewis Index (TLI)	$>.90$	-.405	1.297
Normed Fit Index (NFI)	$>.90$.105	.728
Root Mean Square Error of Approximation (RMSEA)	$\leq .05$.058	.000
Hoelter's Critical N (CN)	>200	202	547

Note: $\Delta X^2_{1-0} = X^2_0 - X^2_1 = 51.195 - 9.587 = 41.61$ @ 16 df

Strategic Framework for Model Generating

The analytic path diagrams for the study provide a visual depiction of casual relationships theoretically thought to impact efficiency and effectiveness of healthcare transitions. As expected, fit between the hypothesized models and observed data is not perfect and a differential was found to be present in all analytic path models. The model fitting process provides for a number of ways to approach the differential or residuals and the study proceeds with modification and reestimation of the conceptual model based on this process for model generating (Byrne, 2001):

$$\text{Data} = \text{Model} + \text{Residual}$$

Structural Models

The analytic path models demonstrate limited explanatory power, and two steps are taken to generate the final structural model and to reflect the inverse relationship described in the conceptual framework: (1) unobserved latent variables of efficiency of processes (Y1) and effectiveness of outcomes (Y2) presented in conceptual measurement model are modified to be an observed latent variable, healthcare transition to rapid rehabilitation (X1); (2) satisfaction was modified and recalculated as dissatisfaction (Figure 19).

Proposed Structural Model

The structural model with directly observed latent variable, transition to rapid rehabilitation (X1) encompasses six exogenous predictor variables (Figure 19) length of

stay (Y1), charges (Y2), discharge delays (Y3), readmissions (Y4), patient safety (Y5), and patient dissatisfaction (Y6).

There is a positive relationship between transition to rapid rehabilitation (TCF) and length of stay (17%) and TCF and Charges (26%). Relationships among remaining coefficients are positive between length of stay and dissatisfaction (11%), between charges and falls (9%), and between charges and dissatisfaction (12%), and between discharge delays and falls, (12%). All other indicators contribute minimally to model. The model has a chi-square of 177.60, and a calculated p-value of .000, and is out of range on the goodness of fit indices. The proposed model is not adequate, and is revised based on modification indices.

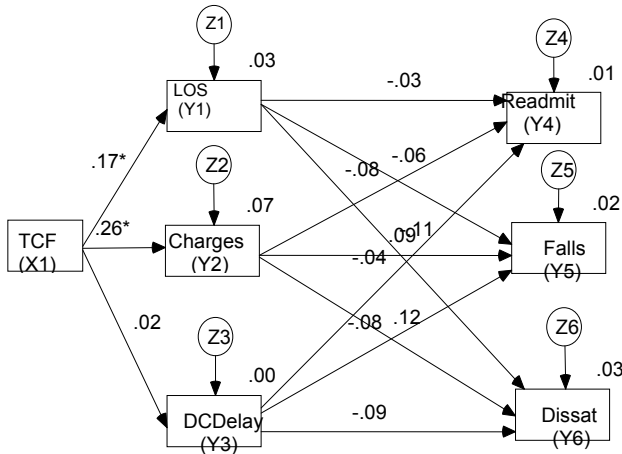

Goodness of Fit Measures (GOF)	
Chi-Square (X^2)	177.595
Probability (p)	.000
Degrees of freedom (df)	9
Likelihood ratio (X^2/df)	19.733
Goodness of fit (GFI)	.868
Adjusted GFI (AGFI)	.589
Tucker Lewis Index (TLI)	-1.047
Normed Fit Index (NFI)	.167
Root Mean Square Error of Approximation (RMSEA)	.274
Hoelter's Critical N (CN)	24

Note: * Statistically significant at the 0.05 or lower level

Note: TCF= transition to rapid rehabilitation, LOS=length of stay, Readmit=readmission, DCDelay= discharge delay, Dissat=dissatisfaction

Figure 19: Proposed Structural Model with GOF Measures

Modified Structural Model

The modified structural model is presented in Figure 20. The model is composed of five predictor variables, length of stay (Y1), charges (Y2), readmission (Y3), Safety/falls (Y4), and dissatisfaction (Y5). The indicator discharge delay did not contribute to the proposed model (0%) and was not retained. Modification indices suggested covariance between (z1-z2) and (z4 and z5). The indicator safety/falls contributes minimally to proposed model, but is retained to explore covariance suggested by modification indices. The path coefficients between transition to rapid rehabilitation and length of stay (17%) and between transition to rapid rehabilitation and charges (26%) are positive. This suggests that patients with increased length of stay and increased charges in the acute care setting are transitioned to the rapid rehabilitation unit. There is a positive covariance (70%) between LOS and charges (z1-z2). All factors contributing to the covariance are unknown, but the highly correlated terms demonstrate the strong relationship between LOS and cost of care.

Overall, the model is improved. The chi-square was reduced to 4.00 and the p-value is ≥ 0.05 . The critical ratio for transition to rapid rehabilitation has a statistically significant ($p \leq .05$) relationship to cost of care, termed charges in the model. The model is within the recommended range for all estimations on all goodness of fit indices. However, the indicator dissatisfaction contributes little to the revised model (1%), and a final modification was explored.

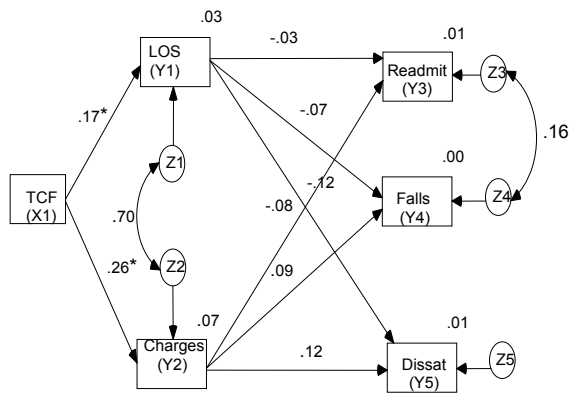

Goodness of Fit Measures (GOF)	
Chi-Square (X^2)	4.001
Probability (p)	.549
Degrees of freedom (df)	5
Likelihood ratio (X^2/df)	.800
Goodness of fit (GFI)	.995
Adjusted GFI (AGFI)	.978
Tucker Lewis Index (TLI)	1.015
Normed Fit Index (NFI)	.981
Root Mean Square Error of Approximation (RMSEA)	.000
Hoelter's Critical N (CN)	689

Note: * Statistically significant at the 0.05 or lower level

Note: TCF= transition to rapid rehabilitation, LOS=length of stay, Readmit=readmission, Dissat=dissatisfaction

Figure 20: Modified Structural Model with GOF Measures

Final Analysis of the Structural Model

The final model generated for study is presented as Figure 21. The model is composed of four predictor variables, length of stay (Y1), charges (Y2), readmission (Y3), and safety/falls (Y4). The indicator dissatisfaction did not contribute to the modified model (Figure 20) and is not retained in the final model. The final structural model generated for the study improves from the modified model (Figure 20). The chi-square is reduced to .430 and the p-value is ≥ 0.05 with a difference (ΔX^2) in chi-square computed to be 177.17. The goodness of fit indices are within the recommended range for all estimations. In the final analysis, two of the original six predictors have statistically significant critical ratios ($p \leq .05$); length of stay (Y1) and cost of care, termed charges (Y2), are statistically significant and contribute positively to the model. The remaining proposed indicators, discharge delays, readmission within 30 days of discharge, and

patient dissatisfaction contributed minimally to model and have limited explanatory power.

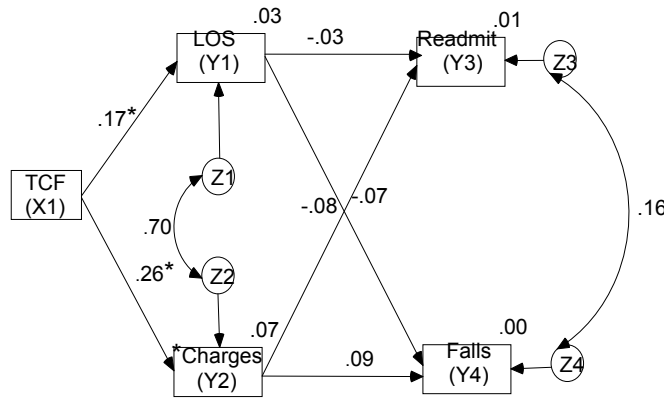

Goodness of Fit Measures (GOF)	
Chi-Square (X^2)	2.987
Probability (p)	.394
Degrees of freedom (df)	3
Likelihood ratio (X^2/df)	.996
Goodness of fit (GFI)	.995
Adjusted GFI (AGFI)	.977
Tucker Lewis Index (TLI)	1.000
Normed Fit Index (NFI)	.985
Root Mean Square Error of Approximation (RMSEA)	.000
Hoelter's Critical N (CN)	652

Note: * Statistically significant at the 0.05 or lower level

Note: TCF= transition, LOS=length of stay, Readmit=readmission, Dissat=dissatisfaction

Figure 21: Final Structural Model with GOF Measures

Table 23: Parameter Estimates for Generated Structural Models

Indicator	Theoretical Model				Final Structural Model			
	U.P.C	S.P.C	S.E.	C.R.	U.P.C.	S.P.C.	S.E	C.R.
los ← TCF	2.403	.175	.858	2.802*	2.403	.175	.858	2.802*
charges ← TCF	24122.69	.264	5579.24	4.324*	24122.69	.264	5579.24	4.324*
dcdelay ← TCF	.010	.018	.036	.279				
falls ← los	-.002	-.064	.002	-1.016	-.003	-.070	.003	-.781
readmit ← charges	.000	-.083	.000	-1.320	.000		.000	-.916
falls ← dcdelay	-.069	-.077	.056	-1.232				
readmit ← dcdelay	-.057	-.040	.091	-.632				
readmit ← los	-.002	-.027	.004	-.428	.000	-.030	.005	-.336
dissat ← dcdelay	-.005	-.088	.004	-1.411				
dissat ← charges	.000	.117	.000	1.873				
dissat ← los	.000	-.110	.000	.000				
falls ← charges	.000	.087	.000	-1.766	.000	.90	.000	1.000
z1 ↔ z2					199829.52	.699	22107.67	9.039*
z3 ↔ z4					.016	.160	.006	2.486

Note: * Statistically significant at the 0.05 or lower level

Note: U.P.C. = unstandardized path coefficients, S.P.C. =standardized path coefficients, S.E. = standard error, C. R. = critical ratios

Table 24: Goodness of Fit Statistics for Generated Structural Models

Index	Criterion	Theoretical Model	Revised Model	Final Model
Chi-Square (X^2)	<i>low</i>	177.60	4.00	.430
Probability (p)	≥ 0.05	.000	.549	.806
Degrees of freedom (df)	> 0.0	9	5	2
Likelihood ratio (X^2/df)	< 4.0	19.73	.800	.215
Goodness of fit (GFI)	$> .95$.868	.995	.999
Adjusted GFI (AGFI)	$> .90$.589	.978	.995
Tucker Lewis Index (TLI)	$> .90$	-1.05	1.02	1.041
Normed Fit Index (NFI)	$> .90$.167	.981	.998
Root Mean Square Error of Approximation (RMSEA)	$\leq .05$.274	.000	.000
Hoelter's Critical N (CN)	> 200	24	689	3468

Note: $\Delta X^2_{1-0} = X^2_o - X^2_i = 177.60 - 2.99 = 174.61$ @ 6 df

Hypotheses

Three research hypotheses are proposed regarding the analytic path models for healthcare transitions to rapid rehabilitation for the aging population and these are summarized in Table 25.

H1: Holding constant the patient and facility characteristics, transition to rapid rehabilitation has an inverse relationship to the predictors for inefficient delivery of healthcare services to the aging patient.

1a: Holding constant the patient and facility characteristics, transition to rapid rehabilitation has an inverse relationship with length of stay.

1b: Holding constant the patient and facility characteristics, transition to rapid rehabilitation has an inverse relationship with hospital charges.

1c: Holding constant the patient and facility characteristics, transition to rapid rehabilitation has an inverse relationship with discharge delays.

H1, H1a, H1b, H1c are not supported. Transition to rapid rehabilitation (TCF) is positively correlated to length of stay (.17) and to hospital charges before contractual allowances (.26). This suggests that patients transitioned to rapid rehabilitation may be the most complex, have the longest length of stay and be the most costly for the healthcare system. While not well supported by the data, H1c regarding discharge delays was slightly correlated (.02) to healthcare transition (TCF) suggesting that patients transitioned to rapid rehabilitation may experience discharge delay. This may be related to the case complexity demonstrated by the intervention study sample. Based on the explanatory power for efficiency, the researcher fails to reject the null.

H2: Holding constant the patient and facility characteristics, transition to rapid rehabilitation has an inverse relationship with the predictors of ineffective delivery of healthcare services to the aging patient.

2a: Holding constant the patient and facility characteristics, transition to rapid rehabilitation has an inverse relationship with readmissions.

2b: Holding constant the patient and facility characteristics, transition to rapid rehabilitation has an inverse relationship with patient safety.

2c: Holding constant the patient and facility characteristics, transition to rapid rehabilitation has an inverse relationship with patient dissatisfaction.

H2, H2a, H2b, and H2c are not supported. The relationship between transition to rapid rehabilitation (TCF) and readmissions, patient falls, and patient dissatisfaction was minimal. Essentially very little relationship was noted between the intervention and

control groups suggesting that transition to rapid rehabilitation made very little difference when measured by the proposed predictors. Based on the limited explanatory power for effectiveness, the research fails to reject the null.

Ha 3: Holding constant the patient and facility characteristics, transition to rapid rehabilitation has an inverse relationship with the predictors for inefficient and ineffective healthcare transitions when delivering healthcare services to the aging patient. The relationships are not inverse, and the model demonstrated minimal explanatory power for measuring inefficiency and in effectiveness at the patient level.

Table 25: Summary of Hypotheses and Testing

Hypotheses	Projected Findings	Actual Findings
H1: Healthcare transition to efficiency	Inverse relationship	Not inverse
H1a:Healthcare transition to length of stay	Inverse relationship	Not inverse*
H1b:Healthcare transition to cost of care	Inverse relationship	Not inverse*
H1c:Healthcare transition to discharge delay	Inverse relationship	Not statistically significant
H2: Healthcare transition to effectiveness:	Inverse relationship	Not statistically significant
H2a:Healthcare transition to readmissions	Inverse relationship	Not statistically significant
H2b:Healthcare transition to safety/falls	Inverse relationship	Not statistically significant
H2c:Healthcare transition to dissatisfaction :	Inverse relationship	Not statistically significant
H3: Healthcare transition to efficiency and effectiveness	Inverse relationship	Not statistically significant
Note: * Statistically significant at $p \leq 0.05$		

Statistical Relationships, Unexpected Outcomes

The intervention for this research, rapid rehabilitation, has been found to be an effective, efficient, and safe alternative to more traditional rehabilitation models across a broad spectrum of diagnoses and procedures (Berger et al 2004, Bardram, Funch, & Kehlet, 2000). The literature finds that multimodal rehabilitation has the potential to optimize discharge from the acute care setting and return patients to an optimal level of function earlier in the continuum of care than would be expected if these services are not available (Berger et al 2004, Bardram, Funch, & Kehlet, 2000). However, findings from this research yield statistical relationships and outcomes that are unexpected. The findings suggest that successful implementation and utilization of rapid rehabilitation as a delivery model are dependent on factors outside this research and may include hospital and clinical leadership and structure of the environment of care.

The researcher projected an inverse relationship between the intervention, transition to rapid rehabilitation, and the selected indicators for inefficiency of hospital processes and ineffectiveness of patient outcomes. This means that patient length of stay, cost of care, discharge delays, readmission rates, falls, and dissatisfaction would decrease for those patients transitioned to rapid rehabilitation. In fact, the study finds the projected inverse relationship is not true for 3 of 6 indicators, and not statistically significant for 3 indicators (Table 25). Interestingly, positive, and statistically significant relationships were found in 2 of the 6 indicators, length of stay, and cost of care.

Length of Stay

LOS was projected to decrease as intervention of rapid rehabilitation increased, meaning an inverse relationship would be present. In fact, the opposite is found to be true. The relationship between the intervention, transition to rapid rehabilitation and length of stay has a positive path coefficient (.17) and is statistically significant at 0.05 or lower level. The intervention group has a mean LOS of (9.17) that is higher than control group (6.77) by 2.44 days.

Cost of Care

An unexpected outcome is found for the indicator for cost of care as well. Termed charges in the structural model, costs were projected to decrease as intervention of rapid rehabilitation increased, meaning an inverse relationship would be present. In fact, the opposite is found to be true. The relationship between the intervention, transition to rapid rehabilitation and charges has a positive path coefficient (.26) and is statistically significant at 0.05 or lower level. The mean charges for the intervention group (57,846) are higher than the control group (33,723) by a cost of \$24,123.

Discharge Delays

Providing early discharge to a community-based facility owned by the hospital for rapid rehabilitation was projected to decrease discharge delays, meaning an inverse relationship would exist between the intervention and indicator. Descriptive statistics find this to be true, but with an unexpected minimal difference (1%). The intervention group has mean discharge delays (9 delays for 100 patients) that are less than control

group (12 delays for 150 patients). The indicator contributed minimally to structural model, has limited explanatory power and is not retained in final structural model.

Readmission Rates

Theoretically, readmission rates were projected to decrease for the intervention group, meaning there an inverse relationship would exist. However, descriptive statistics finds no difference between the groups for this indicator. The intervention group has mean readmission rate (20 readmissions for 100 patients) that are the same (20%) for the control group (30 readmissions for 150 patients). The indicator contributes minimally to model (.01), but the negative mediated path coefficient (-.03) between LOS and readmission rates, suggests readmission to acute care may decrease as length of stay increases for the initial hospital stay.

Patient Falls

In this study, patient falls serve as the proxy for safety. In the study model, patients are transitioned to rapid rehabilitation as a means to provide for an earlier discharge from the acute care setting. An inverse relationship was projected to exist between the intervention and safety. However, the study finds essentially little difference between the intervention (6%) and the control (6.7%) groups.

Patient Dissatisfaction

The rapid rehabilitation model is designed to provide for early discharge from the acute care setting with the intent to return patients to their optimal level of function

earlier in the clinical experience. For this reason, it was projected that patient dissatisfaction would decrease with the intervention group, meaning an inverse relationship would be present. The descriptive statistics finds no difference between the groups with a mean score of 3.5 on a 4.0 scale. The indicator contributes minimally to the theoretical model (.01) and is not retained in the final structural model.

Summary

This chapter presents research findings based on a quasi-experimental, cross-sectional and retrospective study designed to identify and quantify the relationships present in processes and outcomes inherent in healthcare transitions. Aging patients ≥ 65 are most vulnerable during these healthcare transitions as they receive a broad range of services across a multiplicity of providers, payers, and settings. A poorly executed transition can result in complications for the patient, duplication of tests and services, discharge delays, increased lengths of stay, and early readmissions to acute care setting. Management of care and accountability across settings is limited. Little is known about the value of the study intervention, termed rapid rehabilitation, to improve the delivery of healthcare services to this population. The study aims to establish predictors for successful healthcare transitions from an acute care hospital to rapid rehabilitation in a transitional care facility in the community, but finds limited explanatory power among the 6 selected indicators.

Although findings yield unexpected outcomes and statistical relationships, this research does provide information to suggest that hospital and clinical structure and leadership may impact the efficient and effective implementation of a rapid rehabilitation

program. Further research is needed to (1) examine indicators for successful transitions between hospital and community, (2) determine the value of rapid rehabilitation as a delivery model, (3) identify hospital structural factors that impact rapid rehabilitation as an intervention, (4) establish clinical criterion for patients in rapid rehabilitation delivery model, and (5) expand implications for hospital leadership. Chapter five provides a discussion to examine the theoretical implications for hospital and clinical structures, hospital leadership and the opportunities for health services research.

CHAPTER FIVE: DISCUSSION, IMPLICATIONS, LIMITATIONS, AND CONCLUSION

Discussion

This research addresses the state of healthcare services for the aging population and intends to establish a framework and quality indicators to measure the value of an innovative delivery model designed to optimize early discharge from the hospital through rapid rehabilitation. The study is aligned with new concepts in the marketplace and has been challenged by the same issues confronting the national framework to measure quality of care, and establish the value of healthcare service programs. This chapter discusses the alignment of this research to the national framework designed to measure safety and quality of care, and factors associated with theoretical implications for evidence based practice, hospital and clinical leadership, and future research.

Environment of Healthcare

The setting for this research is a healthcare environment that has been described as hyperturbulent, meaning there is constant change in economic policy, and shifts in the options, and mechanisms available to finance healthcare services. As a result, stakeholders are challenged to respond to rapid changes, and to develop strategies to address the efficient and effective operation of the organization (Rotarius & Liberman, 2000), while responding to congressional mandates for quality of care and value based purchasing initiatives. The environment is undergoing significant transition in the quality and integrity of healthcare data sets, the transparency of hospital information, and is experiencing an increasing interest in hospital measures and consensus of standards.

The current healthcare system remains fragmented across a broad array of settings (Coleman, Smith, Frank, Min, Parry, & Kramer, 2004), and continues to be plagued by gaps in quality of care and does not provide optimal care to the majority of American citizens (NCQA, 2004). Persons such as the aging patient, who are in need of continuous and often complex care, are very vulnerable to the fragmentation of care (Coleman, 2003). These gaps in healthcare services are especially troubling as aging patients and their families attempt to access quality care across multiple settings, providers, and payers. Most often, there is limited accountability and responsibility for care management during these healthcare transitions, and little integration between hospitals, outpatient services, and the community. As Covinsky noted in 2003, patients and families continue to fall through cracks in foundation of the healthcare system. Few stakeholders believe the expenditures for healthcare services are providing good value, and most believe the system is unsustainable in the present state beyond the next decade (Houmann, 2007).

Safe, Efficient, Effective Healthcare

Historically, measurements of efficiency and effectiveness in healthcare services have been quantified as morbidity and mortality rates for patients, regulatory restraints, and economic viability of hospitals. As late as the 1990s, studies found in the literature focused on managing the cost of care, capitation of expenses, and controlling the cost per member per month as administrative efforts sought to retain and expand market share. During the era of managed care, economists quantified the quality and value of

specific care by measuring the years of added patient life. There was limited focus on the quality of healthcare services (Thomas & Caldid, 2006).

Recommendations to ensure a safe healthcare environment, and well-established methods intended to improve quality of healthcare services have been available for years. However, the National Quality Forum (2006) reports hospitalized patients continue to experience adverse events, injury and death as a result of their healthcare experiences, and further reports there has been little improvement since the release of the original set of 30 safe practice recommendations in 2003 (NQF, 2006) This lack of significant progress on these measures suggests a disconnect between published standards and actual services.

National Framework for Quality

The purpose of this research is aligned with national goals to improve quality of care and current research to establish new frameworks to measure quality of care and the value of new delivery models in ways that are beneficial and meaningful to all stakeholders. The hospital providing the setting for this research has partnered with other stakeholders to develop and measure innovative delivery models exemplified by the rapid rehabilitation program used in this research.

As early as 1998, a presidential advisory board recommended the establishment of national goals to improve the quality of care within the healthcare system, and by 2001, the National Quality Forum (NQF) had developed a framework and set national goals for improvement. In 2002, a collaboration of public and private stakeholders came together to create the Hospital Quality Alliance (HQA). The mission of HQA (2007) is to

improve patient care by measuring the quality, costs, and value of hospital services, and by reporting these performance measures to general public. Table 26 summarizes national framework for quality of care and value based purchasing initiatives.

Table 26: National Framework to Measure and Report Quality of Healthcare Services

<i>Date</i>	<i>Organization</i>	<i>Framework</i>
1998	President's Advisory Commission on Consumer Protection and Quality in the Health Care Industry	Recommends national goals to improve quality of healthcare services
1990s	American Nurses Association	Develops National Database of Nursing Quality of Indicators
2001	Agency for Healthcare Research and Quality	Contracts with Institute of Medicine; recommends 20 priority areas
2001	National Quality Forum	Endorses IOM recommendations Expands to 22 priority areas Endorses priority for vulnerable populations
2002	Joint Commission on the Accreditation of Hospitals	Implements 18 quality of care standards Standards are specific to clinical diagnoses Collaboration of public and private
2002	Hospital Quality Alliance	stakeholders to measure and report hospital performance information
2004	National Quality Forum	Endorses consensus standards for 15 nursing sensitive measures
2007	Centers for Medicaid and Medicare	Designates hospital acquired conditions that preclude assignment to higher DRG

Hospital Measuring and Reporting

The national framework established in 2002 to measure and report on the performance of healthcare providers and hospitals provides a foundation for measurement that continues to expand the potential to measure quality and safety in the healthcare environment. In 2003 NQF embarked on a project to measure the impact

of nursing on safety and quality of care in the hospital setting. The study published a consensus on 15 standards for nurse sensitive indicators, and reports 3 of the 15 indicators are collected under the Hospital Quality Alliance program and reported to the public on Hospital Compare, the public reporting system managed by the Centers for Medicare and Medicaid Services. The 15-month study advanced the understanding of nurse sensitive indicators, but researchers acknowledge that multiple data sources, data collection, and measurement challenges provide unique opportunities for further research to ensure consistent and reliable data sets (NQF, 2007).

In the literature, attempts to measure the success of improvement projects, quality of care, and safety using hospital data sets have been limited. As demand for services, and economic costs have continued to escalate, stakeholders from a broad array of public and private organizations are coming together to improve the healthcare system through pay for performance, value based purchasing and reporting initiatives.

New Perspectives and Concepts

Driven by the Hospital Quality Alliance Program, new perspectives and concepts are evolving in the healthcare marketplace. The new perspectives merge the concepts of cost containment with the need to provide quality of care, and a safe healthcare environment, and provide for dual goals, effective and efficient healthcare services. The shift in thinking is a new concept of healthcare management. Referred to as pay for performance or P4P, the concept has generated collaboration among stakeholders to provide and purchase healthcare services that are based on value. Known as value based purchasing, the concept is supported by congressional legislation such as the

2005 Deficit Reduction Act (Thomas & Caldis, 2006). The need for value based purchasing and related research is projected to increase as population ages and baby boomer generation accesses increased healthcare services (Thomas & Caldis (2006).

Implications

This research serves to establish a framework to measure the value of rapid rehabilitation and to identify indicators to quantify effective and efficient healthcare services for the aging population. Driven by the need to better understand the value of rapid rehabilitation for the aging population, implications for this research are driven by the need within the study hospital to respond to the national framework to improve quality and safety of care, to somehow evaluate the new and innovative delivery models, and to establish the value of healthcare services within the study hospital.

Findings Support National Framework

Findings from this research suggest that (1) rapid rehabilitation supports the overarching national priority to serve a vulnerable population, (2) length of stay continues to be a standard measure for efficiency processes, and (3) patient safety measures provide promise as a measure of effectiveness outcome measures. Finally this research affirms that performance measures are challenged by access to quantified data sets across multiple sources, settings, and professions, and the overall quality and integrity of hospital data experienced by all healthcare service organizations. This implies an ongoing need for partnerships and research to establish a consensus of consistent measures and new statistical models that merges data across services and

disciplines, and perhaps hospitals and community services. Supported by the work of the Institute of Medicine, partnerships between public and private stakeholders represented by the Hospital Quality Alliance, and National Quality Forum, Centers for Medicare and Medicaid Services, and American Nurses Association are endorsing a consensus of standards that serve as data sources for health services research.

Innovation and New Delivery Models

Driven by escalating costs of care caused by ineffective and inefficient delivery of services, the Institute of Medicine (2008) reports that hospitals are seeking solutions to urgent healthcare policy issues and are working to determine which services provide safe, quality care at a value beneficial to all stakeholders. As hospitals strive to respond to emerging national standards for quality, and congressional mandates linked to pay for performance, new and innovative delivery models are being developed.

Research on care delivery models serves to identify common data elements in those models that are deemed successful and is pivotal to the development of strategies to ensure that a qualified nurse workforce is recruited and retained to meet the demand for quality health services. A partnership study in 2005 between Partners Healthcare and Health Workforce Solutions, reviewed 45 new delivery models, retaining 30 models who met inclusion criteria for the research. A final 10 models were deemed the most innovative. Among the delivery models, smaller hospitals, primary care teams, collaborative patient care management, transitional care models, and the concept of hospital at home offered the most potential to serve as models for future development of delivery systems (Kimball, Joynt, Cherner, & O'Neill, 2007).

The study hospital in this research is aligned with these new delivery models, and the new, innovative rapid rehabilitation model shows promise for delivery of healthcare services to a vulnerable population. However, these new delivery models must be measured comprehensively across a broad array of professional practice models and a multiplicity of services to determine the effective and efficient value of the services.

Nurses Contribution to Quality and Value

The contribution of nurses to the quality, safety, and value of healthcare services is well understood by all stakeholders and has been acknowledged by the National Quality Forum (2006) (Appendix C) and the American Nurses Association (2007) (Appendix D), which continues to partner with the Centers for Medicaid and Medicare on pay for performance initiatives to deliver patient centered care in a safe, effective, and efficient environment. Innovative delivery models are emerging from nursing and these models reflect the primary role of nursing in the delivery of health services.

The National Database of Nursing Quality Indicators (NDNQI) is a nursing quality measurement program developed by the American Nurses Association and managed by the University of Kansas, School of Nursing. The program is a repository of nurse sensitive data from greater than 1000 hospitals in the United States. Measures are collected on patient outcomes, nurse staffing data, nurse workforce demographics, and RN satisfaction with many of the indicators endorsed by the National Quality Forum and included on NQF nursing sensitive data set of measures. Comparison data and reports are provided quarterly to member hospitals. All measures are at the unit level. NDNQI

represents a valid and reliable data source for further research on healthcare quality initiatives (NDNQI, 2007).

Measurement Elements and Models

Despite the challenges to measure the value of rapid rehabilitation, the results from this research suggest that consensus standards evolving through the collaboration of the Hospital Quality Alliance and partnerships between the National Quality Forum, Centers for Medicaid and Medicare, and the National Database of Nursing Quality Indicators provide the opportunity for further research to determine what works in healthcare (Institute of Medicine, 2008) and in the innovative, rapid rehabilitation delivery model developed by the study hospital. Hospitals must continue an effort to comply with national measures and consensus standards and to support the synthesis of credible evidence into an understandable and usable format that is beneficial to determining what works in healthcare services (Institute of Medicine, 2008).

In current literature, standardized measures reflect an improvement in quality of care. A study of greater than 3000 hospitals between 2002 and 2004 found that performance measures improved ($p < 0.01$) in 15 of the 18 standardized measures for myocardial infarction, heart failure and pneumonia implemented by Joint Commission on Accreditation of Healthcare Organizations (JCAHO) (Williams, Schmaltz, Morton, Koss, & Loeb, 2005). The measures and data collection methods utilized in this study are based on well-defined measures and designed to allow for valid comparisons in national databases. However, the researchers describe considerable gaps were found

between medical guidelines and actual clinical practice suggesting that further research is necessary to bridge the gaps between standards of care and patient centered care.. As concluded by Selden & Sowa, (2004) there is ample opportunity to provide higher performance of healthcare services through the contribution of high quality research and to bridge the gaps in healthcare services during healthcare transitions.

Limitations

The limitations and challenges encountered by this research are consistent with the same challenges encountered at the national level. Barriers to health service data sets and the quality and integrity of hospital data are problematic. A comprehensive review of the literature by Maio, Goldfarb, Carter & Nash (2003) concluded that health service information and data sets on quality are key to better value-based strategies and purchasing activities. These barriers and limitations are (1) overwhelming number of measures, (2) concern about the validity and reliability of information, and (3) inconsistencies across reporting systems. Generally, hospitals and healthcare systems do not integrate administrative, clinical, financial, and information system data sets, meaning there is not a central repository for information that can be queried to correlate benchmarks or to collect large quantities of information for health services research (Advisory Board, 2005). This research found definitions for measures may not exist or may differ across data sets within the same organization and the format of information is critical to utilization by the end user.

Trust and Accountability for Hospital Data Sets

A review of four hospital data warehouses by the Advisory Board (2005) acknowledges that some characteristics of healthcare services are challenging to quantify and suggests validity of the data may be mistrusted by some stakeholders. Data warehousing systems may be costly, so hospitals must consider the potential of the applications and benefits of the technology. The Institute of Medicine (2008) has made recommendations to Congress for the development of a national clinical effectiveness program, with the mission to synthesize evidence-based information on quality of care outcomes. To improve trust, accountability, and credibility, the IOM recommends 8 essential principles for the program, (1) accountability, (2) efficiency, (3) objectivity, (4) scientific rigor, (5) consistency, (6) feasibility, (7) responsiveness, and (8) transparency. Beyond improving the quality and integrity of hospital data, the Institute of Medicine believes that healthcare stakeholders must be able to synthesize the data, to trust the validity and reliability of measures, and must be able to interpret the evidence as meaningful for the right patient and circumstances (Institute of Medicine, 2008).

Conclusions

In the most current literature, there is increasing evidence that health service organizations are making inroads to resolve the gaps in healthcare services, and to improve the quality and value of these services. The quest for performance excellence is evidenced by transformations and integration efforts, and a new body of health service research. The Baldrige National Quality Program (2006) supports health service organizations to improve the measurement of organizational performance and the

quality improvement of programs, processes, and personnel to improve competition in the marketplace. Components of the program provide guidelines, definitions and performance indicators for this research, and are reflected in the theories supporting this research, Theory of Servant Leadership, and Theory of the Learning Organization.

This research affirms that performance measures are challenged by access to quantified data sets across multiple sources, settings, and professions, and the overall quality and integrity of hospital data experienced by all healthcare service organizations. This implies an ongoing need for leadership, partnerships, and research to establish a consensus of consistent measures and new statistical models that merges data across services and disciplines, and perhaps hospitals and community services.

Theoretical Implications for Hospital and Clinical Structure

Results from this study yield unexpected statistical relationships, and limited explanatory power relative to the efficient and effective management of the aging population transitioned into rapid rehabilitation. However, the research does provide insight and substantively significant information to suggest that hospital and clinical leadership and structures impact the value of rapid rehabilitation as a delivery model for the aging population. To better understand these outcomes, the Donabedian model for structure, process, and outcome (Figure 3) is employed. In this model, structure is synonymous with the healthcare environment (hospital) where care is provided, process is the delivery method (rapid rehabilitation), and outcomes is the result of the services provided (indicators). Using the framework of Donabedian, the success of new delivery models, such as rapid rehabilitation, may be restricted or even impermanent if the

clinical and organizational structure is not altered or improved to accommodate the new processes (Castaneda-Mendez, 1999).

Since the Institute of Medicine described the serious issues of quality and safety within the nation's healthcare system in 1996 and called for a new health system for the 21st century, there has been an ongoing effort to redesign hospital and clinical services to improve quality of care based on the efficient, effective, timely, equitable, and safe delivery of patient centered care. Imperative to this effort are redesign challenges: (1) reengineering processes, (2) implementation of information systems, (3) improving the knowledge and skills of hospital management, (4) preparing an effective workforce, and finally (5) the coordination of care across services, locations, and providers (Institute of Medicine, 2001).

Presently, these redesign challenges are inherent in the operation of the study hospital, and create factors that are outside the scope of this research, but which may account for the unexpected outcomes and variations in the statistical analysis. In this hospital a number of new delivery models have been tested for the aging population, but have been impermanent (acute care for the elderly unit) or limited in scope and utilization (hospitalist program). The literature suggests that both programs have the potential to provide efficient and effective care to the aging population, but this research finds organizational and clinical redesign challenges have prevailed, and that evidence based practice has not been threaded into all operational and clinical initiatives.

Theoretical Implications for Hospital Leadership and Research

The literature review and preparation for this research confirms that new delivery models such as rapid rehabilitation have the potential to serve the vulnerable aging population, but finds limited answers to the questions posed in the research design. Are we making progress, as posed by the Balridge National Program (2006)? In this hospital setting, yes, leadership is providing organization and structure for new delivery programs, and processes of learning are in place to support quality improvement and safety initiatives. The hospital leadership program has been restructured and ongoing initiatives provide managers with the knowledge and skills to provide efficient and effective quality care through management and new safety initiatives. The nurse workforce is being prepared to provide elder sensitive care through education and the Hartford Institute of Geriatric Nursing and the Nurses Improving Care for Health System Elders (2008). Information on nurse sensitive indicators is being collected and utilized as benchmarks through the American Nurses Association and National Database of Nurse Sensitive Indicators (2008) housed at the University of Kansas. New information systems are being implemented and communication of patient information is improving across systems and providers. Based on this research, leadership is making steady progress to overcome the challenges outlined by the Institute of Medicine (2001) for system redesign, but poses implications for leadership. First among the implications for leadership is the need to thread evidence based practice procedures into hospital operations, clinical initiatives, and the professional workforce. Finally, there is an increasing need to establish data warehouses, and a central repository for health

services information so that valid and reliable information is utilized to draw inferences about performance of hospital systems (Selden & Sowa, 2004).

The hospital providing the setting for this research, operating in a turbulent healthcare environment, is making progress, but there is much work to be accomplished. Based on evolving consensus of quality and safety standards at the national level, researchers, in collaboration with hospital administrators, providers, and other stakeholders, have increasing opportunities to support the national agenda to improve the quality and safety of healthcare services. Health services research provides a scientific foundation for the management of healthcare services (Wan, 2002), and serves to ensure equitable, patient centered care to the aging population and to all patients and families served in our hospitals and communities.

APPENDIX A: VARIABLE DEFINITIONS WITH SPSS VALUE ASSIGNMENT

Variable	Definition	Assigned SPSS Value
Unique identifier		None
Transition to rapid rehabilitation	Intervention to optimize early discharge from acute care, return patient to optimal function	0=no 1=yes
Age	Age in years on admission	None
Gender	Female, male	0=female 1=male
Race	Race defined by Census Bureau, coded by hospital	0=white 1=nonwhite
DRG	Diagnosis Related Group, assigns number of define primary diagnosis	None
ICD9	International Code of Disease version 9, assigns, unique number to describe needs, characteristics of case, coded by hospital	None
Case mix index	Case Mix Index reflects complexity of services	None
Medicare-Medicaid	Qualified for Medicare and Medicaid, measures socioeconomic status	0=yes 1=no
Hospitalist	Clinical management by physician with hospitalist credentials during admission to acute care facility	0=no 1=yes
Geographical location	Location of patient home, coded by zip code, provides data on market services to community	None
County	Location of patient home, coded by county, provides data on market services to counties	1=Orange 2=Seminole 3=Osceola 4=Other
State	Location of patient home, coded by state provides data on market services to state	0=Florida 1=other
Length of stay	Measure of time in days patient is admitted to acute care hospital	None
Gross charges	Cost of care in dollars prior to contractual allowances	None
Discharge delays	Presence of an avoidable discharge delay from acute care setting to community	0=no 1=yes
Readmission	Readmission to acute care hospital within 30 days of discharge	0=no 1=yes
Safety/Falls	Patient fall occurring during the hospital experience	0=no 1=yes
Dissatisfaction	Gallup scores measured at the unit level	None

APPENDIX B: FREQUENCY OF DIGANOSIS RELATED GROUP ASSIGNMENT

DRG	MDC	Description	Group I: Intervention		Group II: Control	
			Frequency	Percent	Frequency	Percent
1	01	Craniotomy >17 w cc ^a	2	2.00	2	1.33
14	01	Intracranial hemorrhage or Cerebral Infraction	5	5.00	7	4.67
15	01	Nonspecific CVA & pre-cerebral occlusion w/o infarction	1	1.00	1	0.67
18	01	Cranial & peripheral nerve disorders	1	1.00	1	0.67
28	01	Traumatic stupor & coma w cc	1	1.00	1	0.67
34	01	Other disorders of the nervous system w cc	1	1.00	1	0.67
75	04	Major chest procedures	1	1.00	1	0.67
78	04	Pulmonary embolism	2	2.00	4	2.67
88	04	Chronic obstructive pulmonary disease	3	3.00	3	2.00
89	04	Simple pneumonia & pleurisy	5	5.00	6	4.00
104	05	Cardiac valve, major cardiothoracic procedures, w cardiac cath	2	2.00	1	0.67
105	05	Cardiac valve, major cardiothoracic procedures, w/o cardiac cath	1	1.00	1	0.67
107	05	Coronary Bypass w cardiac cath	6	6.00	5	3.33
109	05	Coronary bypass w/o PTCA or cardiac cath	2	2.00	3	2.00
110	05	Major cardiovascular procedures w cc	1	1.00	1	0.67
121	05	Circulatory disorders, AMI, major complications, discharged alive	1	1.00	1	0.67
125	05	Circulatory disorders except AMI, cardiac cath w/o complex diagnosis	1	1.00	1	0.67
127	05	Heart Failure & Shock	4	4.00	10	6.67
130	05	Peripheral vascular disorders w cc	2	2.00	2	1.33
138	05	Cardiac arrhythmia, conduction disorders w cc	2	2.00	3	2.00
141	05	Syncope, collapse w cc	2	2.00	7	4.67
148	06	Major small, large bowel procedures w cc	4	4.00	4	2.67
150	06	Peritoneal adhesiolysis w cc	1	1.00	1	0.67
174	06	G.I. hemorrhage w cc	2	2.00	2	1.33
183	06	Esophagitis, gastroenteritis, misc, digestive disorders age>17 w/o cc	1	1.00	1	0.67
203	07	Malignancy of hepatobiliary system or pancreas	1	1.00	3	2.00
209	08	Major joint, limb reattachment procedures of lower extremity	2	2.00	5	3.33
210	08	Hi, femur procedures except major joint age>17 w cc	4	4.00	5	3.33
216	08	Biopsies of musculoskeletal system, & connective tissue	2	2.00	4	2.67
218	08	Lower extreme & humer proc except hip, foot, femur age>17 w cc	4	4.00	7	4.67

239	08	Pathological fractures & musculoskeletal & conn tiss malignancy	3	3.00	5	3.33
253	08	Fx, sprn, strn & disl of uparm, lowleg, ex foot, age>17 w cc	1	1.00	1	0.67
254	08	Fx, sprn, strn & disl of uparm, lowleg, ex foot, age>17 w/o cc	1	1.00	2	1.33
256	08	Other musculoskeletal system & connective tissue diagnoses	1	1.00	1	0.67
277	09	Cellulitis age>17 w cc	1	1.00	2	1.33
296	10	Nutritional & misc metabolic disorders age>17 w cc	2	2.00	4	2.67
316	11	Renal failure	2	2.00	5	3.33
415	18	O.R. procedure fir infectious & parasitic diseases	1	1.00	3	2.00
416	18	Septicemia age>17	5	5.00	16	10.67
429	19	Organic disturbances & mental retardation	1	1.00	2	1.33
452	21	Complications of treatment w cc	1	1.00	1	0.67
461	23	O.R. Proc w diagnosis or other contact w health services	1	1.00	1	0.67
462	23	Rehabilitation	2	2.00	6	4.00
475	04	Respiratory system diagnosis with ventilator support	2	2.00	4	2.67
497	08	Spinal fusion except cervical wcc	2	2.00	0	0.00
498	08	Spinal fusion except cervical w/o cc	3	3.00	2	1.33
515	05	Cardiac defibrillator implant w/o Cardiac cath	2	2.00	0	0.00
519	08	Cervical spinal fusion w cc	1	1.00	0	0.00
534	01	Extracranial procedures w/o cc	1	1.00	1	0.67
Total			100	100.00	150	100.00

Note: ^a Denotes with or without complication or comorbid condition, Ingenix, (2005)

APPENDIX C: NATIONAL QUALITY FORUM AND NURSE SENSITIVE CARE

National Quality Forum (NQF) 15:
Consensus Standard for Nursing Sensitive Care
Measures

Patient Centered Outcomes	<p>Failure to rescue surgical inpatients with treatable complications</p> <p>Pressure ulcer prevalence</p> <p>Falls prevalence</p> <p>Falls with injury</p> <p>Restraint prevalence (vest and limb only)</p> <p>Urinary catheter associated urinary tract infections, intensive care patients (ICU)</p> <p>Central line catheter associated blood stream infection rates for ICU and high risk nursery (HRN) patients</p> <p>Ventilator associated pneumonia for ICU patients and HRN patients</p>
Nurse Centered Interventions	<p>Smoking cessation counseling myocardial infarction</p> <p>Smoking cessation counseling for heart failure</p> <p>Smoking cessation counseling for pneumonia</p>
System Centered Measures	<p>Skill mix of the Nurse Workforce, Registered Nurse (RN), Licensed Vocational/Practical (LVN/LPN, unlicensed assistive personnel (UAP) and contract</p> <p>Nursing care hours per patient day for RN, LPN, UAP</p> <p>Practice Environment Scale, and Nurse Work Index (composite and five subscales)</p> <p>Voluntary Turnover</p>

(National Quality Forum, 2007)

APPENDIX D: NATIONAL DATABASE OF NURSING QUALITY INDICATORS

Nurse Quality Indicators	Definition
Catheter Associated Urinary Tract Infection (CAUTI)	Patient developed hospital acquired symptomatic urinary tract infection or asymptomatic bacteriuria as defined by Centers for Disease Control at time or within 7 days of removal of an indwelling catheter
Central Line Associated Bloodstream Infection (CLABSI)	Patient developed a hospital acquired blood stream infection as defined by Centers for Disease Control at time of or within 48 hours after removal
Nurse Turnover	Number of permanent , direct care nursing staff that leave their position for any reason. Indicatoris further defined by the Adapted NQF Voluntary Rate and the Magnet Controllable Turnover Rate
Nursing Care Hours Patient Days	Nursing care hours per patient day measures Patient days measured in hours is most accurate measurement, but other methods take into account calculations for short stay, multiple census
Patient Falls	Unplanned descent to the floor or other extension of the floor with or without injury
Pain Assessment/Intervention / Reassessment (AIR) Cycle	Indicator collected for pediatric and neonatal populations, measured as total number of pain assessment cycles documented within 24 hours.
Peripheral Intravenous (PIV) Infiltration	Indicator collected for pediatric and neonatal populations, measured as the total number of unplanned administration of a nonvesicant into surrounding tissue, and total number of unplanned administration of a vesicant into surrounding tissue
Physical Restraint Prevalence	Prevalence of any physical, mechanical restraint which can not be easily removed by patient and restricts freedom of movement or normal access to body
Physical/Sexual Assault	Total number of assaults, assaults with injury within a calendar month
Pressure Ulcer Prevalence	Hospital acquired localized injury to skin or underlying tissue as a result of pressure or pressure/friction
RN Education	Highest nursing degree or US equivalent for registered, national certification by a national nursing organization
Ventilator Associated Pneumonia (VAP)	Ventilator acquired pneumonia that is clinically defined, has specific laboratory findings or is present in an immunocompromised patient

(American Nurses Association, 2008)

LIST OF REFERENCES

- Advisory Board (2001). *Case management: Optimizing care across the continuum*. Washington, DC: Author. Retrieved June 10, 2003 from <http://www.advisoryboard.com>
- Advisory Board (2001). *The impact of the aging population on health care delivery systems*. Washington, DC: Author. Retrieved June 10, 2003 from <http://www.advisoryboard.com>
- Advisory Board (2005). *Leveraging data warehouses to improve hospital operations*. Washington, DC: Author. Retrieved October 23, 2007 from <http://www.advisoryboard.com>
- Advisory Board (2006). *Geriatric care: Hospitalists poised to fill elder-gap but are under trained, underutilized in geriatrics*. Washington, DC: Author. Retrieved November 30, 2006 from <http://www.advisory.com>
- Agency for Health Care Administration (2004). *2004 Florida health insurance study*. Retrieved November 06, 2004, from http://www.fdhc.state.fl.us/executive/communications/press_releases/11032004.
- Agency for Healthcare Research and Quality (2005). *30 safe practices for better health care*. Retrieved March 2005 from www.ahrq.gov
- Agency for Healthcare Research and Quality (2006). *Effective health care*. Washington, DC: Author. Retrieved October 9, 2006 from www.effectivehealthcare.ahrq.gov
- American Geriatric Society (1999). *Geriatric rehabilitation*. American Geriatric Association position statement. Retrieved June 12, 2007 from www.americangeriatrics.org

- American Geriatric Society (2003). *Improving the quality of transitional care for persons with complex care needs*. American Geriatric Society Position Statement. Retrieved July 28, 2005 from www.americangeriatrics.org
- American Hospital Association (2002). *The state of hospitals' financial health*. Retrieved June 11, 2003 from <http://www.aha.org>
- American Hospital Association (2007). *Baby boomers to challenge and change tomorrow's health care*. Retrieved October 23, 2007 from <http://www.aha.org>
- American Hospital Directory (2002). *Medicare prospective payment system*. Retrieved October 7, 2007 from www.ahd.com
- American Nurses Association (2007). National database of nursing quality indicators. Kansas City, KS: Author.
- Argyris, C. & Schon, D. (1996). *Organizational Learning II: Theory, Method, and Practice*. Reading, MA: Addison Wesley.
- Arnold, S.B. & Harrison, M. (2005). *Transforming health systems through leadership, design, and incentives*. Invitational meeting sponsored by Agency for Healthcare Research and Quality, Centers for Medicare and Medicaid Services, National Cancer Institute, and Health Affairs, Rockville, MD.
- Atkins, D., Fink, K., & Slutsky, J. (2005). Better information for better health care: The evidence-based practice center program and the Agency for Healthcare Research and Quality. *2005 American College of Physicians*, 142. 1035-1041
- Bardram, L., Funch-Jensen, P., & Kehlet, H. (2000). Rapid rehabilitation in elderly patients after laparoscopic colonic resection. *British Journal of Surgery*, 87, 1540-1545.

Balridge National Quality Program (2006). *Balridge health care criteria for performance excellence*. Gaithersburg, MD: Author.

Berger, R.A., Jacobs, J.J., Meneghini, R.M., Valle, C.D., Paprosky, W., * Rosenberg, A.G. (2004). Rapid rehabilitation and recovery with minimally invasive total hip arthroplasty. *Clinical Orthopaedics and Related Research*, 428, 239-247.

Best, A., Stokols, D., Green, L.W., Leischow, S., Holmes, B., & Buchholz, K. (2003). An integrative framework for community partnering to translate theory into effective health promotion strategy. *American Journal of Health Promotion*, 18, 168-176.

Bierman, A., Spector, W., Atkins, D., Basu, J., Clancy, C., Gross, M., Lebbon, A., Moody, L., Rhoades, J., Rothstein, D., Sangl, J., Schone, B., & William, C. (2001). *Improving the health care of older Americans*. Retrieved May 2001 from <http://www.ahrq.gov/research/olderam>

Birkmeyer, J.D., Dimick, J.B., & Birkmeyer, N.J. (2004). Measuring the quality of surgical care: structure, process, or outcome? *Journal of the American College of Surgeons*, 198, 626-632.

Bloom, B.S., Chhatre, S., Jayadevappa, R. (2004). Cost effects of a specialized care center for people with Alzheimer's disease. *Journal of Alzheimer's Disease & Other Dementias*, 19, 226-232.

Bradley, E.H., Holmboe, E.S., Mattera, J.A., Roumanis, S.A., Radford, M.J., & Krumholz, H.M. (2004). Data feedback efforts in quality improvement: Lessons learned from US hospitals. *Quality & Safety in Health Care*, 13, 26-31.

Branch, L.G. (2001). Community Long-term care services: what works and what doesn't. *The Gerontologist*, 41, 305-306.

Burns, L., & Pauly, M.V.(2002). Integrated delivery networks: A detour on the road to integrated health care? *Health Affairs*, 21, 128-143.

Byrne, B.M. (2001). *Structural equation modeling with Amos: Basic concepts, applications, and programming*. Mahwah, NJ: Lawrence Erlbaum Associates.

Caplan, G.A., Williams, A.J., Daly, B., & Abraham, K. (2004). A randomized, controlled trial of comprehensive geriatric assessment and multidisciplinary intervention after discharge of elderly from the emergency department. *Journal of the American Geriatric Society*. 52, 1417-1423

Centers for Medicare & Medicaid (2006). *The centers for Medicare & Medicaid services at a glance*. Washington, DC: Author.

Casalina, L., Gillies, R.R., Shortell, S.M., Schmittdiel, J.A., Bodenheimer, T., Robinson, J.C. et al. (2003). External incentives, information technology, and organized processes to improve health care quality for patients with chronic diseases. *The Journal of the American Medical Association*, 289, 434-441.

Castaneda-Mendez,K. (1999). Performance measurement in health care. *Statgraphics Centurion XV*. Retrieved July 7, 2007 from <http://www.qualitydigest.com>

Centers for Medicare & Medicaid (2006). *The Centers for Medicare & Medicaid Services at a glance*. Washington, DC: Author.

Centers for Medicare & Medicaid (2007). *Annual report of the boards of trustees of the federal hospital insurance and federal supplementary medical insurance trust funds*: Washington, DC: Author.

Cohen, M.A. (1998). Emerging trends in the finance and delivery of long-term care: public and private opportunities and challenges. *The Gerontologist*, 38, 80-89.

- Coleman, E.A. (2003). Falling through the cracks: Challenges and opportunities for improving transitional care for persons with continuous complex care needs. *Journal of the American Geriatric Society*, 51, 549-555.
- Coleman, E.A., Smith, J.D., Frank, J.C., Min, S.J., Parry, C., & Kramer, A.M. (2004). Preparing patients and caregivers to participate in care delivered across settings: The care transitions intervention. *The American Geriatrics Society*, 52, 1817-1825.
- Congressional Budget Office (2002). *The impact of social security and Medicare on the Federal budget* (Issue Brief No. 6). Washington, DC: Author.
- Covinsky, K.E. & Johnston, C.B. (2003). Envisioning better approaches for dementia care. *Annals of Internal Medicine*, 145, 780-781.
- Cromwell, J., Donoghue, S., & Gilman, B.H. (2002). Expansion of Medicare's definition of post-acute care transfers. *Health Care Financing Review*, 24, 95-108.
- Data Advantage Corporation (2002). *US hospitals' Medicare costs now exceed reimbursement for top ten DRGs*. Louisville, KY: Author. Retrieved November 5, 2007 from www.data-advantage.com
- Data Advantage Corporation (2005). *Latest Medicare data show hospital losses growing as costs continue to outpace reimbursement*. Louisville, KY: Author. Retrieved November 5, 2007 from www.data-advantage.com
- Diamond, H.S., Goldberg, E., & Janosky, J.E. (1998). The effect of full-time faculty hospitalists on the efficiency of care at a community teaching hospital. *Annals of Internal Medicine*, 129, 197-203.

- Eddy, D.M. (1998). Performance measurement: problems and solutions. *Health Affairs*, 17, 7-25
- Feachem, R.G.A, & Sekhri, N.K. (2005). Moving towards true integration. *British Medical Journal*. 330. 787-788.
- Feder, J., Komisar, H.L., & Niefeld, M. (2000). Long-term care in the United States: an overview. *Health Affairs*, 19, 40-54.
- Finkler, S.A., & Ward, D.M. (2003). The Case for the use of evidence-based management research for the control of hospital costs. *Health Care Management Review*, 28, 348-365.
- Finlayson, M. (2002). Changes predicting long-term care use among the oldest-old. *The Gerontologist*, 42, 443-453.
- Florida Department of Elder Affairs (2004). *Florida, providing managed care organizations with financial incentives to expand community care and limit nursing home care: Long term care community diversion*. Retrieved February 18, 2005 from <http://www.cms.gov>
- Florida Department of Elder Affairs (2006). *2006 Legislation*. Retrieved March 3, 2007 from <http://elderaffairs.state.fl.us/>
- Florida Hospital Association (2002). *FHA eye on the healthcare workforce; Florida's nursing shortage continues*. Retrieved January 23, 2003 from <http://www.fha.org>
- Florida Hospital Association (2003). *Caring for uninsured non-citizens*. Retrieved July 29, 2003 from <http://www.fha.org>
- Florida Medicaid (2007). *Longterm Care Insurance and Medicaid*. Retrieved October 21, 2007 from <http://www.floridamedicaid.com>

- Fottler, M.D., Hernandez, S.R., & Joiner, C.L. (1994). *Strategic management of human resources in health services organizations*. Albany, New York: Delmar Publishers
- Gabow, P., Eisert, S., & Wright R. (2003). Denver Health: A model for the integration of a public hospital and community health centers. *Annals of Internal Medicine*. 138, 150.
- Garson, G. D. (2007). *Structure equation modeling*. Retrieved July 7, 2007 from <http://www2.chass.ncsu.edu/garson/pa765/structur.htm>.
- Godden, S., & Pollock, A.M. (2001). The use of acute hospital services by elderly resident of nursing and residential care homes. *Health and Social Care in the Community*. 9, 367-374.
- Granger, B. & Chulay, M. (1999). *Research strategies for clinicians*. Norwalk, CT: Appleton and Lange.
- Greenleaf (2002). *Servant leadership*. Mahwah, NJ: Paulist Press.
- Grines, C.L., Marsalese, D.L., Brodie, B., Griffin, J., Donohue, B., Costantini, C.R., et al (1998). Safety and cost-effectiveness of early discharge after primary angioplasty in low risk patients with acute myocardial infarction: PAMI II investigators, primary angioplasty in myocardial infarction. *Journal of the American College of Cardiology*, 31, 967-972.
- Havens, D.S. & Aiken, L.H. (1999). Shaping systems to promote desired outcomes. *Journal of Nursing Administration*, 29, 14-20.
- HMO Workwork Group on Care Management (2004). *One patient, many places: Managing healthcare transitions*. American Association of Health Plans Foundation, Washington, DC: Author.

- Li, h., Morrow-Howell, N., & Proctor, E.K. (2004). Post-acute home care and hospital readmission of elderly patients with congestive heart disease. *Health & Social Work, 29*, 4, 275-285.
- Hospital Quality Alliance (2007). *Hospital Quality Alliance: Improving care through information*. Retrieved January 3, 2007 from www.cms.hhs.gov/hospitalqualityinits/15_hospital_quality_alliance.asp
- Houmann,L. (2007). Are you ready to shape the future? *The Pulse, Florida Hospital, Orlando, FL*, 3, 1.
- Ingenix (2004). Hospital contractual allowances are trending upward, latest research shows. *Managed Healthcare Executive*, March, 33-34.
- Institute of Medicine (1999). *To err is human: building a safer health system* (Report Brief). Washington, DC: Author
- Institute of Medicine (2001). *Crossing the quality chasm: A new health system for the 21st century* (Report Brief). Washington, DC: Author
- Institute of Medicine (2008).*Knowing what works in health care: A roadmap for the nation* (Report Brief). Washington, DC: Author.
- Joint Commission on the Accreditation of Hospitals (2007). *Improving America's hospitals: the Joint Commission's annual report on quality and safety*. Retrieved January 3, 2008 from <http://www.jointcommissionreport.org/>
- Joseph, M.L.(2007). *Innovativeness in nursing: A phenomenological and constructivist study*. Unpublished doctoral dissertation, Capella University, Minnesota.
- Kane, R.A. (2001). Long-term care and a good quality of life: bringing them closer together. *The Gerontologist*, 41, 293-304.

- Keehan, S.A., Lazenby, H.C., Zezza, M. A., & Catlin, A.C. (2004). Age estimates in the national health accounts. *Health Care Financing Review*, 1, 1-16
- Kimball, B., & O'Neil, E. (2002). *Health care's human crisis: the American nursing shortage* (Health Workforce Solutions). Princeton, NJ: Robert Wood Johnson Foundation.
- Kimball, B, Joynt, J., Cherner, D., & O'Neill, E. (2007). The quest for new innovative care delivery models. *Journal of Nursing Administration*, 37, 392-398.
- Knickman, J.R. & Snell, E.K. (2002). The 2030 problem: caring for aging baby boomers. *Health Services Research*, 37, 849-884.
- Landefeld, C.S.(2003). Improving health care for older persons. *Annals of Internal Medicine*, 139, 421-424.
- Leapfrog Group (2004). *Measuring provider efficiency version 1.0: A collaborative multi-stakeholder effort*. Retrieved January 7, 2005 from www.leapfroggroup.org
- Lim, S.C., Doshi, V., Castasus, B., Lim, J.K.H., & Mamun, K. (2006). Factors causing delay in discharge of elderly patients in an acute care hospital. *Annals of the Academy of Medicine*, 35, 27-32.
- Maio, V., Goldfarb, N.I., Carter, C., & Nash, D.B. (2003). *Value-based purchasing: A review of the literature* (Rep. No. 636). New York, NY: Common Wealth Fund.
- Mauch, J.E. & Park, N. (2003). *Guide to the successful thesis and dissertation: A handbook for ftudents and Faculty*. New York: Marcel Decker.
- McCracken, M.J., & McIlwain, T.F., & Fottler, M.D. (2001). Measuring organizational performance in the hospital industry: An exploratory comparison of objective and subjective methods. *Health Services Management Research*, 14, 211-9

- McDonald, M.D. (2001). The hospitalist movement: Wise or wishful thinking? *Nursing Management*, 32, 30-31
- Miller, E.A., & Weissert, W.G. (2003). Models, measures, and methods: Variability in aging research. *Home Health Care Services Quarterly*, 22, 43-67.
- Miller, E.A., & Weissert, W.G. (2003). Strategies for integrating Medicare and Medicaid: Design features and incentives. *Medical Care Research and Review*, 60, 123-157.
- Miller, S.K. (2002). Acute care of the elderly units: A positive outcomes case study. *AACN Clinical Issues*, 13, 34-42
- Mooney, L.A., Knox, D. & Schacht, C. (2002). *Understanding social problems* (3rd ed.). Belmont, CA: Wadsworth Publishing.
- Muhlbaier, L.H.(2003). *HIPPA training handbook for researchers: HIPAA and clinical trials*. Marblehead, MA: HCPPro.
- National Committee for Quality Assurance (2004). *The state of health care quality: 2004*. Washington, DC: Author.
- National Committee for Quality Assurance (2006). *The state of health care quality 2006: Executive Summary*. Retrieved September 16, 2007 from www.ncqa.org
- National Committee for Quality Assurance (2007). *The state of health care quality 2007: Executive Summary*. Retrieved February 11, 2007 from www.ncqa.org
- National Quality Forum (2002). *Establishing priorities, goals, and a measurement framework for assessing value across episodes of care*. Washington, DC: Author. Retrieved February 12, 2008 from www.qualityforum.org/projects/ongoing/priorities

- National Quality Forum (2004). *National priorities for healthcare quality measurement and reporting*. Washington, DC: Author.
- National Quality Forum (2006). *Safe practices for better healthcare 2006 update: A consensus report* (ISBN 1-933875-07-0). Washington, DC: Author.
- National Quality Forum (2007). *Nursing Performance measurement and reporting: A status report* (Issue Brief No. 5. Washington, DC: Author.
- National Quality Forum (2007). *Tracking NQF-endorsed consensus standards for nursing-sensitive care: A 15-month study*. Washington, DC: Author.
- O'Mahony S., Blank, A.E., Zallman L., & Selwyn, P.A. (2005). The benefits of a hospital-based inpatient palliative care consultation service: preliminary outcome data. *Journal of Palliative Medicine*, 8, 1033-9
- Pallant, J. (2001). *SPSS survival manual*. Buckingham: University Press.
- Palmer, R.M., Counsell, S.R., & Landefeld, S.C. (2003). Acute care for the elderly: Practical considerations for optimizing health outcomes. *Disease Management and Health Outcomes*, 11(8), 607-617.
- Pan, L., Fergusson, D., Schweitzer, I., & Hebert, P.C. (2005). Ensuring high accuracy of data abstracted from patient charts: the use of a standardized medical record as a training tool. *Journal of Clinical Epidemiology*, 58, 918-923.
- Parker, S.G., Fadayevatan, R., Lee, S.D. (2006). Acute hospital care for frail older people. *Age and Aging*, 35, 551-552.
- Phillips-Harris, C. (1996). The integration of primary care and case management in chronic disease. *Quality Management in Health Care*, 5, 115-120

- Polit, D.F. & Beck, C.T. (2004). *Nursing research: Principles and methods*. Philadelphia, PA: Lippincott, Williams, and Wilkins.
- Robinson, K.M. (1997). Family caregiving: who provides the care and at what cost? *Nursing Economics*, 15, 243-247.
- Rotarius, T. & Liberman, A. (2000). Stakeholder management in a hyperturbulent health care environment. *Health Care Manager*, 19, 1-7.
- Rotarius, T., Trujillo, A., Unruh, L., Fottler, M.D., Liberman, A., Morrison, S.D., Ross, D., & Cortelyou, K. (2002). Uncompensated care and emergency department utilization: A local study having national implications. *Health Care Manager*, 21, 1-38.
- Rueben, D.B., Roth, C., Kamberg, C., & Wenger, N.S. (2003). Restructuring primary care practices to manage geriatric syndromes: The ACOVE-2 intervention. *Journal of the American Geriatric Society*, 51, 1787-1793
- Schiff, G.D., & Rucker, T.D. (2001). Beyond the structure-process-outcome: Donabedian's seven pillars and eleven buttresses of quality. *Journal of Quality Improvement*, 27, 169-174.
- Selden, S.C. & Sowa, J.E. (2004). Testing a multi-dimensional model of organizational performance : Prospects and problems. *Journal of Public Administration Research and Theory*, 14, 395-415.
- Shafritz, J.M. & Ott, J.S. (1996). *Classics of Organization Theory* (4th ed.). Orlando: Harcourt Brace and Company.

- Shinkus-Clark, J. (2004). An aging population with chronic disease compels new delivery systems focused on new structures and practices. *Nursing Administration Quarterly* 28, 105-115.
- Smith, M.K. (2001). Peter Senge and the learning organization. *The Encyclopedia of Informal Education*. Retrieved October 23, 2007 from www.infed.org/thinkers/senge.htm
- Smolenyak, M. & Majumdar, A. (1992). What is leadership? *Journal for Quality and Participation*, July-August, 28-32.
- Spears, L.C. (2003). Servant leadership: Quest for caring learning. *Greenleaf Center for Servant Leadership*. Retrieved May 10, 2003 from <http://www.greenleaf.org/>
- Spillman, B.C., & Pezzin, L.E. (2000). Potential and active caregivers: changing networks and the sandwich generation. *Milbank Quarterly*, 78, 347-374.
- Straub, B. (2008). *National spotlights: Public reporting and pay for performance-nursing sensitive indicators*. Presented at American Nurses Association National Database of Nursing Quality Indicators Conference, Orlando, FL, January 30, 2008.
- Stoelting, R. (2002). *Structural equation modeling/path analysis*. Retrieved March 16, 2008 from <http://www.userwww.sfsu.edu/~efc/classes/bio710>
- Swearingen, S. (2004). *Nursing leadership characteristics: Effect on nursing Job satisfaction and retention of baby boomer and generation x nurses*. UMI Dissertation Services No. 3163629.

- Timms, J., Parker, V.G. Fallat, E. H., & Johnson, W.H. (2002). Documentation of characteristic of early hospital readmission of elderly patients: A challenge for inservice educators. *Journal for Nurses in Staff Development*, 18, 136-143.
- Thomas, F.G. & Caldis, T. (2006). Emerging issues of pay-for-performance in health care. *Health Care Financing Review*, 29, 1, 1-3.
- University of Massachusetts Center for Health Policy and Research (2004). *2001 Real Choice Systems Change Grant*. Retrieved April 12, 2005 from <http://www.massrealchoices.org/realchoice/index.cfm>
- Unruh, L.Y. & Byers, J.F. (2002). Hospital downsizing: international experiences and perspectives. *Nursing and Health Policy Review*, 1, 117-151.
- U.S. Census Bureau (2003). *People 65 years and over by ratio of income to poverty and state*. Retrieved July 11, 2003 from the worldwide web: www.census.gov/hhes/poverty/65+inctopov.html
- U.S. Census Bureau (2007). *About 2010 census*. Retrieved February 23, 2008 from the worldwide web: www.census.gov/2010census_2010_census
- U.S. Department of Health and Human Services (2007). *National Healthcare Quality Report* (AHRQ Publication No. 08-0040, pp. 1-144). Rockville, MD: Author.
- Vabey, D.C., Corser, W.D., & Brennan, P.F. (2001). Publicly available healthcare databases for administrative strategic planning. *Journal of Nursing Administration*, 31, 1, 9-15.
- Visiting Nurse Association of New York, (2004). New York state, *Providing coordinated services to older adults in their homes: An interdisciplinary approach to managed long term care*. Retrieved February 18, 2005 from <http://www.cms.gov>

- Wald, H., Huddlestone, J., & Kramer, A. (2006). Is there a geriatrician in the house? Geriatric approaches in hospitalist programs. *Journal of Hospital Medicine*, 1, 29-35.
- Wan, T.T.H. (1995). *Analysis and evaluation of health care systems: An integrated approach to managerial decision making*. Baltimore, MD: Health Professions Press.
- Wan, T.T.H. (2002). *Evidenced-based health care management: multivariate modeling approaches*. Norwell, MA: Kluwer Academic Publishers.
- Wan, T.T.H. & Connell, A.M. (2002). *Monitoring the quality of health care: Issues and scientific approaches*. Norwell, MA: Kluwer Academic Publishers.
- Wan, T.T.H, Lin, Y.J., & Ma, A. (2002). Integration mechanisms and hospital efficiency in integrated health care delivery systems. *Journal of Medical Systems*, 26, 127-143
- Weiner, J.M. & Stevenson, D.G. (1998). State policy on long-term care for the elderly. *Health Affairs*, 17, 81-100.
- Weissert, W.G., Hirth, R.A., Chernew, M.E., Diwan, S., & Kim, J. (2003). Case management : Effects of improved risk and value information. *Gerontologist*, 43, 806-807.
- Willeumier, D. (2004). Advocate health care: a system wide approach to quality and safety. *Joint Commission Journal on Quality & Safety*, 30, 559-66.
- Williams, Schmaltz, Morton, Koss, & Loeb (2005). Quality of care in U.S. hospitals as reflected by standardized measures, 2002-2004. *The New England Journal of Medicine*, 353, 255-264.

Winter Park Health Foundation (2000). *Elder care and the workplace: a report to the community*. Winter Park, FL: Author.

Worrell, D. (1995). The learning organization: Management theory for the information age or new age fad? *The Journal of Academic Librarianship*, September, 351-357.

Yemane, A. & Hill, I. (2002). *Recent changes in health policy for low-income people in Florida*. Urban Institute, Washington, D.C. Retrieved February 18, 2006 from <http://www.urban.org/url.cfm?ID=310473>

Yu, F., & Richmond, T. (2005). Factors affecting outpatient rehabilitation outcomes in elders. *Journal of Nursing Scholarship*, 37, 229-236.